

1314



# **RESCUE** *TECH*

RESCUE EQUIPMENT FOR THE TECHNICAL ROPE PROFESSIONAL



US\$2.00

540° Belay _____	46	Harness, Victim _____	29	Rope, NFPA _____	2, 3, 7
ACCESS™ Lifeline _____	3, 4	Hauling Kits _____	54, 55, 57	Rope, Polypropylene _____	4
ADVANTAGE Rescue Harness _____	24	Headlamps _____	124, 125	Rope, Rescue _____	2, 3
Air Cart _____	136	Helmets, Rescue _____	121, 122, 123	Rope, Sewn Eye _____	5
Anchor Plates _____	49, 50	Helmets, Water _____	105	RUTH LEE™ Manikins _____	83 - 86
ARACHNIPOD Multipod _____	65 - 69	Hoist, Tripod _____	68, 70	Scaffold Hooks _____	35
Ascenders _____	43, 44	I'D™ _____	46	SEARCHCAM® _____	134
Backboards _____	79	Kits, Rescue _____	51 - 57	Search Kits _____	12 - 14
Bags, Equipment _____	11, 89-92	KIWI™ Helmets _____	121, 122	Seat Harness _____	27, 28
Bags, Gear _____	92, 93	Knee Pads _____	127	Shock Absorber _____	59
Bags, Rope _____	11	Knives _____	113, 128	Simulaids™ _____	87, 88
Belay Device _____	46	Ladder, Webbing _____	64	SKED™ _____	82
Books, Rescue _____	119, 120	Landing Zone Kit _____	129	SKYHOOK™ Winch _____	71
Books, Water Rescue _____	118	Lanyards _____	18, 61, 62	Slings _____	58 - 63
Boots _____	107	LARKIN Frame _____	70	Snorkel _____	105
Cable Umbilical _____	132	Lifeline, Vertical _____	5	SPIN-LOCK™ Rescue Kits _____	56
Carabiners, Aluminum _____	33, 34	Lights, Dive _____	106, 129	Spreader Plate _____	26
Carabiners, Steel _____	31, 32, 35	Lights, Handheld _____	129	Stretchers, Basket _____	73 - 75
Command Board _____	120	Lights, Strobe _____	106, 129	Supplied Air Systems _____	136
Communication Equipment _____	130, 131	Links _____	32	Swivel _____	36
Confined Space Rescue Kits _____	53, 56	Litter Bridles _____	76	Throw Bags _____	111, 112
CON-SPACE _____	130 - 134	Litter Trailer _____	72	Tower Harness _____	24, 25
Cord, Prusik _____	4, 50	Litter Wheel _____	73	Tower Rescue System _____	57
CORONA™ Escape Belt _____	20	Load Release Strap _____	60	Tripod _____	66, 70
D2 Escape Descender _____	19	LSP Halfback _____	81	VANGUARD II™ Rescue Harness _____	23, 27
D4 Descender / Belay Device _____	46	Manikins, Training _____	83 - 88	Ventilation Equipment _____	135
Decon Stretcher _____	79	Miller Body Splint _____	81	Water Rescue Equipment _____	96 - 117
Descenders, Escape _____	19	Mini-Haul Kit _____	45	Water Rescue Sled _____	110
Descenders, Figure 8 _____	19, 48	Multipod _____	65 - 69	Webbing _____	64
Descenders, Rack-type _____	47	Mustang Survival _____	98, 101, 111	Webbing Ladder _____	64
Dive Mask _____	105	Packs _____	89 - 91	Weight Vest, Manikin _____	86
Drag Hook _____	78	Patient Handling _____	72 - 82	Weight Vest, Personnel _____	88
Dry Suits _____	100, 101	Personal Flotation Devices _____	97, 98	Wetsuits _____	102
Duffle Bags _____	92 - 94	PRIME Rescue Harness _____	23	Winch, Rescue _____	71
Edge Guard _____	8	PROBE™ Search Line _____	6	Winch, Tripod _____	68, 70
Edge Protection _____	8	Prusik Cord _____	4	Wristlet _____	26
Edge Roller _____	8	Prusik, Sewn _____	5		
E-FLARE™ _____	129	Pulleys, Aluminum _____	37 - 41		
EGRESS™ Escape Rope _____	7	Pulleys, Knot Passing _____	41		
Equipment Packs _____	89, 90, 91	Pulleys, PMP _____	37 - 39		
Escape / Search Bag _____	15	Pulleys, Stainless Steel _____	39, 40		
Escape Belt _____	20	Pulleys, Swivel _____	42		
Escape Anchors _____	19	Quadlock Carabiner _____	33		
Escape Kits _____	16 - 18	Radio Harness _____	133		
Etrier _____	64	Raft Kit _____	108		
EXTRACTOR™ CSR Kits _____	57	RAMFAN™ _____	135		
Fall Protection Devices _____	68	Reeves Sleeve _____	81		
Fall Protection Harness _____	25	Rescue 8 Descender _____	48		
Fins _____	107	Rescue Cradle _____	29		
Firefighters' Rescue Slings/ Kits _____	22	Rigging Hardware _____	49, 50		
Fire Resistant Manikin _____	84	Rigging Plate _____	49		
Flexible Stretcher _____	75, 81, 82	Rigging Slings _____	58 - 60		
Gibbs Ascender _____	44	RIT Drag Bags _____	12		
Gloves, Dive _____	104	RIT Kits _____	12 - 18		
Gloves, Rescue/Rappel _____	126	River Board _____	110		
Harness, Belt _____	20, 21	Rock Exotica _____	42		
Harness, Chest _____	28	Rope & Equipment Bags _____	11		
Harness, Confined Space _____	23, 25	Rope Accessories _____	9, 10		
Harness, Escape _____	20, 21	Rope Pad _____	8		
Harness, Fire Resistant _____	20, 21	Rope, ACCESS™ Lifeline _____	2, 3		
Harness, Rescue _____	23 - 29	Rope, Dynamic _____	3		
Harness, Riggers _____	25	Rope, Fire Resistant _____	6, 7		

## PRODUCTS BY SECTION

Rope _____	1	Manikins _____	83
Bags and packs _____	11	Equipment bags/packs _____	89
Fire rescue _____	16	Water rescue _____	96
Harnesses _____	23	Cold weather _____	114
Hardware _____	31	Protective wear _____	121
Rescue kits _____	51	Training _____	118
Slings and lanyards _____	58	Field operations _____	130
Arachnipod _____	65		
Patient transport _____	72		





RescueTECH marks a milestone anniversary this year! We are celebrating 30 years of providing equipment to technical rescuers worldwide. From our humble beginnings in a 500 square foot warehouse space to our current facility that measures almost 19,000 square feet, we strive to provide top quality service and products.

Our production processes have grown to include manufacturing custom padding for our new rescue harnesses such as our **VANGUARD II, ADVANTAGE, AND PRIME** full body harnesses. The process created pads that give the best comfort and support to rescuers. Additionally, hardware collaboration with ISC has created the new D2 Escape Descender and D4 Rescuer Belay Descender. We look forward to serving you for all your equipment needs.

Stay Safe,

**Glenn Newell**

President



# NEW PRODUCTS

NEW & IMPROVED AT RESCUETECH



Sewn Prusik Loop	5
PROBE FR1 Searchline	6
<b>D2 Escape Kit</b>	<b>16</b>
EGRESS Extension Sling	18
D2 Escape Descender	19



Aztek 4:1 Edge Management Set	42
ISC RED Back-Up Device	43
Foot Ascender	45
Rocker	45
D4 Belay Descender	46
Rescue 9 Descender	48



<b>VANGUARD II Full Body Harness</b>	<b>23</b>
PRIME Fire/Rescue Harness	23
ADVANTAGE Full Body Harness	24
EXPERT II Speed Full Body Harness	24
Adjustable Spreader Plate	26
Harness Ascender Loop	26



Quik-Rig HD	58
Quik-Pik Strap	60
Technician Tripod	70
Clik-Lok Stokes Lashing Set	74
Stretcher Harness Set	77

<b>VANGUARD II Seat Harness</b>	<b>27</b>
Adjustable TAC Harness	27
Clik-Lok Chest Harness	28
NFPA Large D Aluminum, Autolock	33
LUKE Oval Aluminum Carabiner	33
Double End Aluminum Single Pulley	38
Omni Block 2.0	42

<b>Firehouse Training Manikin</b>	<b>84</b>
ShoutBox Extrication Manikin	84
ShoutBox GP Manikin	84
Dive Rescue/Recovery Manikin	85
Manikin Drag Protector	87
Deluxe SCBA Mask Bag	95

Long Tow Tether, Autolock	99
Mustang Water Rescue Drysuit	101
Havoc Water Rescue Helmet	105
ACR C-Strobe	106
Oceanid Swiftwater Rescue Boat	109



<b>PIXA 2 / PIXA 3 Headlamp</b>	<b>124</b>
TORRENT LED Hand Light	129
SHOCKWAVE LED Dive Light	129
DELSAR USAR Search Kit	131
Harness Radio Holster	133
Con-Space Hasty Search Kit	134

251 Beulah Church Rd.  
Carrollton, Georgia 30117

800.334.3368  
770.832.1672 FAX  
www.rescueTECH1.com

# RESCUETECH ACCESS LIFELINE™ STRIPES



	Diameter		Color / Stripe	NFPA Tensile Strength*		WLL**	NFPA Rating	Wgt. / 100 ft
5157xxxOR	7/16"	11 mm	Orange w/ Yellow	7,330 lbf.	32.6 kN	525 lbs.	Technical	5.4 lbs.
5157xxxBL			Blue w/ Yellow					
5157xxxLG			Lime Green w/ Blue					
5157xxxRD			Red w/ Yellow					
5157xxxYE			Yellow w/ Blue					
5147xxxWB			White w/ Red					
5147xxxWR			White w/ Blue					
5158xxxOR	1/2"	13 mm	Orange w/ Yellow	9,960 lbf.	44.3 kN	667 lbs.	General	7.0 lbs.
5158xxxBL			Blue w/ Yellow					
5158xxxLG			Lime Green w/ Blue					
5158xxxRD			Red w/ Yellow					
5158xxxYE			Yellow w/ Blue					
5148xxxWR			White w/ Red					
5148xxxWB			White w/ Blue					
5159xxxOR	5/8"	14.5 mm	Orange w/ Yellow	10,207 lbf.	45.4 kN	760 lbs.	General	12.2 lbs.
5159xxxBL			Blue w/ Yellow					
5159xxxRD			Red w/ Yellow					
5159xxxYE			Yellow w/ Blue					

\*Calculated as 3 standard deviations from the average tensile strength.

\*\* WLL - Recommended Working Load (also known as Safe Working Load) is calculated using the NFPA 15:1 Safe Working Load Ratio.

#### 7/16" Color w/ Stripe

5157150xx	7/16" x 150'
5157200xx	7/16" x 200'
5157300xx	7/16" x 300'
5157600xx	7/16" x 600'

#### 7/16" White w/ Stripe

5147150xx	7/16" x 150'
5147200xx	7/16" x 200'
5147300xx	7/16" x 300'
5147600xx	7/16" x 600'

#### 1/2" Color w/ Stripe

5158150xx	1/2" x 150'
5158200xx	1/2" x 200'
5158300xx	1/2" x 300'
5158600xx	1/2" x 600'

#### 1/2" White w/ Stripe

5148150xx	1/2" x 150'
5148200xx	1/2" x 200'
5148300xx	1/2" x 300'
5148600xx	1/2" x 600'

#### 5/8" Color w/ Stripe

5159300xx	5/8" x 300'
5159600xx	5/8" x 600'

## TECHNOTE

### Number of Sheath Strands

The number of sheath strands affect the performance of a kernmantle rope. Fewer strands equate to a thicker sheath and can give a greater resistance to abrasion; but make the rope feel rough and may cause sheath slippage. More strands give the rope a smoother "feel". But, more strands mean a thinner sheath and may make the rope stiff; affecting the knot-tying performance. RescueTECH's kernmantle ropes take all factors of sheath design into consideration to give each type of rope, static or dynamic, the best of all handling characteristics.

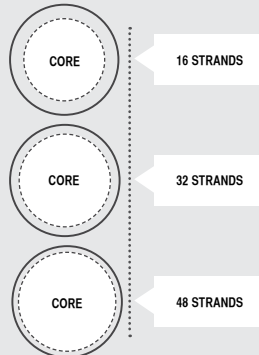

### STRIPES vs SOLIDS

Different colors are very useful in distinguishing particular ropes during a rescue or training operation. The addition of stripes to ropes offers the rescuer the ability to see the movement of the rope. When two striped ropes are used side-by-side, the stripes act as index marks. If the stripes on the two ropes are not moving in relationship to each other, then the ropes are travelling at the same speed.

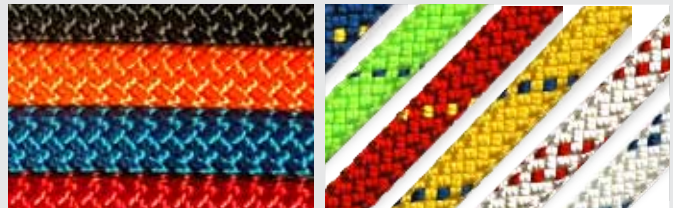



# RESCUETECH ACCESS LIFELINE™ SOLIDS

RescueTECH spent 35 years helping design some of the best known rescue ropes in the world. Now, we have used our knowledge to create a rope design that gives the best combination of all desired characteristics. By building the ropes from the “ground up”, we are able to provide a super-strong rope with low stretch and excellent flexibility and knotability. By using a combination of a 32 strand polyester sheath and nylon core, our ropes actually handle better after 6 months of use than some new ropes from other manufacturers. We specifically address the issue of sheath slippage when constructing all of our top quality Rescue Ropes. Solution dyed color insures that colors won't run. All ropes of the same diameter will perform identically, making multi-rope systems much easier to control. Certified to NFPA 1983 and EN1891. Available in 11 color combinations.



	Diameter		Color	NFPA Tensile Strength*		WLL**	NFPA Rating	Wgt. / 100ft
<b>5156xxxORS</b>	3/8"	9.5 mm	Orange	6,070 lbf.	27 kN	405 lbs.	Technical	4.7 lbs.
<b>5156xxxBLS</b>			Blue					
<b>5156xxxRDS</b>			Red					
<b>5156xxxBKS</b>			Black					
<b>5157xxxORS</b>	7/16"	11 mm	Orange	7,870 lbf.	35 kN	525 lbs.	Technical	5.4 lbs.
<b>5157xxxBLS</b>			Blue					
<b>5157xxxRDS</b>			Red					
<b>5157xxxYES</b>			Yellow					
<b>5157xxxBKS</b>			Black					
<b>5157xxxODS</b>			Olive Green					
<b>5158xxxORS</b>	1/2"	13 mm	Orange	10,000 lbf.	46 kN	667 lbs.	General	7.0 lbs.
<b>5158xxxBLS</b>			Blue					
<b>5158xxxRDS</b>			Red					
<b>5158xxxYES</b>			Yellow					
<b>5158xxxBKS</b>			Black					
<b>5158xxxODS</b>			Olive Green					

3/8" Solid Color	
<b>5156300xxx</b>	3/8" x 300'
<b>5156600xxx</b>	3/8" x 600'
7/16" Solid Color	
<b>5157150xxx</b>	7/16" x 150'
<b>5157200xxx</b>	7/16" x 200'
<b>5157300xxx</b>	7/16" x 300'
<b>5157600xxx</b>	7/16" x 600'
1/2" Solid Color	
<b>5158150xxx</b>	1/2" x 150'
<b>5158200xxx</b>	1/2" x 200'
<b>5157300xxx</b>	1/2" x 300'
<b>5157600xxx</b>	1/2" x 600'



## DYNAMIC ROPE

### Highest Quality / Load Absorption

A dynamic rescue rope manufactured for special applications when climbing above the rigging point. Superior construction with the highest quality standards. High fall rating, low impact loads, increased resistance to abrasion. Special “DRY” water resistant coating helps keep this rope from absorbing water. Exceeds current UIAA and CE standards for dynamic ropes.

**Strength:** 5,500 lbf.  
EN 892.

		Diameter	Length	UIAA Tested As	Weight / meter	UIAA Falls Survived	Max Impact Load	80 kg Elong
<b>5952165AM</b>	Amber Mix	11mm	165 ft.	Single	75.2 gm	14	9.62 kN	4.8
<b>5952165BL</b>	Blue Mix	11mm	165 ft.	Single	75.2 gm	14	9.62 kN	4.8

## TECHNOTE

### Prusik Cord vs. Accessory Cord

What is the difference between prusik cord and accessory cord? Generally, there is no difference. The key is to provide a cord that has specifications and characteristics that meet the needs of rescuers. Prusik cords work because of their flexibility that allows the initial engagement of the prusik hitch. Additionally, the diameter difference between the main line and the prusik cord is an essential element in the overall holding strength of the hitch.

### Rope End Termination

We developed our rope end terminations after many years of research and development. Our first “knotless termination was a proprietary swaging method. Our process pressed the entire length of the aluminum ferrule rather than multiple 5/16” rings along its length. The swaged termination grips the rope along the whole length of the swage to give excellent holding power and increase the user's ability to inspect the rope. In response to requests to develop a end loop without the aluminum swages, RescueTECH developed a sewn-eye termination process. We are able to provide end terminations that exceed current NFPA strength requirements for rope-end terminations. The new Sewn-Eye ropes are lighter and more streamlined than the older Swaging process. All of our EXTRACTOR CSR™ Rescue Kits include the new sewn-eye ropes.

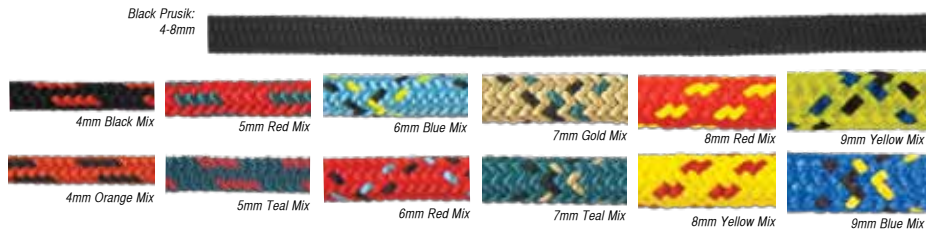

## RESCUETECH PRUSIK CORDS

Prusik cords with the same high quality and long wear design as our Rescue Ropes. Size selection should be based upon diameter of main line.

Available by the foot or in Spool

Lengths: 4mm / 5mm / 6mm x 300 ft.  
7mm / 8mm / 9mm x 200 ft.



	Diameter	Strength	Colors	Main Line
5094000	4 mm	720 lbf.	Black Mix, Orange Mix	5/16 - 3/8"
5095000	5 mm	1,200 lbf.	Black, Teal Mix, Red Mix	3/8"
5096000	6 mm	1,650 lbf.	Black, Blue Mix, Red Mix	7/16 - 1/2"
5097000	7 mm	2,300 lbf.	Black, Teal Mix, Gold Mix	1/2 - 5/8"
5098000	8 mm	2,900 lbf.	Black, Red Mix, Yellow Mix	1/2 - 5/8"
5099000	9 mm	3,670 lbf.	Blue Mix, Yellow Mix	5/8"

## 5MM TECH CORD

Tech Cord's small diameter and 5,000 pound strength are a result of using a unidirectional core of 100% Technora fibers and a tightly woven polyester sheath. Tech Cord is extremely strong and lightweight.

Colors: Green Mix, Blue Mix, Solid Black **Strength:** 5,000 lbf.

	Length
23910500	Tech Cord x ft.
23910550	Tech Cord x 50 ft.
239105660	Tech Cord x 660 ft.



# WATER RESCUE ROPES



## PRO-POLY™ WATER RESCUE ROPE

100% Polypropylene  
Kernmantle construction.  
Smooth sheath construction.  
Used in our Water Rescue Throwbags. Floats on top of water. Not recommended for rappelling or other heavy uses.

Color: Yellow w/ Red & Blue Stripes

## 7/16" WATER RESCUE ROPE

Nylon / Polypropylene  
A special hybrid filament water rescue rope. Manufactured with a durable nylon sheath and a Multi-Filament Polypropylene core, this floating rope has a tensile strength of 5,000 lbf.

Color: Yellow w/ Red Stripes and Yellow w/ Blue Stripes

## 3/8" STANDARD POLY THROWLINE

100% Polypropylene  
A throwline that gives rescuers an economic choice from the high-tech lines. Soft and easy to stuff and throw. 100% polypropylene solid braid.

## 8MM NFPA THROWLINE

Polypropylene / Dyneema  
UL Certified to NFPA 1983. Double braid construction of high strength core fibers covered in polypropylene to create a floating rope that meets the required strength specifications.

Color: Bright Yellow w/ Red Stripes

	Diameter	Strength	Rating
A. 516600	Pro-Poly	3/8"	2,960 lbf. Throwline
B. 516700	Pro-Poly	1/2"	3,400 lbf. Throwline
C. 50517000YR	Water Rescue	7/16"	5,000 lbf. Throwline
D. 50517000YB	Water Rescue	7/16"	5,000 lbf. Throwline
E. 50528000	NFPA Throw	5/16"	4,300 lbf. Throwline
F. 230327000	Standard	3/8"	1,900 lbf.



Sling

Loop

### PRUSIK SLINGS

		Length	Color
751180182	Prusik Sling, Short	18"	Yellow
751180202	Prusik Sling, Short	20"	Yellow
751180284	Prusik Sling, Long	28"	Red
751180304	Prusik Sling, Long	30"	Red

### PRUSIK LOOPS

		Length	Color
751280182	Prusik Loop, Short	18"	Yellow
751280202	Prusik Loop, Short	20"	Yellow
751280284	Prusik Loop, Long	28"	Red
751280304	Prusik Loop, Long	30"	Red

### RESCUETECH SEWN PRUSIKS

Our Product Development Department has worked hard to provide a durable sewn 8mm prusik for use in rescue systems. Two styles are available: Prusik Slings and Prusik Loops. Prusik Slings form 2 loops – one that will cinch down onto the carabiner. The Prusik Loops are sewn as a continuous loop. Our heavy duty stitching uses thread that is 150% thicker/stronger than other brands. Since not all PMPs are equally sized, we have created 2 sizes of Short Prusiks to work with the Long Prusiks. The stitches are covered with a transparent shrink tubing. Testing shows that a single RescueTECH Sewn Prusik pulled on RescueTECH's ACCESS 1/2" Lifeline starts "clutching/slipping" at a strength of 3,000 lbf\*. When pulled end-to-end the single loop strength exceeds 4,500 lbs. Marked with durable labeling to help product identification.

#### Best Fit Sizing:

- For pulleys with sideplates up to 5" use the 18" and 28" Set
- For Pulleys with sideplates up to 6.75" use the 20" and 30" set

\* Results may vary depending upon brand and condition/age of the main rope.

## WARNING

Technical rescue and safety is potentially hazardous. Any person using equipment sold by RESCUE TECHNOLOGY in any manner is personally responsible for learning the proper techniques involved, and assumes all risks and accepts full and complete responsibility for any and all damages or injury of any kind, including death, which may result from the use of any RESCUE TECHNOLOGY equipment.



7/16" sewn eye

### SEWN EYE LIFELINES

Available in 7/16" or 1/2"

RescueTECH's newest addition to our industrial lifelines. Lighter weight than swaged eyes, these lifelines provide strengths that meet NFPA and federal standards. Each lifeline is labeled with a unique production lot number. Made to order in our factory with quick turnaround.

Use only with rope grabs designed for kernmantle rope and that match the diameter of the rope selected.

	Rope Diameter	Length	Color	Tensile Strength
	7/16"	150'		6,300 lbf. 25 kN
598751150xx			Blue, Orange, Red	
598751150xx			White w/ Blue, White w/ Red	
	7/16"	200'		6,300 lbf. 25 kN
598751200xx			Blue, Orange, Red	
598751200xx			White w/ Blue, White w/ Red	

	Rope Diameter	Length	Color	Tensile Strength
	1/2"	150'		9,400 lbf. 41.8 kN
598851150xx			Blue w/ Yellow, Orange w/ Yellow, Red w/ Yellow	
598851150xx			White w/ Red, White w/ Blue	
	1/2"	200'		9,400 lbf. 41.8 kN
598851200xx			Blue w/ Yellow, Orange w/ Yellow, Red w/ Yellow	
598851200xx			White w/ Red, White w/ Blue	

## TECHNOTE

### Working Load Limit (WLL)

Working Load Limit (WLL) (also known as Safe Working Load or Recommended Working Load) is defined as the maximum load that may routinely be applied to an assembly or component in straight tension. Two other strength terms are ultimate strength (or tensile strength) and Minimum Breaking Strength (MBS). Ultimate Strength is the load at which a component or assembly will fail in a test. Minimum Breaking Strength, as defined by NFPA 1983, is the result of subtracting three standard deviations from the mean result of the test lot. We have chosen to use the NFPA ratio of 15:1 for ropes and the American engineering standard of 10:1 for critical use hardware and auxiliary equipment. We realize that these ratios may exceed proposed standards, but have selected them because they best apply to the rescue community. We show the Working Load Limit (WLL) because the ultimate strength may change during the life of the product. Whereas, the WLL will remain valid during the normal life of the product. For example, a 9,000 lbf. rope will lose tensile strength as it is used. However, the WLL will remain 600 lbs. throughout the normal service life of the rope. Additionally, rescue products should be chosen and matched based upon their WLL. The item with the lowest WLL limits the system working load limit. Remember, a chain is only as strong as its weakest link.



### UTILITY / HOISTING LINE

100% Multifilament polypropylene for a myriad of utility use. Ideal for hoisting equipment. Soft, supple, easy to grip.

Strength: 4,000 lbf. WLL: 400 lbs.

Diameter: 5/8" Color: Black  
NOT FOR LIFE SAFETY USE.

	Length
230319001	Hoisting Line x ft.
230319051	Hoisting Line x 50'
230319101	Hoisting Line x 100'
230319601	Hoisting Line x 600'





### PROBE-REFLECTIVE SEARCH LINE W/ SNAP

*Reflective Stripe for Greater Visibility*

Patterned after a major N.E. city's version, the RescueTECH Search Rope w/ Snap combine our PROBE-R Technora / Polyester Reflective Search Rope w/ our Double Locking Escape Snap and Swivel Trigger Snap. Durable I.D. labels are sealed under heat shrink tubing.

	Length	Weight
299722200	200'	3.6 lbs.
299722100	100'	2.4 lbs.
299722050	50'	1.2 lbs.



### PROBE-REFLECTIVE™ FR SEARCH LINE - REFLECTIVE

*Fire Resistant with Reflective Stripe*

Constructed using the same materials as the standard PROBE™ Search Line with the addition of a 3M Scotchlite® retro-reflective stripe. Precut lengths are finished with a special sealant to prevent unravelling.

**Strength:** 2,400 lbf.

52716000R	PROBE-R™ x ft.
52716035R	PROBE-R™ x 35'
52716050R	PROBE-R™ x 50'
52716100R	PROBE-R™ x 100'



### PROBE™ FR SEARCH LINE

*Fire / Heat Resistant Sheath*

6mm diameter Search Line with sheath made from Fire Resistant Aramid fiber for extreme durability and resistance to heat (900° F). Firm, yet flexible, design is superior to "Hollow or Flat" braid construction. Maintains cross-section so cord can be easily felt on the floor. Precut lengths are finished with a special sealant to prevent unravelling.

**Strength:** 2,400 lbf.

52716000	PROBE™ x ft.
52716035	PROBE™ x 35'
52716050	PROBE™ x 50'
52716100	PROBE™ x 100'



### PROBE-HYBRID™ SEARCH LINE

*Aramid / Polyester Hybrid*

*Pattern may differ slightly from image.*

PROBE- Hybrid rope uses both Fire Resistant Aramid Fibers and Polyester to create a highly visible and economical search rope. All of the cord's strength is derived from the Aramid Fiber. The bright Lime Green polyester fibers act as a heat indicator. At 350°F the polyester fibers melt leaving the load bearing aramid in place for safety backup. Precut lengths are finished with a special sealant to prevent unravelling.

**Strength:** 2,000 lbf.

		Length
52736000	PROBE-Hybrid™	x ft.
52736035	PROBE-Hybrid™	35'
52736050	PROBE-Hybrid™	50'
52736100	PROBE-Hybrid™	100'



### PROBE FR1 SEARCH LINE

Designed to provide a high-strength, low-profile search line that will fit into smaller packages. The PROBE FR1 is a hollow braid 8mm searchline made from 100% Technora with yellow and orange markers.

**Strength:** 3950 lbf. (17.6 kN) **Diameter:** 8mm

		Length
54165000	Probe FR1	x ft.
54165035	Probe FR1	35'
54165050	Probe FR1	50'
54165100	Probe FR1	100'
54165200	Probe FR1	200'





### EGRESS™ PERSONAL ESCAPE ROPE

100% Technora Sheath with Nylon Core

A new Fire Resistant Personal Escape Rope (P.E.R.) from RescueTECH™. We redesigned our original Escapeline to provide lighter weight and greater versatility. This tough 7.5mm rope has a strength of 5,200 lbf. Perfect for your high temperature escape line needs. Precut lengths are finished with a special sealant to prevent unravelling.

		Length
52618000	EGRESS™ P.E.R.	x ft.
52618050	EGRESS™ P.E.R.	50'
52618070	EGRESS™ P.E.R.	70'
52618100	EGRESS™ P.E.R.	100'

Warning: Small diameter cords do not provide the same amount of rappelling friction as do larger ropes. Rescuers should practice rappelling with an 8mm cord to become familiar with the 8mm diameter lines. NFPA 1983 states that Personal Escape Ropes are for single use only.



### EGRESS+PLUS™ PERSONAL ESCAPE ROPE

100% Technora Fire Resistant

RescueTECH's superstrong, 100% Technora construction provides both sheath and core resistance to fire and heat.

Diameter: 7.5mm Heat Resistance: > 900° Strength: 4,000 lbf.

		Length
52628000	EGRESS+Plus™ P.E.R.	x ft.
52628050	EGRESS+Plus™ P.E.R.	50'
52628070	EGRESS+Plus™ P.E.R.	70'
52628100	EGRESS+Plus™ P.E.R.	100'

Precut lengths are finished with a special sealant to prevent unravelling.



### EGRESS-N™ PERSONAL ESCAPE ROPE

EGRESS-N gives firefighters an economic alternative to high priced aramid ropes. The 8.5mm EGRESS-N is certified to NFPA 1983 as a Personal Escape Rope.

Strength: 4,026 lbf.

		Length	Color
52818000	EGRESS-N™ P.E.R.	x ft.	White/Blue
52818050	EGRESS-N™ P.E.R.	50'	White/Blue
52818070	EGRESS-N™ P.E.R.	70'	White/Blue
52818100	EGRESS-N™ P.E.R.	100'	White/Blue

		Length	Color
52828000	EGRESS-N™ P.E.R.	x ft.	Yellow/White
52828050	EGRESS-N™ P.E.R.	50'	Yellow/White
52828070	EGRESS-N™ P.E.R.	70'	Yellow/White
52828100	EGRESS-N™ P.E.R.	100'	Yellow/White



### EGRESS-HYBRID™ PERSONAL ESCAPE ROPE

New Aramid / Polyester Technology

The 7.5mm EGRESS-Hybrid™ rope is a blend of aramid and polyester fibers. The tough, fire-resistant aramid fibers in the sheath give the rope its strength and durability. While the polyester fibers lighten the weight and provide greater visibility. The end result is a strong, heat resistant cord that is lighter in weight and more economical than PER made from 100% aramid fibers.

Strength: 4,000 lbf.

		Length
52617000	EGRESS-Hybrid™ P.E.R.	x ft.
52617050	EGRESS-Hybrid™ P.E.R.	50'
52617070	EGRESS-Hybrid™ P.E.R.	70'
52617100	EGRESS-Hybrid™ P.E.R.	100'



## RESCUETECH ROPE GUARD

### Super H.D. Cotton Duck Liner

Special protective sleeve made with super heavy cotton canvas. Outside of Rope Guard covered with heavy weight PVC fabric to protect from hazards and to provide distinctive color. Designed to protect ropes from abrasion when stretched across rough surfaces encountered in rappelling, rescue, high rise building maintenance, and other operations. Webbing loops are attached at each end to provide tie-backs to secure rope guard.

**Color:** Black, Red

	Size	Length
612412x	Small	12"
612418x	Medium	18"
612424x	Large	24"
612436x	XLarge	26"

Substitute "x" with Color Code: (1) Black, (4) Red



(Left) Wide Rope Pad (Right) Narrow Rope Pad with Velcro

## RESCUETECH ROPE PAD

### Super-Heavyweight Cotton Duck

Large 100% cotton rope pads are 2 layers thick in the center and use no synthetic material on its protective surface. Narrow pad with velcro will wrap around rope - secures with hook and loop fastener. Wide pad provides large area coverage. Both pads come complete with rigging grommets for tie-back cords.

**Color:** Natural

	Size	Dimensions
612101	Narrow	36" x 12"
612100	Narrow w/ Velcro	36" x 12"
612105	Wide	36" x 30"
612110	Extra-Large	36" x 60"

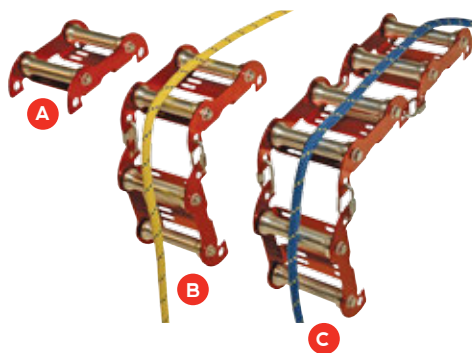

## RESCUETECH MULTI-UNIT EDGE ROLLER

### Rapid Link Connectors

The next generation edge protection device from RescueteCH. Featuring an alloy aluminum frame and rollers, this unit may be used as a single unit or paired-up with other units to provide large area protection using included rapid link. Low Profile design. All units 5.75" wide.

		Units	Length	Weight
A. 611111	Single	1	8.25"	1.6 lbs.
B. 611112	Double	2	17.75"	3.35 lbs.
C. 611113	Triple	3	26.50"	5.1 lbs.
D. 611114	Quad	4	35.25"	6.85 lbs.
60510106	6mm Connector Link			



## RESCUETECH MULTI-UNIT EDGE ROLLER

### Webbing Linkage

Our original M.U.E.R. now links with a length of webbing. Webbing linkage allows the unit to be used to provide large area protection. Units may be linked together. Low Profile design. All units 5.75" wide. Includes 1" H.D. Flat webbing.

		Units
611213	Triple	3
611214	Quad	4



## ROPE ROLLER SET

### 3-side Rope Channel

A new edge roller system to protect ropes from damage when working over sharp edges. The system is fully modular, consisting of edge-roller boxes manufactured from high grade aluminum connected with steel rapid links. Each box has a series of rollers that protect the rope in three directions. Multiple sets can be "chained" to provide a long coverage area.

**Individual Roller dimensions:** 2.4" x 2" x 2"

**Maximum rope diameter:** 1/2" (13mm)

		Length	Weight
201404093	Triple	10.5"	43 oz.
201404094	Quad	15"	59 oz.

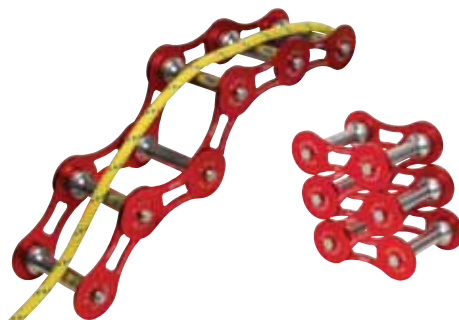

## RESCUETECH ONE PIECE EDGE ROLLER

### Single Unit Edge / Roof Roller

Fully protects rope from corners and other points of friction. Uses aluminum rollers mounted on Oilite® bushings for extended wear. Alloy aluminum construction, steel fittings. Lightweight and low profile. Four connecting points for easy attachment and linking units together. Works best on 90 degree corners like window ledges or parapet walls. Can also be used as small diameter hose roller.

**Tensile Strength:** 10,000 lbf. **Dimensions:** 5" x 9"

**Weight:** 27.2 oz. **Color:** Gold

**Rating:** General Use

Exceeds NFPA 1983/ANSI/OSHA strength specifications.

611101

## ALL TERRAIN EDGE ROLLER

Manufactured with rollers turning on sealed ball bearings for incredibly smooth rope pulls. This low profile unit allows litters to be easily raised over the unit and will provide a smooth pull over various types of edges. The unit can be wrapped around objects and have the ends secured with carabiners. The unit folds up into a 7" cube for easy storage and deployment. The side plates are manufactured from a high strength aluminum alloy.

**Dimensions:** 22.25" x 7" x 2.25" **Weight:** 4.45 lbs.

20021101

All Terrain Edge Roller







### ROPE THIMBLE

Made from an almost indestructible polyolefin polymer that deforms rather than breaks under heavy load. Produces no sharp edges. Rope guards hold the rope in the guide grooves.

Weight: 1 oz.

	Fits rope diameter
5999246	3/8"
5999248	7/16", 1/2"
5999249	5/8"



### ROPE WASHER

Device connects to standard hose for washing or rinsing ropes. Best on light dirt or for rinsing washed ropes.

	Size	Fits rope dia.	Weight
5999203	Standard	up to 1/2"	6.1 oz.
5999204	Large	up to 3/4"	8.8 oz.



### RESCUETECH ROPE CLEANSER

Reformulated to clean ropes better. Excellent for nylon, polyester, or polypropylene fibers. Excellent cleanser for Harnesses, Slings, and other webbing / fabric products. Concentrated formula can be diluted to suit the dirt or stain encountered. Biodegradable.

	Size	Weight
599911	Pint	1.1 lbs.
599910	Concentrate for Gallon	4.4 lbs.



### MESH WASH SACK

Great for rope washing, packaging slings, webbing, cords, and personal gear.

	Size	Dimensions	Weight
805401	L	30" x 15"	3.2 oz.
805406	XL	36" x 24"	5.6 oz.

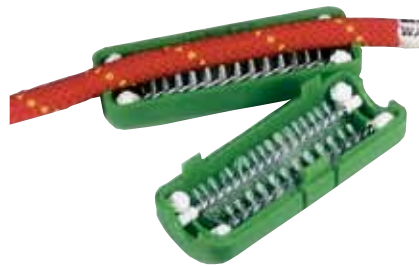

### DOBI ROPE BRUSH

Rope washing the easy way. Just put the rope inside the rope washer, add mild soap and water, and work the Dobi back and forth along the rope. The revolving bristles help to gently remove grime, dirt, and metal oxides from rope. Fits 3/8" - 1/2" ropes.

Weight: 3.2 oz.

5999211	Dobi Rope Brush
---------	-----------------



### ROPE MEASURER

Accurately measures a wide variety of cordage from 5/32" to 3/4" diameter. Digital counter indicates feet and inches up to 999 feet 11 inches, and continues. Unit will also subtract footage. One knob quickly resets counter. Unit is ready to mount to side of 2 x 4". Also works with webbing up to 1" wide.

Weight: 54 oz.

		Weight
901030	Rope Measurer	61.6 oz.
901035	Wall Mounting Bracket	16.8 oz.
901036	Table Mounting Bracket	3.2 oz.

## TECHNOTE

### Please Remember....

A life is much more valuable than a piece of rope. So replace your rope if there is any doubt as to its condition. It is very important to practice these guidelines on the use and care of your rope. Improper care and use of your rope could result in a serious injury or death.



### ROPE CUTTING BOX

Ideal for cutting and sealing numerous ropes and webbing. Can be mounted to wall or workbench. Capable of cutting ropes up to 1" diameter. 120 volts AC. Blade is designed for longer use than standard blades.

Weight: 44 oz.

901020	Cutting Box
901025	Replacement Blade Box



### DOUBLE END ROPE BAG

Made from Cordura™ Nylon w/ grab and throw loops. Drawstring openings at both ends allow user to "rotate" the rope using both ends equally. Manufactured in U.S.A.

Color: Black

	Size	
804201	Small	150' of 1/2"
804301	Medium	200' of 1/2"
804401	Large	300' of 1/2"



# BAGS & PACKS

We take pride in our bags and packs. Made in our factory in Carrollton, Georgia, you are assured of top quality products that will exceed your expectations. Our bags feature no exposed fabric edges that can unravel, reinforced and taped load-bearing seams, and designs that are function driven. Over the years, we have upgraded our shop to include programmable sewing machines, heat presses, and embroidery machines that let us make bags that are rescue-purpose built.



- Ergonomic Padded Shoulder Straps
- Molded Rubber Carry Handle

## REFLECTIVE PVC ROPE BAG



Shoulder Straps and Molded handle

As durable as it is visible at night. Manufactured of 14 oz. nylon reinforced PVC fabric and an 18 oz. nylon reinforced PVC Fabric bottom.

**Dimensions:** Small: 18" H x 10" D Medium: 20" H x 10" D  
Large: 18" H x 12" D

	Size	
802204	Small	200 ft. of 1/2"
802304	Medium	300 ft. of 1/2"
802404	Large	500 ft. of 1/2"



## RESCUETECH ROPE BAGS

*Super-Durable Construction*

Constructed of heavy duty water resistant Cordura™ nylon and nearly-indestructible Ballistic Nylon fabrics. Side seams of bags are double-stitched so that no fabric edges are exposed for fraying. Bottom seam is double stitched and webbing reinforced for superior strength and resistance to abrasion. Drawstring closure with cord lock. Accommodates rope (capacities listed) or equipment. All units except personal size have log book pouches and grommets in bottom to permit drainage. Handles connected to interior of bag.

• Double Stitched and Taped Bottom Seam • Double Stitched • Side Seam • Tough 1000 Denier Cordura® Body  
Durable Ballistic Fabric Bottom • No Exposed Fabric Edge to Unravel • Drainage Grommet in Bottom • Heavy Duty Cord-Lock Adjusts Drawstring • Interior Log Pouch



		Capacity			Dimensions Open	Handles	Shoulder Straps	Colors
		7/16"	1/2"	5/8"				
80111x	Personal	45'			10" x 6"	2	n/a	OR, BK, BL
80121x	Small	175'	125'	75'	12" x 10"	2	n/a	OR, BK, BL, RD, YE, GR
80131x	Medium	300'	225'	125'	20" x 10"	2	1	OR, BK, BL, RD, YE, GR
80141x	Large	400'	325'	200'	26" x 10"	2	2	OR, BK, BL, RD, YE
80151x	XLarge	600'	400'	250'	20" x 14"	2	2	OR, BK, BL, RD
80161x	Super	750'	600'	325'	26" x 14"	2	2	OR, BK, BL
80171x	Jumbo	1150'	900'	500'	26" x 17"	2	2	OR, BK

Replace X: 0= Orange; 1=Black; 2=Yellow; 4=Red; 5=Green; 6=Blue.



## ROPE AND EQUIPMENT BAGS

*With Attached Equipment Pockets and Padded Shoulder Straps*

Constructed of heavy duty water resistant Cordura™ nylon and nearly-indestructible Ballistic Nylon fabrics. Side seams of bags are double-stitched so that no fabric edges are exposed for fraying. Bottom seam is double stitched and webbing reinforced for superior strength and resistance to abrasion. Drawstring closure with cord lock. Accommodates rope (capacities listed) or equipment. Handles connected to interior of bag.

**Rope capacity:**

**Medium:** 20"h x 10"d fits 7/16"- 300 ft. or 1/2"- 225 ft.

**Large:** 25"h x 10"d fits 7/16"- 400 ft. or 1/2"- 325 ft.

	Size	Color
807434	Medium w/ 1 Pocket	Red
807436	Medium w/ 1 Pocket	Blue
807431	Medium w/ 1 Pocket	Black
807444	Large w/ 2 Pockets	Red
807446	Large w/ 2 Pockets	Blue
807441	Large w/ 2 Pockets	Black



(Above)

**A.** Shoulder Strap made from Rescue-Grade Heavy Duty Kevlar web, steel adjuster, and aluminum carabiners (included). Can convert to 26" long loop, 52" long single point sling, or can be detached and used as a downed firefighter rescue sling.

**B.** One Large External Gusseted Tool Pouch has two full-length compartments to hold buddy air hose and breaching tools. Special pass-through slot is ideal for pre-rigged buddy or quick-fill airlines. Also shown is the optional Embroidered "RIT" Label.

**C.** Bag Made from RescueTECH's proprietary Fire Resistant Fabric.

**D.** High Temperature Retro-Reflective Strips

## RIT\*2 EMERGENCY SCBA PACK

### Fire Resistant Multi-Use RIT Packs

The RIT\*2 Emergency SCBA Pack is the logical evolution of our popular Deluxe SCBA Pack. The outside shell is manufactured from RescueTECH's proprietary fire-resistant fabric. Comprised of 6 compartments, this pack will hold what your team needs for Rapid Intervention operations. Main Compartment designed for a full SCBA Backpack. Search line pouch holds 200 ft. of 8mm Searchline. Mask pouch and long pocket have hose "pass-through" to the padded main compartment. One 20" and two 10" side compartments holds tools and individual search line bags. Pack features included L.E.D. Strobe for extra visibility. Easily replaceable Skid Plate extends life of the bag. Custom labelling available.

**Dimensions:** 32" L x 12" W x 12" D **Weight:** 7.7 lbs.



1. Mask Pouch fits masks with extra-long air hose. Pass-through slot to the main compartment allows pre-rigging of airlines and rescue without opening main compartment. 2. Drag Handles on Both Ends are easy to use with Structural Gloves. 3. Zippered Searchline Pouch for Easy Stowing of up to 200 ft of 8mm PROBE™ Searchline. 4. We originated the Skid Plate for RIT Bags in 2003 and still make the best. Our Skid Plate is heavy duty 1/8" Haircell Polyethylene to increase durability. We take the time to pre-contour the Skid Plate to allow the bag to ride up and over obstacles. The extra width helps prevent bag roll-over. 5. Two Small External Gusseted Tool Pouches hold extra search equipment.

Equipment not included.

299625104	RIT*2 Pack
80899501	RIT Label
299625104S	RIT*2 Skid Plate, Replacement

## DELUXE RIT EMERGENCY SCBA PACK

Includes 2 Full-Length Exterior Tool Pouches and Skid Plate

The Deluxe RIT Emergency SCBA Pack is the next generation in multi-use RIT Packs. Comprised of 5 compartments, this pack will hold what your team needs for RIT operations. Main Compartment designed for a full SCBA Backpack. Search line pouch holds 200 ft. of 8mm Searchline. Mask pouch has a regulator hose "pass-through" to the padded main compartment. 20" side compartments hold tools and individual search line bags. Pack features included L.E.D. Strobe for extra visibility. Replaceable Skid plate extends life of the bag. Made from high strength coated nylon fabric.

**Dimensions:** 32"L x 12"W x 12" D

Equipment not included.



**A.** Mask Pouch w/ Drag Handle **B.** High Temperature Retro-Reflective Stripes. **C.** Zippered Searchline Pouch for Easy Stowing **D.** Two 22" External Gusseted Tool Pouches. **E.** Heavy Duty 1/8" Haircell Polyethylene Skid Plate for Extra Wear Protection.

299625103	Deluxe RIT Pack
299625103S	Skid Plate, Replacement

## WARNING

Technical rescue and safety is potentially hazardous. Any person using equipment sold by RESCUE TECHNOLOGY in any manner is personally responsible for learning the proper techniques involved, and assumes all risks and accepts full and complete responsibility for any and all damages or injury of any kind, including death, which may result from the use of any RESCUE TECHNOLOGY equipment.



PROBE™ Search Line w/ Snap

## PROBE™ SEARCH LINE KITS

### Fire-Resistant Design

6mm cord with fire resistant sheath (Temp 900°F). 6mm cord can be felt on ground unlike units made with flat webbing. Bags are specially designed for easy deployment with structural gloves. Autolocking Fixed Eye Snap prevents accidental detachment of carabiner from its anchor. Fixed Eye prevents PROBE™ Search line cord from becoming detached from carabiner. Search Bag manufactured with RescueTECH's proprietary fire resistant fabric. Retro-reflective tape increases visibility of bag. Notice: PROBE™ search cord is not NFPA Personal Escape Line and cannot be used for a Personal Escape rope.

	Length
29985035	35'
29985050	50'
29985100	100'



## PROBE-R™ SEARCH LINE KITS

### Fire-Resistant with Reflective Stripe

The same high quality materials and design as our original PROBE™ Search Line with 3M Scotchlite® added to the sheath. Provides extra visibility of Search Lines during fire operations. Search Bag manufactured with RescueTECH's proprietary fire resistant fabric. Notice: PROBE-R™ search cord is not NFPA Personal Escape Line and cannot be used for a Personal Escape rope.

PROBE-Reflective™ FR Search Line - Reflective p.#

	Length
29985035R	35'
29985050R	50'
29985100R	100'



PROBE-Hybrid Kit shown with Snap deployed and ready to use

PROBE-Hybrid™ Search Line

## PROBE-HYBRID™ KITS

### New Hybrid 6mm Searchline Cord

Assembled with a new hybrid 6mm cord. The cord's sheath is manufactured using both fire resistant aramid fibers (Temp 900°F) for fire resistance and polyester for lighter weight. The 6mm round cord can be felt on ground unlike units made with flat webbing. Bags are manufactured of RescueTECH's proprietary fire resistant fabric, hook and loop fastener, nylon webbing and features Scotchlite® retro-reflective striping. Bag is specially designed for easy deployment with structural firefighting gloves. Autolocking Fixed Eye Snap prevents accidental detachment of carabiner from its anchor. Fixed Eye prevents Searchline cord from becoming detached from carabiner. Retro-reflective tape increases visibility of bag. Notice: PROBE-Hybrid™ search cord is not NFPA Personal Escape Line and cannot be used for a Personal Escape Rope.

	Length
29985035H	35'
29985050H	50'
29985100H	100'



100 ft. model shown

## BASIC SEARCH KITS

### Now Available with Captive Eye Carabiner

A basic Search Kit featuring our 7mm Nylon SearchLine cord. These kits offer a protective search line at an economical price. Cord is stored in our durable Escape / Search Bags made from Cordura and Ballistic Fabrics. Autolocking Aluminum Search Snap at end of cord can be clipped to rigging point or back onto search line. Bag attaches to waist belt of SCBA or Rescue harness or worn on shoulder with attached strap. Kit includes Bag, Cord, and Carabiner. Notice: PROBE-Nylon™ search cord is not NFPA Personal Escape Line and cannot be used for a Personal Escape rope.

	Length
299813035	35'
299813050	50'
299813100	100'



## PROBE FR1 SEARCH KIT

The PROBE FR1 Search Kit combines our top quality search pouches with our new 8mm PROBE-FR1 Search Line. 8mm PROBE-FR1 is a high-strength, low-profile line that will fit into smaller packages. Search Bag manufactured with RescueTECH's proprietary fire resistant fabric.

29986035	35'
29986050	50'
29986100	100'



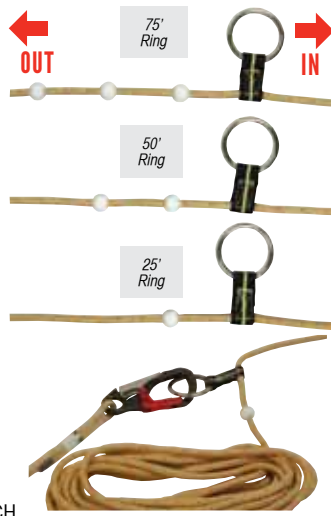

Individual Search Lines attach to rings



## MARKER™ SEARCH ROPE KIT

Complete with 2" Rings and Directional Marking

At the request of a major Texas city, RescueTECH designed a special "Master" pack for their RIT teams. Durability and quality are prime considerations with this pack. Durable Cordura Nylon fabric with removeable, quick-release shoulder strap. The pack also features "daisy chain" web loops on the shoulder strap and reverse side of pack. The kit has 200 feet of our 7.5mm RescueTECH EGRESS-Hybrid™ or EGRESS+Plus™ search rope complete with 2" rings every 25 ft. The Rope is also marked with 3/4" nylon balls to indicate distance and direction (ex. 3 balls = 75 ft.). Using the phrase "Ring, then Bump = Out to the Pump", a firefighter can identify direction and distance to the exit. Kit includes 200 ft. with Autolocking snap sewn to each end and a Searchline Shoulder bag with quick release seatbelt buckles. 200 ft. Marker™ rope is also available as a separate item.

299823200	Marker-H™ Search Rope Kit, 200'
299723200	Marker-H™ Search Rope Only, 200'

299824200	Marker+PLUS Search Rope Kit, 200'
299724200	Marker+PLUS Search Rope Only, 200'



## ATX GROUP SEARCH KIT™

Our ATX Group Search Kit was designed for a major TX city to fulfill their Large Area Search needs. The Kit is set up for a four person RIT team and provides a means of marking location and a guideline to the outside. Comprised of one Marker Search Rope Kit (see above) and individual search line kits with fire resistant bag. The Marker Search Rope has nylon balls affixed to the rope to mark distance - no knots to slip or snag. The individual search kits are equipped with an autolocking, strength-rated aluminum hook that is fixed to the end of the rope without knots. Search kits can clip to webbing loops on master kit and can either be hung from belt or SCBA frame or can be slid onto waist belt. Search kits feature quick-disconnect strap if threaded on waist belt. Available in 4 and 5 person kits in either 35 ft. or 50 ft. Search kits.

		Length
29982016135	4 person Kit - 1 master / 3 Search	35'
29982016235	5 Person Kit - 1 master / 4 Search	35'
29982016150	4 person Kit - 1 master / 3 Search	50'
29982016250	5 Person Kit - 1 master / 4 Search	50'



SearchLine Master Pack™ shown with two (2) 100 ft. Master Lines and six (6) 35 ft. Search Lines

## SEARCHLINE MASTER PACK™

4/6/8 Person RIT Search Line Set



A Searchline Set ready to deploy for Rapid Intervention. The Master Pack consists of a high quality carrying bag made from 1000 den cordura, Ballistic Cloth, and closed cell foam. Zippered inside pouches can hold items up to 18" in length. Extra room in main compartment can hold tools up to 22" long. The pack contains two (2) 100 foot master deployment lines and six (6) search lines (select 35 ft. or 50 ft. models.) Available with PROBE™ Fire Resistant Aramid Search Line or PROBE-R™ Fire Resistant Search Lines w/ Reflective Stripe.

Dimensions: 23"L x 12"W x 8"D

		Length
29982006135	Probe™	35'
29982006150	Probe™	50'
29982006235	Probe™ - Reflective™	35'
29982006250	Probe™ - Reflective™	50'
29961800	Master Pack, Carrying Bag Only	



## ATX MASTER SEARCH PACK

The pack we designed for our Marker Search Rope Kit and ATX Group Search Kit is now available as a separate item. Durable Cordura Nylon fabric with removeable, quick-release shoulder strap. Features "daisy chain" web loops on the shoulder strap and reverse side of pack. Holds up to 200' of 7.5mm cord.

	Color
800120041	Black
800120042	Yellow



# RESCUETECH ESCAPE/SEARCH BAGS

RescueTECH designed our Escape / Search bag to be multi-functional. The Velcro closure secures the content against accidental deployment. The bags are constructed to allow users to clip them to a harness or airpack using the steel "D" rings or thread it onto a waist strap. A quick-release function will detach the bag from a waist belt with a simple pull of the release tab. Fire Resistant retro-reflective stripes increase user visibility. Available in Fire Resistant (red) or Nylon (orange) fabrics.



Quick-Release  
Belt Snap System

Front equipment  
pouch separates  
hooks and snaps  
from rope.



## NYLON ESCAPE / SEARCH BAG



Lined, 2-Layer construction for extra strength and durability. All seams double stitched for extra durability.

**Color:** Orange

Equipment not included.

	Size	Fits Length	Closed Dimensions
8001310	XS	25' Escape Rope	5" x 6" x 3"
8001320	S	35' Escape Rope	6" x 6" x 3"
8001330	M	50' Escape Rope	7" x 6" x 3"
8001340	L	70' Escape Rope	9" x 6" x 5"

## FIRE-RESISTANT ESCAPE / SEARCH BAG



*Fire Resistant Outer Shell*

A new design for drop bags featuring a lined, 2-layer construction that protects cord while easing access with structural gloves. Attaches to harness waist belts. All seams double stitched for extra durability.

**Color:** Red

Equipment not included.

	Size	Fits Length	Closed Dimensions
8001414	XS	25' Escape Rope	5" x 6" x 3"
8001424	S	35' Escape Rope	6" x 6" x 3"
8001434	M	50' Escape Rope	7" x 6" x 3"
8001444	L	70' Escape Rope	9" x 6" x 5"



## NYLON DROP BAG



*Durable 1000 denier Construction*

Designed to hold our 8mm EGRESS™ Personal Escape Rope and PROBE™ Search Line kits, this Drop Bag is perfect to "create-your-own" rescue kit. Hinged Lid with snap closure. Retro-reflective tab makes this bag highly visible and easy to open with structural firefighting gloves. Attaches to Escape Belt and Harnesses.

**Color:** Red

Equipment not included.

	Size	Fits Length	Closed Dimensions
800520	S	35' of 8mm Cord	9" x 6" x 3"
800521	M	70' of 8mm Cord	10" x 7" x 4"
800522	L	100' of 8mm Cord	12" x 7" x 5"



## RESCUETECH SEARCHLINE SHOULDER BAG

*Holds 200 ft. of 6mm search cord*

A new "Over-the-Shoulder" bag that easily holds up to 200 ft. of PROBE™ Search Line. Manufactured of tough Ballistic Nylon to a major Texas city's specification. Inside strap system pre-tensions the cord for an even deployment. Adjustable shoulder strap may be worn on one shoulder or across the body.

**Dimensions:** 11" x 9" x 5" **Weight:** 4.9 lbs.

800121 Searchline Shoulder Bag



## WARNING

Technical rescue and safety is potentially hazardous. Any person using equipment sold by RESCUE TECHNOLOGY in any manner is personally responsible for learning the proper techniques involved, and assumes all risks and accepts full and complete responsibility for any and all damages or injury of any kind, including death, which may result from the use of any RESCUE TECHNOLOGY equipment.

# EGRESS FIRE RESCUE KITS WITH D2 ESCAPE DESCENDER

NEW!

1



## D2 Escape Descender

The Escape kits on this page utilize the all new D2 Escape Descender. The D2 Escape Descender is the latest in the joint development program between RescueTECH and ISC. Double Stop design for extra safety. Easily positioned on the rope. A simple push on the lever controls descent and lowering functions. No "handle squeeze" required. *(more info on page 19)*



**D2/EGRESS+PLUS - HOOK**  
EGRESS+Plus™ w/ Sewn Eye & Hook

- D2 Escape Descender • Fire Resistant Pouch
- EGRESS+PLUS Rope with FDNY Hook • Extension Strap

		Length
5254011050	D2/ EGRESS+Plus™ Hook	50'
5254011070	D2/EGRESS+Plus™ Hook	70'



**D2/EGRESS+PLUS - SNAP**  
EGRESS+Plus™ w/ Sewn Eye & Snap

- D2 Escape Descender • Fire Resistant Pouch
- EGRESS+PLUS Rope with Autolocking Snap • Extension Strap

		Length
5254012050	D2/EGRESS+Plus™ Snap	50'
5254012070	D2/EGRESS+Plus™ Snap	70'

## 2 SELECT ROPE



Egress-Plus      Egress      Egress-Hybrid

### Personal Escape Rope (P.E.R.)

Select one of our excellent Escape Ropes. These ropes are designed for strength and durability. Choose the

- EGRESS+PLUS (100% Technora Sheath and Core)
- EGRESS (Technora Sheath / Nylon Core)
- EGRESS-Hybrid (Technora/Polyester sheath and Nylon core).

*(more info on page 7)*



**D2/EGRESS - HOOK**  
EGRESS™ w/ Sewn Eye & Hook

- D2 Escape Descender • Fire Resistant Pouch
- EGRESS Rope with FDNY Hook • Extension Strap

		Length
5254111050	D2/EGRESS™ Hook	50'
5254111070	D2/EGRESS™ Hook	70'



**D2/EGRESS - SNAP**  
EGRESS™ w/ Sewn Eye & Snap

- D2 Escape Descender • Fire Resistant Pouch
- EGRESS Rope with Autolocking Snap • Extension Strap

		Length
5254112050	D2/EGRESS™ Snap	50'
5254112070	D2/EGRESS™ Snap	70'

## 3 SELECT END TERMINATION



### Hook or Snap

Select either the Forged Steel FDNY Crosby Escape Hook or our Forged Autolocking snap for the end termination of the Escape Rope. *(more info on page 19)*



**D2/EGRESS - HYBRID - HOOK**  
EGRESS-Hybrid™ w/ Sewn Eye

- D2 Escape Descender • Fire Resistant Pouch
- EGRESS-Hybrid Rope with FDNY Hook • Extension Strap

		Length
5254211050	D2/EGRESS-Hybrid™ Kit	50'
5254211070	D2/EGRESS-Hybrid™ Kit	70'



**D2/EGRESS - HYBRID - SNAP**  
EGRESS-Hybrid™ w/ Sewn Eye

- D2 Escape Descender • Fire Resistant Pouch
- EGRESS-Hybrid Rope with Autolocking Snap • Extension Strap

		Length
5254212050	D2/EGRESS-Hybrid™ Kit	50'
5254212070	D2/EGRESS-Hybrid™ Kit	70'

# EGRESS FIRE RESCUE KITS WITH RT ESCAPE DESCENDER



## RT ESCAPE/EGRESS+PLUS - HOOK

EGRESS+Plus™ w/ Sewn Eye & Hook

- RT Escape Descender • Fire Resistant Pouch
- EGRESS+PLUS Rope with FDNY Hook
- Autolocking Carabiner

		Length
5253011050	RT Escape/EGRESS+Plus™ Hook	50'
5253011070	RT Escape/EGRESS+Plus™ Hook	70'



## RT ESCAPE/EGRESS+PLUS - SNAP

EGRESS+Plus™ w/ Sewn Eye & Snap

- RT Escape Descender • Fire Resistant Pouch
- EGRESS+PLUS Rope with Autolocking Snap
- Autolocking Carabiner

		Length
5253012050	RT Escape/EGRESS+Plus™ Snap	50'
5253012070	RT Escape/EGRESS+Plus™ Snap	70'



1

### RT Escape Descender

The Escape kits on this page utilize our original RT Escape Descender. The RT Escape Descender is a multi-hole descending device that may be rigged to accommodate users weight. Easily positioned on the rope. *(more info on page 19)*



## RT ESCAPE/EGRESS - HOOK

EGRESS™ w/ Sewn Eye & Hook

- RT Escape Descender • Fire Resistant Pouch
- EGRESS Rope with FDNY Hook • Autolocking Carabiner

		Length
5253111050	RT Escape/EGRESS™ Hook	50'
5253111070	RT Escape/EGRESS™ Hook	70'



## RT ESCAPE/EGRESS - SNAP

EGRESS™ w/ Sewn Eye & Snap

- RT Escape Descender • Fire Resistant Pouch
- EGRESS Rope with Autolocking Snap
- Autolocking Carabiner

		Length
5253112050	RT Escape/EGRESS™ Snap	50'
5253112070	RT Escape/EGRESS™ Snap	70'

2

## SELECT ROPE



Egress-Plus

Egress

Egress-Hybrid

Personal Escape Rope (P.E.R.)

Select one of our excellent Escape Ropes. These ropes are designed for strength and durability. Choose the

- EGRESS+PLUS (100% Technora Sheath and Core)
- EGRESS (Technora Sheath / Nylon Core)
- EGRESS-Hybrid (Technora/Polyester sheath and Nylon core).

*(more info on page 7)*

3

## SELECT END TERMINATION



Hook or Snap

Select either the Forged Steel FDNY Crosby Escape Hook or our Forged Autolocking snap for the end termination of the Escape Rope.

*(more info on page 19)*



## RT ESCAPE/EGRESS-HYBRID - HOOK

EGRESS-Hybrid™ w/ Sewn Eye

- RT Escape Descender • Fire Resistant Pouch
- EGRESS-Hybrid Rope with FDNY Hook
- Autolocking Carabiner

		Length
5253211050	RT ESCAPE/EGRESS-Hybrid Hook	50'
5253211070	RT ESCAPE/EGRESS-Hybrid Hook	70'



## RT ESCAPE/EGRESS-HYBRID - SNAP

EGRESS-Hybrid™ w/ Sewn Eye

- RT Escape Descender • Fire Resistant Pouch
- EGRESS-Hybrid Rope with Autolocking Snap
- Autolocking Carabiner

		Length
5253212050	RT ESCAPE/EGRESS-Hybrid Snap	50'
5253212070	RT ESCAPE/EGRESS-Hybrid Snap	70'



25', 35' & 50' Kit



70' & 100' Kit

## EGRESS-N™ ESCAPE KITS

A non-aramid version of our popular EGRESS Kits. Assembled using our EGRESS-N Nylon/Polyester™ NFPA Personal Escape Rope, Nylon Escape pouch, AutoLocking Rigging Carabiners, and RescueTECH ESCAPE 8 Descender. To use, simply open outer pouch, grasp the AutoLocking Rigging Carabiner, and pull from bag. The 8mm EGRESS-N™ Personal Escape Rope (NFPA) makes this PER an economical choice over the fire-resistant EGRESS™. Manufactured of Nylon and Polyester, this certified cord works well with most Escape Descenders. Custom lengths available.

**Strength:** 5,000 lbf.

### Includes:

• EGRESS-N™ P.E.R. • Mini Rescue 8 Descender • NFPA Offset Carabiners • RescueTECH Escape Snap 1000 den Cordura Pouch

Warning: EGRESS-Nylon is not fire or heat-proof. Polyester begins to lose strength at 300 °F. Small diameter cords do not provide the same amount of rappelling friction as do larger ropes. Rescuers should practice rappelling with an 8mm cord to become familiar with the 8mm diameter lines. NFPA 1983 states that Personal Escape Ropes are for single use only.

		Length	Color
5253328050	EGRESS-N™	50'	White/Blue
5253328070	EGRESS-N™	70'	White/Blue
5253328100	EGRESS-N™	100'	White/Blue

		Length	Color
5253428050	EGRESS-N™	50'	Yellow/White
5253428070	EGRESS-N™	70'	Yellow/White
5253428100	EGRESS-N™	100'	Yellow/White



## FIRE RESISTANT TRUCK LANYARD



For use in high abrasion and high heat conditions. Ideal for use on Ladder and Platform trucks. The exceptional heat resistance of Dupont Brand Kevlar® will help those in high heat jobs such as welding, brazing, foundry, etc.

**Length:** 6 ft. **Weight:** 54.4 oz.

753786F Kevlar® Lanyard w/ Zorber & Ladder Hook



## TRUCKMAN'S TOOL HOLSTER



*Fits Most Harnesses*

New design tool / axe holster for rescue harnesses. Fits onto any webbing up to 1.75 inches with heavy duty hook and loop fastener system. Adjustable webbing strap holds tool in place. Fits axes, Halligan tool, etc.

6091514 Tool Holster



## EGRESS EXTENSION SLING

A handy sling for use with Escape Belts and Harnesses. Extends escape descender allowing better handling and visualization of the descender. Made with Kevlar Brand Fire Resistant webbing and thread. We utilize our AutoLocking Escape Snap that is easier to open with structural gloves than twistlock-style carabiner gates. 6mm Stainless Steel Rapid Link provides a secure attachment to escape units.

**Length:** 16"

609005 EGRESS Extension Sling



## WARNING

Technical rescue and safety is potentially hazardous. Any person using equipment sold by RESCUE TECHNOLOGY in any manner is personally responsible for learning the proper techniques involved, and assumes all risks and accepts full and complete responsibility for any and all damages or injury of any kind, including death, which may result from the use of any RESCUE TECHNOLOGY equipment.





### RESCUETECH ESCAPE 8



A compact Escape descender with ears for quick personal escapes. Rescue "ears" are situated to provide a compact Rescue 8 design for escape systems.

**Dimensions:** 2 7/8" x 2 3/4" **Strength:** 3,150 lbf.

**WLL:** 300 lbs. **Weight:** 4 oz.

**Rating:** General Use.

Meets NFPA 1983/ANSI construction specifications for Descenders.

	Color
6010064	Red
6010061	Black



RT Escape Descender shown in one of many friction settings.

### ESCAPE DESCENDER



Special descender plate with multiple holes that allow a small diameter escape cord to be rigged to accommodate different amounts of friction. ALWAYS test your personal rigging method to assure sufficient friction for a safe descent. Works with 8mm to 11mm diameter escape lines.

**Dimensions:** 4" x 2.75"

**Tensile Strength:** 5,000 lbf.

**Weight:** 3.2 oz. **Rating:** General Use.

Meets NFPA 1983/ANSI construction specifications for Descenders.

601005	Escape Descender
--------	------------------

# D2 ESCAPE DESCENDER



201404024 D2 Escape Descender

Our newest Escape Descender for our EGRESS escape ropes. Allows for quick deployment and adjustment before the bail out. Rotating Handle provides exception control. Double Stop for safety. The D2 is a true panic stop device rather than a panic brake device. The difference is that once the panic brake is activated, no other force must be applied to the device. A panic brake style device requires a force input to continue the braking function. Also works well as an emergency lowering device.

**Dimensions:** 5.7" x 2.85"

**Rope Diameters:** 7 – 8mm

**Load Range:** 100 – 300 lbs.



## WARNING

All escape descenders should be fully tested to determine compatibility with the brand of rope used. All users of Escape descenders must be fully instructed in the use of the descenders to ensure competency in "bail-out" and "escape" operations.



### AUTOLOCKING ALUMINUM SNAP HOOK

The Autolocking Aluminum Snap Hook was selected by RescueTECH for use in our EGRESS Escape Kits and PROBE Searchline kits because of its ease of use and dependability. Manufactured of forged aluminum, the autolocking gate is easy to open with structural firefighting gloves. New frame design incorporates feature that protects locking mechanism.

**Colors:** Grey/Red (shown), Black

**Dimensions:** 5.5" x 2.75" (137.5 x 68.8mm)

**Strength:** 6,070 lbf. (27 kN) **Weight:** 4 oz. (108 gm)

**Gate Opening:** .88" (22 mm)

		Color
20149014	AutoLock Snap Hook	Grey/Red
20149011	AutoLock Snap Hook	Black



### CROSBY ESCAPE HOOK

Certified to NFPA 1983

The escape hook is to be used as an anchor in an engineered system for firefighter escape applications or as a component of a system specifically designed by a qualified person for firefighter escape. The user must be trained in the proper usage of the system. The saddle of the hook is designed to easily fit around pipes or framework, and the machined tip is rated for full Working Load Limit. Meets the requirement of NFPA 1983 -Light-Use Auxiliary Equipment. Designed in conjunction with FDNY Research Division.

**Dimensions:** 6.74" x 3.658" **Width of Opening:** 2.14 in.

**Weight:** 13.6 oz.

**DISCLAIMER:** Firefighter escape requires instruction and training. Firefighting and associated operations are dangerous and may cause injury or death. It is every firefighters responsibility to be trained and knowledgeable on their equipment and its intended use.

2416104	Escape Hook
---------	-------------



### WINDOW RAPPEL ANCHOR

Skedco's unique anchor design allows escape from burning buildings where there are no other anchors available. This is your "Last Chance Bailout" anchor. It will fold to be carried in a holster or bailout kit. When used, the ends are extended, a carabiner is placed into the holes in both parts and the anchor is placed into the lower corner of a window and a rope is attached. It is necessary to keep tension on your rope to prevent the anchor from slipping out of position. This anchor keeps your rope farther away from the flames which gives you a little more time to descend to safety. Made in USA.

**Deployed measurements:** 10 5/8" x 3" x 5/8"

**MBS:** 5,000 lbs

**Color:** Red, Black

**DISCLAIMER:** Firefighter escape requires instruction and training. Firefighting and associated operations are dangerous and may cause injury or death. It is every firefighters responsibility to be trained and knowledgeable on their equipment and its intended use.

	Color
21177654	Red
21177651	Black

# FIRE RESCUE

## BELTS, LANYARDS, AND HARDWARE

RescueTECH has spent many years supplying specialized belts and lanyards for a variety of Escape and "Bail-Out" uses. From original Survival Belt first manufactured in 1983 to our Turnout Escape Harness, we spend the time to select the proper webbing and hardware for each item. Our Escape Belts and Harnesses are available in both Fire Resistant Kevlar brand webbing and high strength nylon. And since these items are made in our facility in Carrollton, GA, you are assured of top quality and workmanship.



### CORONA FR TRUCK / ESCAPE BELT

Made from Kevlar Brand Fire Resistant Web

Belt is easily secured around waist using unique double locking snap hook and 'D' Ring adjuster. Can be used as an equipment belt for carrying axes or forcible entry tools. Two light weight D-rings slide along belt to secure escape rope system bag. Retro-reflective striping.

**Strength:** 6,000 lbs. **Weight:** 38.4 oz.

**Waist:** 34 - 56"

Meets structural test requirements of NFPA Life Safety Escape Belt Standard. Meets ANSI/OSHA Class I Belt design requirements.

701132 Fire Resistant w/ Scotchlite®

### CORONA™ FR TRUCK / ESCAPE BELT WITH LADDER HOOK

Made from Kevlar Brand Fire Resistant Web

Our popular Fire Resistant Corona Escape Belt with integral Ladder Hook. Manufactured of Kevlar® Brand fibers from Dupont and forged hardware Retro-reflective striping. One-Size-Fits Most. Ladder Hook manufactured from high strength, alloy aluminum. Perfect for use in ladders and platforms.

**Strength:** 6,000 lbs. **Hook Strength:** 5,000 lbs.

**Weight:** 53.6 oz.

Meets structural test requirements of NFPA Life Safety Escape Belt Standard.

Meets ANSI/OSHA Class I Belt design requirements.

701132H Fire Resistant w/ Ladder Hook



### CORONA™ TRUCK / ESCAPE BELT



This Nylon Escape Belt is the perfect economical substitution for our Kevlar Belt. Belt is easily secured around waist using unique double locking snap hook and 'D' Ring adjuster. Can be used as an equipment belt for carrying axes or forcible entry tools. Two light weight D-rings slide along belt to secure escape rope system. Retro-reflective striping on Gold unit.

**Strength:** 6,000 lbs. **Weight:** 33.6 oz.

**Waist:** 34 - 56"

Meets structural test requirements of Life Safety Escape Belt Standard. Meets ANSI/OSHA Class I Belt design requirements.

Color

701032 Gold w/ Scotchlite®

701031 Black

## WARNING

Technical rescue and safety is potentially hazardous. Any person using equipment sold by RESCUE TECHNOLOGY in any manner is personally responsible for learning the proper techniques involved, and assumes all risks and accepts full and complete responsibility for any and all damages or injury of any kind, including death, which may result from the use of any RESCUE TECHNOLOGY equipment.



### FIRE-RESISTANT TRUCK / ESCAPE BELT

Unique fire resistant "belt" to meet NFPA Ladder / Escape Belt standards. Belt is easily secured around waist using unique double locking snap hook and 'D' Ring adjuster. Can be used as an equipment belt for carrying axes or forcible entry tools. Two light weight D-rings slide along belt to secure escape rope system bag.

**Color:** Black **Weight:** 28.8 oz.

Meets structural test requirements of Life Safety Escape Belt Standard. Meets ANSI/OSHA Class I Belt design requirements.

	Size	Waist
701131	Standard	34 - 56"
701131XL	XLarge	44 - 68"



## UNIFORM EMERGENCY BELT

### Quick Adjust Buckle

A modified version of our Survival Belt™. Lightweight forged “V” ring is used for carabiner attachment point and is held securely by a velcro loop. Forged Steel Adjuster Buckle insures security without slipping. Extra webbing secured with hook and loop fastener.

**Tensile Strength:** 5,000 lbf. **Color:** Black or Red

**Weight:** 10.4 oz. (Standard)

Meets NFPA 1983 Strength requirements for Escape Belt.

Meets ANSI/OSHA Class I Belt design requirements. NFPA Rating: Escape Belt.

Black	Size	Waist	Red	Size	Waist
703306	Standard	28" - 40"	7033164	Standard	28 - 40"
703308	Large	40" - 55"	7033184	Large	40 - 55"



## SURVIVAL BELT™ II

A multi-purpose belt for emergency rappels, belays, restraint straps, anchor slings, tourniquets, etc., that can be worn as a uniform belt. With carabiner attached to the forged buckle, the belt allows the user to “get out quick”. New design uses high strength Adjustable Rigging Buckle. Hook and Loop neatly secures spare

length. Manufactured with 1 3/4" heavy duty webbing.

**Tensile Strength:** 6,000 lbf. **Color:** Black

**Weight:** 9.6 oz. (Medium)

Meets NFPA 1983 Strength requirements for Escape Belt.

Meets ANSI/OSHA Class I Belt design requirements. NFPA Rating: Escape Belt.

	Size	Waist
703521	Small	25" - 36"
703531	Medium	32" - 42"
703541	Large	36" - 48"
703551	XLarge	40" - 55"



## TURNOUT ESCAPE HARNESS

### NFPA Class II

Designed to be kept with your turnout gear, this harness may be worn on the outside or between the barrier layer and shell layer. Special CliK-Lok buckle and attachment strap allows this harness to be easily donned. Waist buckle requires both triggers to be depressed before disengagement. Extended “D” ring rigging point eases attachment. Sizing should be determined by waist measurement while wearing turnout pants. Optional Harness Keeper Tabs fit standard suspender buttons and keep harness in place.

**Weight:** Nylon - 31.2 oz.; Kevlar: 32.8 oz.

	Item Description/Size	Color	Waist
7021131	Nylon, Std	Black	28" - 44"
7021134	Nylon, Std	Red	28" - 44"
7021151	Nylon, XLarge	Black	38" - 54"
7021154	Nylon, XLarge	Red	38" - 54"
7021161	Nylon, XXLarge	Black	40" - 68"
7021231	Fire Resistant, Std	Black	28" - 44"
7021251	Fire Resistant, XLarge	Black	38" - 54"
7021294	Harness Keeper Tabs, Set of 4		



Deluxe Version: Legs store in pouch until ready to use.



## LADDERMAN'S CLASS II HARNESS

### Fire Resistant, Convertible Belt / Harness

A new concept in Ladder Harnesses. Fire resistant Kevlar® webbing provides extra security in high temperature and abrasive environments. Double locking, quick-attach snap at waist allows harness to be easily donned while in turnout gear. Leg straps are conveniently stowed in Nomex pouches until needed and can be donned by simply connecting quick attach snaps. When combined with our Rigger Ladder Hook Extension, the Ladderman's Harness is the perfect combination for safety on ladders and towers. Includes mesh storage bag.

**Proof Load:** 5,000 lbs. **Design Load:** 600 lbs.

**Weight:** 42.4 oz.

Meets structural test requirements of Life Safety Harness Standard. Meets ANSI/OSHA requirements.

701230	Ladderman's Harness
--------	---------------------



CliK-Lok Waist Buckle is connected before closing the pants waist buckle.



“D” Ring rigging point extends up and over waist of pants.



Harness keeper tab snaps around waist belt of harness.



Harness keeper tab attaches to suspender button underneath suspender.



RescueTECH Spin-Lock  
1-way pulley

Auto-Locking  
Carabiners



### FIREFIGHTER LADDER RESCUE SYSTEM

Containing the RescueTECH Spin-Lock Double Pulley, this rescue set provides a free-running 3:1 Block and tackle that does double duty as a friction lowering device. The Spin-Lock Pulley works as a capstain lowering device that provides friction while lowering the firefighter. Proper safety precautions, such as separate brakes or rope grabs are to be used when in both raise and lower modes. Sling attaches around ladder beams or to suitable rigging point above victim. Packaged ready-to-use in RescueTECH Rigging Bucket.



	Height
299845075	2 Story
299845120	3 Story



Stows in Included Pouch

### FIREFIGHTERS DRAG / SEARCH SLING

*Handles with Rubberized Grips*

Designed to aid Firefighters and RIT Team personnel. Stored in an included pouch that will attach to SCBA waist straps or will store in Turnout Gear pockets. The sling is comprised of heavy duty 1" tubular webbing, forged steel D-Ring, non-locking aluminum carabiners, and custom handles with rubberized grips and reflective tape.

**Overall Length of Red Rescue Sling: 70"**

2369104 F.F. Drag/Search Sling

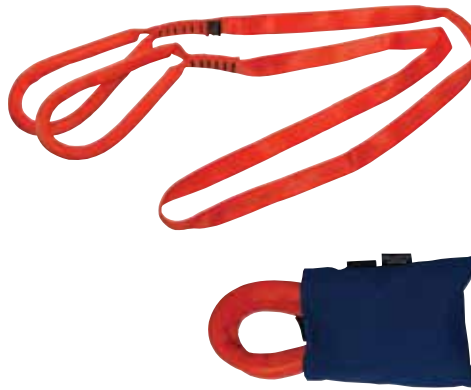

### FIREFIGHTERS' RIT RESCUE SLING

*Multi-Use Rescue Tool*

Designed to be a helping hand during fire rescue activities. Pouch is designed to fit all waist belts and to keep the sling available at all times. Simply grasp the hand loops and pull to deploy this 7 ft. sling. Contoured hand loops are easily grasped by structural firefighting gloves. Multiple uses: RIT, Search, Utility. Can be linked together to help with large area searches.

**Length:** 80" **Weight:** 9.6 oz.

29967420 Rescue Sling

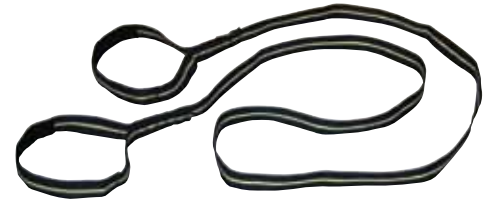

### RIT FR RESCUE SLING

*Fire Resistant Sling and Belt Pouch*

Based on the design of our Firefighters' RIT Rescue sling, the FR Sling is manufactured of Fire Resistant Webbing featuring Kevlar® brand fire resistant fibers. Easily attached Fire Resistant pouch is designed fit all waist belts and to keep the sling available at all times. Simply grasp the hand loops and pull to deploy this 7 ft. sling. Contoured hand loops are held open by an internal stiffener and is easily grasped by structural firefighting gloves. Multiple uses: RIT, Search, Utility. Can be linked together to help with large area searches.

**Weight:** 7.2 oz.

29967521 FR Rescue Sling



### RIT RECOVERY SLING - HOOK

*Recovery Sling w/ Pouch*

We designed this product with RIT Team personnel in mind. The sling is actually two heavy duty slings (joined with high strength industrial snaps) that can be separated and used by one, two, or multiple personnel. The hook may be attached to a turnout coat rescue strap, SCBA strap, or back to the second strap. The sling has an included hook & loop strap that compactly holds the folded unit for storage in the included carrying pouch or turnout pocket.

**Overall Length:** 60" **Weight:** 32 oz.

29967220 RIT Recovery Sling-Hook



# VANGUARD II™ FULL BODY HARNESS



Cert. Model (NFPA 1983.2012)

### NFPA Class III Rescue Technician Harness

We have updated the Vanguard™ harness to feature our new padding design. Built with Aerospacer™ mesh, the padding is hydrophobic / hydrophilic and works as a “pump” that pulls moisture away from the body and helps cool the rescuer. Designed for function and comfort, we have added polycarbonate stiffeners to the waist pad to increase load distribution. Easy donning aided by 2-piece color coded leg buckles. Forged D rings at the front waist and chest provide rescuer main and belay attachments. Forged dorsal ‘D’ ring for fall protection and belay attachments. Lifting rings on shoulders allow vertical lifting out of confined spaces. Canted side ‘D’ rings provide attachment point for positioning lanyards and stow out of the way when not in use. The Vanguard II also allows for both side entry and over the shoulder donning of the chest/shoulder section. Shoulder section attached to seat section with Delta Shaped Rapid Link. Weight: 99.2 oz. Made In U.S.A.

Certified NFPA 1983.

	Size	Height	Waist
7301202	S	5'2" - 6'	27" - 35"
7301302	M/L	5'2" - 6'	31" - 39"
7301502	XL	5'9" - 6'8"	35" - 51"



### PRIME FIRE/RESCUE HARNESS

Our newest harness! A basic design to fit the needs of most rescuers. Quick adjust buckles make sizing easy. Padded Waist and Legs for added comfort. Primary rigging points on the front waist and chest.

	Size	Height	Waist
7321204	S	5'2" - 6'	27" - 35"
7321304	M/L	5'2" - 6'	31" - 39"
7321504	XL	5'9" - 6'8"	35" - 51"

### TECHNOTE



#### Quick Attach Leg Buckles

Many RescueTECH harnesses come with Quick-Attach Adjuster Buckles. These buckles allow the user to don a harness without stepping through a leg loop. With the Quick-Attach buckles, the user simply wraps the loop around their leg, attaches the buckles together, and tightens the webbing. These buckles provide an easy way to put a harness onto a victim.



## WARNING

Technical rescue and safety is potentially hazardous. Any person using equipment sold by RESCUE TECHNOLOGY in any manner is personally responsible for learning the proper techniques involved, and assumes all risks and accepts full and complete responsibility for any and all damages or injury of any kind, including death, which may result from the use of any RESCUE TECHNOLOGY equipment.



**NEW!**

# ADVANTAGE™ FULL BODY HARNESS

### NFPA Class III Work/Rescue Harness.

Our new ADVANTAGE harness utilizes a modified version of our new waist pad design. Incorporating the same Aerospace mesh for comfort, the pad is larger than that of the VANGUARD II and has a polycarbonate stiffener to better distribute the load – increasing the comfortable of the harness. Fully adjustable design features padded waist, legs, and shoulders. Unique shaped shoulder pad system makes the Advantage™ super-comfortable. Suitable for Work and Rescue, Fall Arrest, Work Positioning, Descent, and Ascent. Buckles make size adjustment quick and secure – no need to tie off webbing tails. Main rigging rings at front waist and chest. Fall arrest ring in dorsal position. Stowable side waist rings for positioning. Made In U.S.A.

**Weight:** 88 oz. (Med/Lg)  
**Certified Standards:** • NFPA 1983

	Size	Height	Waist
<b>7311201</b>	Small	5'2" - 6'	27" - 35"
<b>7311301</b>	Medium/Large	5'2" - 6'	31" - 39"
<b>7311501</b>	XLarge	5'9" - 6'8"	35" - 51"



## EXPERT II SPEED

### Technical Rescue Harness

New, fully adjustable Class III harness TUV certified to NFPA 1983. Features padded, waist, legs and shoulders. Unique shaped shoulder pad system makes the Expert II super-comfortable. Suitable for work and rescue, fall arrest, work positioning, descent and ascent. New SPEED buckles make size adjustment quick and secure - no need to tie off webbing tails. Main rigging rings at front waist and chest. Fall arrest ring in dorsal position. Side waist rings for positioning.

**Weight:** 88oz. (Med/Lg)

	Size	Height	Waist
<b>238904524</b>	S	5'2" - 6'	27" - 35"
<b>238904534</b>	M/L	5'2" - 6'8"	30" - 39"
<b>238904554</b>	XL	5'9" - 6'8"	35" - 51"



## ENERGETIC™

### Harness with Integral Sit Board

Full Body harness that meets EN 361 with a load rating of the chest and dorsal attachment point of 15 kN. SPEED buckles ease donning of harness. Positioning D rings divide load to waist belt and to bench. 7.2" wide waist belt made from a combination of foam and high density polyethylene give superior comfort. Two braided gear loops. Reinforced Sit Board. Ideal for all who has to spend a lot of hang time in harnesses.

**Weight:** 116 oz.  
**CE 1019 • EN 813 • EN 358 • EN 361**

	Size	Height	Waist
<b>23890513</b>	M/L	5'2" - 6'8"	31" - 39"
<b>23890515</b>	XL	5'9" - 6'8"	35" - 51"



## TECHNOTE

### Speed Buckles

The new SPEED buckle is a new, quick-connect buckle with side quick release. Made of high strength steel, this buckle is both durable and easy to use. Attachment is a simple as pushing the tab into the mating buckle. 2 finger safety release requires both release tabs to be depressed before the buckle disengages. Integral quick-adjust.







### VOYAGER RESCUE HARNESS

Light weight design provides ease of use. Features quick adjust legs and waist. 5" waist pad for extra comfort. Chest harness attaches to waist with a high strength stainless steel rapid link for corrosion resistance. Quick-adjust leg buckles. No shoulder D-rings on Black version.

**Weight:** 101 oz. (Med.)

UL Certified to NFPA 1983 Class III Harness. Meets ANSI/OSHA Class III Full Body Harness requirements.

	Size	Color		Size	Color
718321	Small	Black	718326	Small	Blue
718331	Medium	Black	718336	Medium	Blue
718341	Large	Black	718346	Large	Blue
718351	XLarge	Black	718356	XLarge	Blue



### TECHNICAL RESCUE II HARNESS

A tuned down super-lightweight version of the popular Voyager harness. Great for entry level technical rescue, rope access, short haul, and basic rope rescue. Features lighter waist and leg pads and no shoulder lifting rings to save weight. Rigging points at waist, chest, and back (dorsal). Rear haul/tag line attachment loop (3600 lbf.). Tailored shoulder straps. UL Classified to NFPA 1983 Meets OSHA/ANSI/CAN/CSA Class III Harness standards.

**Color:** Blue w/ Black pads **Weight:** 68 oz.

UL Certified to NFPA 1983 Class III Harness. Meets ANSI/OSHA Class III Full Body Harness requirements.

	Size
7162136	Small/Medium
7162156	Large/XLarge

### ROPE DANCER™

*Fall Protection Harness*

Easy to don and easy to operate double buckles. Front and rear belay/rappel front attachment points. Reinforced tie-in loop. Full body harness designed specially for rope course.

**Weight:** 47.2 oz.

Meets all ANSI, OSHA standards and CSA construction requirements for Class III Harness.

	Size
23890502	Small
23890503	Medium/Large
23890505	XLarge



### RT INDUSTRIAL 3 'D' FULL BODY HARNESS

*"D" Rings for Lifting / Fall Protection*

Manufactured from color coded 1 3/4" polyester webbing for ease of donning. Forged steel hardware with quick-connect friction buckles for quick secure adjustments. One sliding "D" between the shoulder blades in back for attachment of lanyard and two shoulder lifting rings. Sized to fit over clothing. Positioning version has two rings at waist level. **Weight:** 40.8 oz. Meets all ANSI, OSHA standards and CSA construction requirements for Class III Harness.

	Size
7021334	Medium/Large
7021344	XLarge
7022334	Positioning, Medium/Large
7022344	Positioning, XLarge

### RTR HARNESS

Designed to meet the demands of the transmission line worker, structural access and the rope access professionals. Chest harness designed to incorporate a chest ascender (not included). Attachment points at waist, hips (positioning), chest (positioning), back (lumbar) and back (fall arrest). Extra large, side positioning rings (lineman style).

**Weight:** 6 lb. 11 oz.

Certified to NFPA 1983 standard. Certified to ANSI/OSHA and CAN/CSA full body harness standards.

	Size
204239012	Small
204239013	Medium
204239014	Large
204239015	XLarge



### RESCUETECH ADJUSTABLE SPREADER PLATE

18" Adjustment

The newest addition to our confined space harness lifting equipment is our low-profile Adjustable Spreader Plate. We combine a lightweight aluminum plate with adjustable straps. The adjustment allows the unit to not only work with confined space harnesses, but also with lifting devices such as the LSP Half Back.

Width: 15" Max Height under plate: 21"

Min Height under plate: 8"

609028 RescueTECH Spreader Plate



### RESCUETECH™ HARNESS LIFTING BRIDLE

Double Locking Snaps

Unit attaches to shoulder lifting rings with industrial double locking snaps.

Strength: 6,000 lbf. (26.7 kN) Overall Height: 23" (57.5 cm)

Strap Length: 11" (27.5 cm) Width: 16" (40 cm)

Weight: 38.4 oz. (1.08 kg)

609025 Harness Lift Bridle



### RESCUETECH™ DELUXE HARNESS LIFTING BRIDLE

with Built-In Wristlets

Unit attaches to shoulder lifting rings with aluminum double locking snaps.

Strength: 6,000 lbf. (26.7 kN) Overall Height: 23" (57.5 cm)

Strap Length: 11" (27.5 cm) Width: 16" (40 cm)

Weight: 32 oz. (907 gm)

609026 Deluxe Harness Lift Bridle



### LADDER HOOK EXTENSION™

The Ladder Hook Extension Strap allows the rescuer to attach to a ladder rung. The overall length of 18" provides the perfect length to give the rescuer both comfort and safety. Available with Autolocking Ladder Hook. Forged snap attaches the Ladder Hook Extension to the "D" ring of rescue harnesses.

Strength: 6,000 lbs. (26 kN) Overall Length: 18" (45 cm)

Gate Opening: 1.5" (38mm) NFPA Rating: General Use.

Weight: Steel: 32.8 oz. Aluminum: 25.6 oz.

A. 609012 Alum. AutoLock - Fire Resist.  
B. 609011 Steel AutoLock - Fire Resist.  
C. 609001 Steel AutoLock - Nylon



### WRISTLET

Ergonomic Comfort Pads

Wrist harness for emergency use and for work locations where a full body harness might create a greater risk. Also excellent for situations requiring special positioning of the victim's arms in conjunction with a full body harness. Manufactured from nylon webbing. Special elastic tensioner helps keep unit secure when used as anklet. Comes complete with 2 wristlets and lifting yoke.

Weight: 5.6 oz.

Meets OSHA requirements.

609200 Wristlet



### HARNESS ASCENDER LOOP

This handy, high strength webbing loop enables attachment of a chest ascender to our VANGUARD and ADVANTAGE full body harnesses. Simply girth-hitch the sling around the top "eye" of the chest ascender then pass the loop through the chest "D" ring slot. The loop then attaches to the carabiner or rapid link at the waist of the harness. Ascender not included.

602307 Harness Ascender Loop

NEW!

# VANGUARD II™ PADDED SEAT HARNESS



## VANGUARD™ PADDED SEAT HARNESS

NFPA Class II Rescue Harness.



Cert. Model (NFPA 1983.2012)

Our newest Class II seat harness will impress you with its versatility and comfort. Special “breathable”, laminated foam padding provides comfort not often found in basic seat harnesses. Special 2-piece buckles allow you to don without having to “step-through” the harness. Primary rigging “D” ring floats along the waist strap to better balance the forces placed on the rescue - giving greater comfort. Side “D” rings allow for placement of positioning Lanyards and fold away for storage. Made In U.S.A.

Certified NFPA 1983 Class II Harness

	Size	Waist
7050022	Small	27" - 35"
7050032	Medium	31" - 39"
7050052	XLarge	35" - 51"

CE



## TIMBER™

Full Function Arborist Seat Harness

Adjustable sliding D-ring enables you to take safe, comfortable and effective work position. Wide padding provides superior comfort. Side D-rings for work positioning or gear attachment. 4 gear loops.

Weight: 64.8 oz. (Med/Lg)

	Size	Waist
238900123	Med/Large	30" - 39"
238900125	XLarge	34"- 44"



## ADJUSTABLE TAC SEAT

The Adjustable TAC Seat build from the trusted Adjustable Seat harness design. From this design we created some improvement. Waist and leg buckles are quick-adjust for rapid sizing. Leg loops are designed for maximum comfort and will rotate slightly with leg movement. Forged D ring rigging point.

	Size	Waist
7091031	Med/Large	30" - 39"
7091041	XLarge	34"- 44"



## PADDED ADJUSTABLE TAC SEAT

A padded version of the Adjustable TAC that adds a rear “D” Ring for positioning use.

	Size	Waist
7092031	M/L	30" - 39"
7092051	X/L	34"- 44"





# TECHNOTE

## NFPA Harness Classifications

### Class II

Harness that fastens around the waist and around thighs or under buttocks and is designed for rescue with a design load of 2.67 kN (600 lbf.)

### Class III

Harness that fastens around waist and around thighs or under buttocks, and over shoulders and is designed for rescue with a design load of 2.67 kN (600 lbf.)



### ADJUSTABLE SEAT HARNESS



#### Forged "D" Ring Rigging Point

Double pass waist buckle provides non-slipping adjustment. Double-pass Waist and Quick-adjust leg loops allow the rescuer to don this harness with ease. Forged "D" ring provides a secure attachment point for carabiners. Equipment loops for attaching extra hardware. Used in all types of rappelling and rescue situations. 2 gear loops. Comes with storage bag.

**Weight:** 27 oz. **Color:** Black

Exceeds ASTM/ANSI/OSHA requirements for Seat Harness.

	Size	Waist
7102231	Medium/Large	28" - 40"
7102251	Extra-Large	36" - 54"



### LIGHTWEIGHT TAC RAPPTEL HARNESS



deluxe version

#### Quick Adjust Waist Buckle

The new TAC Rappel Harness features a quick-adjust waist buckle with comfort pads. Additionally, a double thickness waist allows us to put additional gear loops on the right side. Includes storage bag. Available in standard and deluxe version. The Deluxe version utilizes 2-piece leg adjusters that allow the legs to be conveniently stored and the harness used as a belt until the leg loops are needed.

**Color:** Black

Meets NFPA/ASTM/ANSI/OSHA requirements for Seat Harness.



		Size	Waist
7091531	L/W TAC Rappel	M/L	28 - 40"
7091551	L/W TAC Rappel	XL	36 - 54"
7091631	Deluxe L/W TAC Rappel	M/L	28 - 40"
7091651	Deluxe L/W TAC Rappel	XL	36 - 54"



### CLIK-LOK RESCUE CHEST HARNESS

The Clik-Lok Rescue Chest harness provides a full body chest rigging point when attached to our VANGUARD or Adjustable TAC Seat Harnesses. Clik-Lok chest closure makes donning easy. Quick-Adjust chest and shoulder straps. Includes Standard D Steel Autolocking carabiner.

7235134



### STANDARD CHEST HARNESS



#### General Purpose Chest Harness

A basic style chest harness with "V" ring attachment point that can be connected with a carabiner or rope. The Standard Chest Harness features 2" chest strap webbing and 2" shoulder strap webbing. Fully adjustable. One Size Fits Most.

**Color:** Black **Weight:** 15.2 oz.

Exceeds NFPA construction requirements. Meets ANSI Class II Harness construction requirements.

723321	Standard Chest Harness
--------	------------------------



## WARNING

Shoulder straps are not for vertical lifting!



### VICTIM CHEST SLING

Attaches to Ladder / Victim Harness, turning the system into a Class III Victim Harness. Wide, padded chest strap supports victim's upper torso during vertical lifts. Quickly attaches around victims chest. Connects with Double Locking Snap. Padded for comfort. Adjustable Chest and seat connector straps.

**Weight:** 32 oz.

**723201** Victim Chest Sling



Legs store in color-coded pouches and are ready to use.

### VICTIM HARNESS

**Quick-Connect Buckles**

An innovative dual purpose harness, built to NFPA strength standards. Constructed of 1 3/4" high strength webbing, the Ladder/Victim Harness utilizes special forged color-coded quick-connect friction buckles on legs to aid in proper donning. Leg straps are stored in attached pouch to easily store and transport this harness. Special Clik-Lok waist buckle with pad is quick to don and insures user comfort. Clik-Lok version utilizes buckles on waist and legs.

**Color:** Black w/ color-coded leg straps. **Weight:** 30.1 oz. Exceeds NFPA 1983 strength requirements for Class II Harness.

**708366** Victim Harness, Clik-Lok  
**708365** Victim Harness, 2pc Buckle



### DELUXE VICTIM RESCUE CRADLE



Full Upper Body coverage with padded back panel for greater patient comfort and security. 7 strap support for superior strength. Forged D Tag line anchor helps rescuers control patient in vertical environment. Victim Arm Keepers maintain control of upper extremities. 4 Grab handles aid in maneuvering victim before, during, and after the vertical lift. Manufactured of 1000 den fabric with Cordura brand fibers, high strength webbing and forged steel hardware. (Manikin, Carabiner, and Tether not included.) **Weight:** 96 oz.

\*Does not replace proper patient packaging using backboard, cervical collar, and head blocks.

- A. Forged Steel Attachment Points.
- B. Heavy Duty Webbing.
- C. Rolls up for Storage.
- D. Contoured Grab Handles aid Rescuers.
- E. Padded Back Panel with internal polycarbonate support frame.

**708353** Rescue Cradle\*



### MESH EVACUATION TRIANGLE

**Features Adjustable Center Strap**

Full body support for security and comfort. Easily installed on seated or standing persons. Grid design of webbing fully supports patient while mesh provides extra comfort as well as drainage for use in water rescues. Includes adjustable shoulder straps. Constructed of heavy duty Vinyl coated polyester mesh high strength webbing. Forged 'D' ring rigging points. High visibility contrast stripe for day or night use.

**Weight:** 53.6 oz.

\*Does not replace proper patient packaging using backboard, cervical collar, and head blocks.

**708352** Mesh Evacuation Triangle\*



### EVACUATION TRIANGLE

**with Shoulder Straps**

An updated design of our original Evacuation Triangle. We have created a more compact version. Complete with shoulder straps.

**Weight:** 35.2 oz.

\*Does not replace proper patient packaging using backboard, cervical collar, and head blocks.

**708350** Evac Triangle w/ Straps\*



### HARNESSE EQUIPMENT POUCH



Designed to hold the many tools required by rescue technicians. The main pocket has a special collar closure that is secured with a cord lock. The front bellows pouch can hold quickly needed equipment. An exterior gear loop and mesh pocket multiplies the uses of this high quality bag.

**Dimensions:** 8"H x 6.5"W x 4.5"D    **Weight:** 9.6 oz.

Equipment not included.

	Color
800211	Black
800214	Red
800216	Blue



### FRANKLIN WORK BOARD

*Integrates with Most Harnesses*

The Franklin Work Positioning Seat provides more comfort when hanging in the harness and is intended for use with our fall arrest or work positioning harnesses. Easy to adjust buckles. Wide sitting area gives good stability and comfortable hanging as well as standing work position. Suspension straps do not press on your thighs. Three D-rings (bearing capacity 110 lbs.) for gear.

**Max. load of seat:** 500 lbs.    **Weight:** 3.4 lbs.

23898110    Franklin Work Board



*Harness Rigging Pouch shown on Corona™ Escape Belt*

### HARNESSE RIGGING POUCH



A great addition to a rescuer's gear selection. The Rigging Pouch attaches to the waist belt of a rescue harness and provides quick access to often used equipment. Padded sides. Holds carabiners, slings, pulleys, etc. Easy access while "on rope". Locking Zipper prevents accidental opening. Inside features rigging loop and snap closure mesh pouch.

**Dimensions:** 9.5"W x 7"H x 3"D    **Weight:** 8 oz.

**Rating:** General Use.

Equipment not included.

800201    Harness Rigging Pouch



### LAIKA DOG HARNESS

Intended for transport of the dog from a helicopter or other high angle environments. Universal size. Aluminum-alloy adjusters.

**Color:** Orange    **Capacity:** 300 lbs

**Weight:** 24.8 oz.

23898115    Laika Dog Harness



# HARDWARE BY RESCUETECH

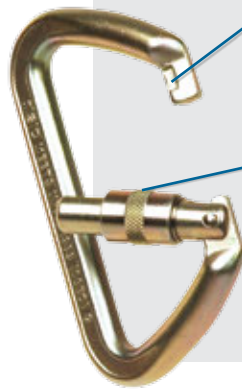

### No-Snag Gate

Starting with our 2010 model RD70™ carabiners, RescueTECH will begin to integrate a no-snag gate/frame design into our rescue carabiners. This special design virtually eliminates the gate from snagging webbing or cordage.

### Side Swing Gate

We helped design the original Angle Gate design with the Rescue D carabiner (1985). This design maximizes gate clearance creating extra room for use of the carabiner with gloves. The angle gate create almost a full 1.5 inches of carabiner opening space. Our RD70 is the first to combine the No-Snag gate with the side swing design – another first for RescueTECH.



### RESCUETECH BIG DAN™

*Designed to Prevent Cross-Loading*

Combines all the ideal design ideas into one carabiner. The Big Dan's unique frame is design to prevent cross-loading the carabiner. Cross-loads are quickly realigned to the major axis. The curved back modified 'D' design optimizes the strength and handling characteristics. Available in Twistlock (2-stage) and Supersafe (3 stage) safety mechanisms.

**Strength:** 11,241 lbf. (50 kN) **WLL:** 1,124 lbs. (511 kg)

**Gate Opening:** 1.0" (25mm)

**Dimensions:** 5.25 x 3.5" (133 x 89mm)

**Weight:** 11.2 oz. (278gm) **NFPA Rating:** General Use  
NFPA 1983, ANSI/OSHA compliant.

6051179S	Supersafe - 3 Stage
6051179T	Twistlock - 2 Stage



### RESCUETECH RD70™ MULTI-STAGE LOCKING GATE

*Autolocking Rescue Carabiners*

The newest version of our popular RD70 Rescue Carabiner. Featuring either the 2-stage Twistlock or 3-Stage Supersafe gate design. Features No-Snag gate design.

**Strength: Gold/Black:** 15,737 lbf (70 kN) **WLL:** 1,574 lbs. (715 kg)

**Stainless Steel:** 11,251 lbf (50 kN) **WLL:** 1,125 lbs. (511 kg)

**Gate Opening:** 1.4" (35mm) **Dimensions:** 4.9 x 2.9" (125 x 73mm)

**Weight:** 10.4 oz. (360 gm) **NFPA Rating:** General Use  
NFPA 1983, ANSI/OSHA compliant

		Color
60511830	Twistlock	Gold
60511840	Supersafe	Gold
60511860	Twistlock	Stainless Steel



### RESCUETECH RD70™ RESCUE CARABINER

*Featuring No-Snag Gate Design*

Rescue Tech's newest general use carabiner. Design to meet the tough-use conditions met by Rescue Technicians. Heat-treated alloy steel construction with Gold Chromate corrosion protection.

**Strength: Gold/Black:** 15,737 lbf (70 kN) **WLL:** 1,574 lbs. (715 kg)

**Stainless Steel:** 11,251 lbf (50 kN) **WLL:** 1,125 lbs. (511 kg)

**Gate Opening:** 1.4" (35mm) **Dimensions:** 4.9 x 2.9" (125 x 73mm)

**Weight:** 9.5 oz. (360 gm) **NFPA Rating:** General Use  
NFPA 1983, ANSI/OSHA compliant

		Color
60511820	Screwgate	Gold
60511821	Screwgate	Black
60511850	Screwgate	Stainless Steel



A



B



C

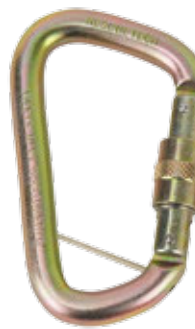

D

### RESCUETECH OD50™ RESCUE CARABINER

*A Great Multi-Use Carabiner*

Heat-treated alloy steel construction with Gold Chromate corrosion protection. Made to meet the toughest rescue needs.

**Strength:** 11,241 lbf. (50 kN) **WLL:** 1,124 lbs. (511 kg)

**Gate Opening:** .8" (20mm) **Dimensions:** 4.4 x 2.7" (111 x 68mm)

**Weight:** 8.8 oz. (220gm) **NFPA Rating:** General Use

NFPA 1983, ANSI/OSHA compliant

		Color
A. 60511750	Screwgate	Gold
B. 60511730	Twistlock	Gold
C. 60511731	Twistlock	Black
D. 60511760	Screwgate w/ bar	Gold
60511740	Twistlock w/ bar	Gold
60511751	Screwgate	Black





### RESCUETECH™ EXTRA-LARGE RESCUE 'D'

Extra Large 1.5" Gate Opening

A new design in rescue carabiners. Extra-large gate and interior dimensions let this carabiner's gate close over any round structure that will fit through the gate. 1/2" alloy steel plated with Gold Chromate. Gate locking design.

**Strength:** 12,589 lbf. (56 kN) **WLL:** 1,259 lbs. (572 kg)

**Gate Opening:** 1.5" (38mm) **Dimensions:** 6 x 3.75"

(152 x 94mm)

**Weight:** 12.8 oz. (363gm) **NFPA Rating:** General Use  
UL Certified NFPA 1983.

Meets ANSI/OSHA strength requirements.

6050159	XL Rescue D	\$35.00
---------	-------------	---------



### STAINLESS STEEL OFFSET 'D'

Proof Tested

Stainless Steel provides excellent corrosion resistance.

**Strength:** 7,870 lbf. (35 kN)

**WLL:** 787 lbs. (358 kg)

**Gate Opening:** .8" (20mm)

**Dimensions:** 4.5 x 2.5" (118 x 64mm)

**Weight:** 8.8 oz. (220gm)

**NFPA Rating:** General Use  
NFPA 1983, ANSI/OSHA compliant

6053120	Twistlock	\$40.00
6053121	Supersafe	\$42.00
6053123	Screwgate	\$37.00



### RESCUETECH STEEL OVAL CARABINER

Manufactured from heat treated alloy steel and plated for corrosion resistance. Available in Screwgate and Twistlock.

**Dimensions:** 4.3" x 2.3" **Gate Opening:** .72"

Certified BS EN 362.

		Strength	Weight
201431120	Screwgate	5,620 lbf. (25 kN)	6.0 oz. (170 gm)
201431130	Twistlock	5,620 lbf. (25 kN)	6.6 oz. (187 gm)



### KLETTERSTEIG STEEL

		Dimensions	Gate	Strength	WLL	Weight
A. 6053170	Twistlock	4.9" x 3.15"	1.0"	10,000 lbf.	1,000 lbs.	8.8 oz.
B. 6053172	Screwgate	4.9" x 3.15"	1.0"	10,000 lbf.	1,000 lbs.	8.8 oz.
6053171	Supersafe	4.7" x 3.15"	1.0"	10,000 lbf.	1,000 lbs.	8.8 oz.

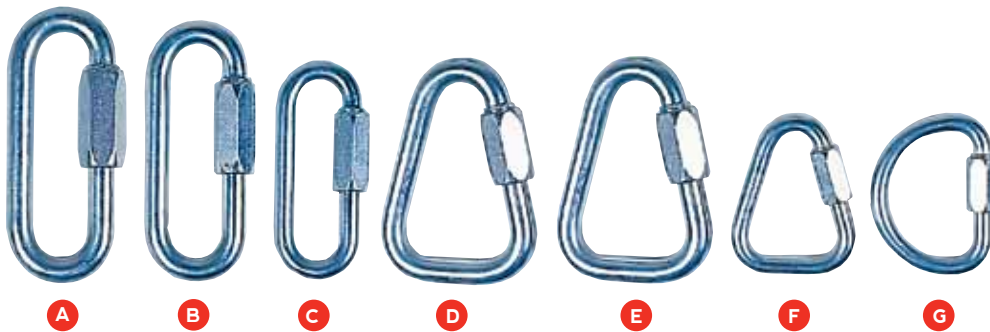

### RAPID LINKS

These links are often an inexpensive alternative to standard carabiners. They are most effective in applications for semi-permanent attachments. The Delta shape link is used where multi-directional loading is encountered. All the links are complete with a long threaded nut closure. Made in France.

NFPA 1983, ANSI/OSHA compliant

		Dimension	Gate	Strength	WLL**	Rating
A. 60510112	12mm Widgate	4.85 x 2"	15/16"	13,780 lbf.	1,378 lbs.	General
B. 60510110	10mm Widegate	4.13 x 1.75"	13/16"	11,020 lbf.	1,100 lbs.	General
C. 60510108	8mm Widegate	3.4 x 1.45"	11/16"	7,165 lbf.	700 lbs.	Technical
D. 60510214	14mm Delta	4.75 x 3.3"	5/8"	19,840 lbf.	1,984 lbs.	General
E. 60510212	12mm Delta	4.1 x 2.9"	19/32"	12,125 lbf.	1,213 lbs.	General
F. 60510210	10mm Delta	3.4 x 2.6"	7/16"	9,920 lbf.	990 lbs.	General
G. 60510310	10mm Semi -Circle	3.4 x 2.7"	5/16"	9,920 lbf.	990 lbs.	General
Stainless Steel						
F. 60511212	12 mm Delta	4.1 x 2.9"	19/32"	19,290 lbf.	1,920 lbs.	General





## ISC ALUMINUM CARABINERS

ISC manufactures an extensive line of superior quality aluminum carabiners. All carabiners conform to EN and ANSI standards and meet NFPA Light Use strength requirements. The unique shape of the ISC carabiners are designed to limit cross-loading. Since the sides of the minor axis are not parallel, cross loading causes the rigging point to slide to the ends resulting in transferring the load to the major axis. Available in Screwgate, Twistlock, Supersafe and ISC's exclusive Quadlock. Gates are color-coded to identify locking style.

		Dimension	Gate	Strength	WLL**	Weight	
<b>A.</b>	<b>201420420</b>	HMS, Screwgate	4.9" x 3.0"	8.8"	6,745 lbf.	675 lbs.	3.5 oz.
	<b>201420430</b>	HMS, Twistlock	4.9" x 3.0"	8.8"	6,745 lbf.	675 lbs.	3.5 oz.
	<b>201420440</b>	HMS, Supersafe	4.9" x 3.0"	8.8"	6,745 lbf.	675 lbs.	3.5 oz.
	<b>201420450</b>	HMS, Quadlock	4.9" x 3.0"	8.8"	6,745 lbf.	675 lbs.	3.5 oz.
<b>B.</b>	<b>201445120</b>	Mongoose, Screwgate	5.2" x 3.6"	1"	6,745 lbf.	675 lbs.	4.2 oz.
	<b>201445130</b>	Mongoose, Twistlock	5.2" x 3.6"	1"	6,745 lbf.	675 lbs.	4.2 oz.
	<b>201445140</b>	Mongoose, Supersafe	5.2" x 3.6"	1"	6,745 lbf.	675 lbs.	4.2 oz.
	<b>201445150</b>	Mongoose, Quadlock	5.2" x 3.6"	1"	6,745 lbf.	675 lbs.	4.2 oz.
<b>C.</b>	<b>201445220</b>	Gecko, Screwgate	4.7" x 2.9"	0.9"	6,745 lbf.	675 lbs.	3.0 oz.
	<b>201445230</b>	Gecko, Twistlock	4.7" x 2.9"	0.9"	6,745 lbf.	675 lbs.	3.0 oz.
	<b>201445240</b>	Gecko, Supersafe	4.7" x 2.9"	0.9"	6,745 lbf.	675 lbs.	3.0 oz.
	<b>201445250</b>	Gecko, Quadlock	4.7" x 2.9"	0.9"	6,745 lbf.	675 lbs.	3.0 oz.



## G-FIRST NFPA ALUMINUM QUIK-LOK

UL Certified NFPA-G

The next step in the Aluminum NFPA-G carabiners. Built upon the successful screwgate version, the Quik-Lok is a 2-stage autolocking design. Manufactured from Alloy Aluminum and heat-treated to meet the stringent NFPA-G requirement, the G-First carabiner is a great leap forward in carabiner design from Omega Pacific.

**Strength:** 8,993 lbf. (40 kN) **WLL:** 899 lbs. (307 kg)

**Gate Opening:** 1.2" (30mm) **Dimensions:** 5.1 x 3" (131 x 76mm)

**Weight:** 4.6 oz. (140gm) **NFPA Rating:** General Use

	Color
<b>60512920</b>	Silver
<b>60512921</b>	Black
<b>60512924</b>	Red



## OFFSET D ALUMINUM WITH CAPTIVE PIN

Pin holds Search Lines in Place

Similar in shape and closure to our OD50 Offset D Steel Carabiner. The addition of the field-installable pin helps keep ropes and cords situation at the base of the carabiner. No longer can your search line come off the carabiner by simply sliding out the gate opening. Available in Screwgate and Twistlock.

**Strength:** 6,745 lbf. (30 kN) **WLL:** 675 lbs. (307 kg)

**Gate Opening:** .827" (21mm) **Dimensions:** 4.5 x 2.75" (113 x 69mm)

**Weight:** 3.25 oz. (92gm) **NFPA Rating:** Technical Use

Meets NFPA 1983/ANSI/OSHA strength requirements.

<b>201421620</b>	Screwgate
<b>201421630</b>	Twistlock



## LUKE OVAL ALUMINUM

Creating a strong oval carabiner is a tough project. Since oval shaped carabiners equalize the load, half to the back and half to the gate, finding the right mix of materials and design is difficult. This is why you will not see a "true" oval with a strength over 5620 lbf (25 kN). Manufactured of forged alloy aluminum, the LUKE has our no-nag, blind gate and is available with screwgate and autolocking (2-stage) gate options.

**Gate Opening:** .8" (20mm) **Strength:** 5620 lbf. (25 kN)

**Weight:** 3 oz. (85 gm)

<b>201441120</b>	Screwgate
<b>201441130</b>	Twistlock



## G-FIRST NFPA ALUMINUM SCREWGATE

UL Certified NFPA-G

The first NFPA Aluminum General Use carabiner from Omega Pacific. Their engineers took the time to create this carabiner from the highest quality allow aluminum and heat-treated it to provide the strength needed to meet NFPA General Use strength requirements. Lightweight and strong. Available in 3 color combinations.

**Strength:** 8,993 lbf. (40 kN) **WLL:** 899 lbs. (307 kg)

**Gate Opening:** 1.2" (30mm) **Dimensions:** 5.1 x 3" (128 x 75mm)

**Weight:** 4.6 oz. (140gm) **NFPA Rating:** General Use

	Color
<b>60512914</b>	Red/Silver
<b>60512910</b>	Silver
<b>60512911</b>	Black







## NFPA ALUMINUM CARABINERS

Rescue Technology aluminum carabiners are designed with quality and utility in mind. Manufactured from high quality alloy aluminum, the sides of the standard size are flattened to give superior performance. Each carabiner is marked with its original strength and manufacturing batch.

**Rating:** Technical Use

Certified by Underwriters Laboratories to NFPA 1983.

		Color	Gate	Dimensions	Major Axis	Open	WLL
A. 6051250*	NFPA 'D' Screwgate	Silver	.625"	4.1" x 2.1"	6,070 lbf.	2020 lbf.	607 lbs.
B. 6051251*	NFPA 'D' Screwgate	Black	.625"	4.1" x 2.1"	6,070 lbf.	2020 lbf.	607 lbs.
C. 6050270	NFPA Offset 'D' Screwgate	Silver	.787"	4.5" x 2.75"	6,745 lbf.	2020 lbf.	675 lbs.
D. 6050271	NFPA Offset 'D' Screwgate	Black	.787"	4.5" x 2.75"	6,745 lbf.	2020 lbf.	675 lbs.
6050272	NFPA Offset 'D' Autolock	Silver	.787"	4.5" x 2.75"	6,745 lbf.	2020 lbf.	675 lbs.
6050278	NFPA Offset 'D' Locksafe	Silver	.787"	4.5" x 2.75"	6,745 lbf.	2020 lbf.	675 lbs.



## ISO COLD FORGED CARABINERS



		Color	Gate	Dimensions	Major Axis	Open	WLL
A. 6050200	11 mm Oval Non-Locking	Silver	.625"	4.2" x 2.3"	4,946 lbf.	1350 lbf.	494 lbs.
B. 6050201	11 mm Oval Non-Locking	Black	.625"	4.2" x 2.3"	4,946 lbf.	1350 lbf.	494 lbs.
C. 6050210	'D' Non-Locking	Silver	.787"	4.3" x 2.4"	6,969 lbf.	2020 lbf.	697 lbs.
D. 6050211	'D' Non-Locking	Black	.787"	4.3" x 2.4"	6,969 lbf.	2020 lbf.	697 lbs.
E. 6050250	'D' Screwgate	Silver	.67"	4.3" x 2.4"	6,969 lbf.	2020 lbf.	697 lbs.
F. 6050251	'D' Screwgate	Black	.67"	4.3" x 2.4"	6,969 lbf.	2020 lbf.	697 lbs.



## ALUMINUM CARABINERS



Larger versions of our NFPA Aluminum carabiners provide a larger gate opening. The Jake is a traditional HMS style carabiner for those who need a large, smooth radius at one end. The Large 'D' is an aluminum version of our popular steel Large 'D' carabiner.

**Rating:** Light Use.

		Color	Gate	Dimensions	Major Axis	Open	WLL
A. 6050279	Jake HMS Screwgate	Gray	1"	4.6" x 3.15"	5,171 lbf.	1800 lbf.	517 lbs.
B. 6050274	Jake HMS Autolock	Gray	.94"	4.6" x 3.15"	5,171 lbf.	1800 lbf.	517 lbs.
B. 6050259	Jake HMS Locksafe	Gray	.86"	4.6" x 3.15"	5,171 lbf.	1800 lbf.	517 lbs.
C. 6051280	Large 'D' Screwgate	Silver	1"	5" x 2.8"	6,745 lbf.	2250 lbf.	675 lbs.
D. 6051281	Large 'D' Screwgate	Black	1"	5" x 2.8"	6,745 lbf.	2250 lbf.	675 lbs.

## TECHNOTE



### Aluminum Carabiner Gate Configuration

The ISC Aluminum Carabiners have color-coded gate barrels for ease of identification. With the exception of the tactical versions, the gate marking is consistent through the HMS, Mongoose, and Gecko Lines.

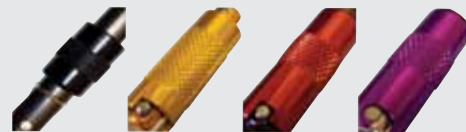

Screwgate

Twistlock

Supersafe

Quadlock

### Units of Measurement

Pounds and kilograms are units of weight measurement (i.e. mass under the influence of gravity). Foot Pounds & kiloNewtons are the correct measurement of the force it takes to break an object. The conversion formula is pounds force(lbf.) = kiloNewtons (kN) divided by .004448.

### ANSI Regulations

ANSI fall protection regulations state that "locking type snap hooks shall have a self-closing, self-locking keeper." This statement is normally interpreted as meaning only auto-locking carabiners (snap-hooks) meet the standard.

### TWISTLOCK vs. SUPERSAFE™

Supersafe gates are triple-action twistlock construction that requires three distinct movements to unlock the carabiner gate.

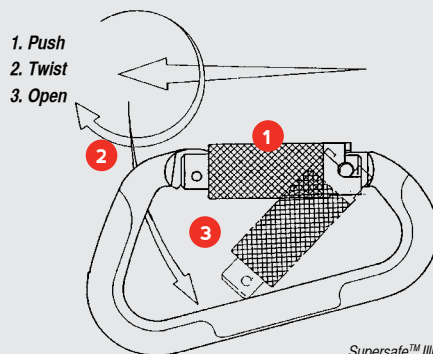

Supersafe™ Illustration

Twistlock gates are the fastest gate locking mechanism to operate. It provides a convenient solution to eliminating the chance that the gate will accidentally be left unlocked.

1. Twist
2. Open

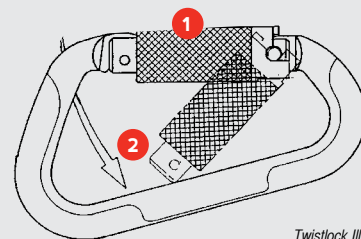

Twistlock Illustration



### IRON WIZARD LADDER HOOK

#### Mid-Sized Rescue Ladder Hook

New Ladder Hook for use where space is limited. Ideal for use in confined spaces to reduce overhead length of rigging systems.

**Strength:** 15,737 lbf. (70 kN) **Dimensions:** 7 x 4" (125 x 73mm)

**Weight:** 19.2 oz. (289gm) **NFPA Rating:** General Use

NFPA 1983, ANSI/OSHA compliant

6051186 Iron Wizard



### ISC RIT RECOVERY HOOK

#### For Turnout Rescue Loop Attachment

Strong, yet lightweight, alloy aluminum locking hooks easily attach to NFPA Drag Loops. Webbing and rope slings can be attached to the rigging eye. Locking mechanism is easy to use while wearing structural gloves.

**Strength:** 8,993 lbf. (72 kN) **WLL:** 1,618 lbs. (735kg)

**Throat Opening:** 2.326" (58mm) **Weight:** 17 oz. (482 gm)

**Dimensions:** 9.5 x 5" (125 x 73mm) **NFPA Rating:** General Use

NFPA 1983, ANSI/OSHA compliant

20149994 Recovery Hook



### TRIPLE ACTION SNAP HOOK

Our new Triple Action Snaphook requires 3 separate actions to open the gate. It retains the same strength and specifications of our standard Autolocking Snaphook. The standard Autolocking Aluminum Snap Hook was selected by RescueTECH for use in our EGRESS Escape Kits and PROBE Searchline kits because of its ease of use and dependability. Manufactured of forged aluminum.

**Strength:** 6,070 lbf. (27 kN) **Weight:** 4 oz. (108 gm)

**Dimensions:** 5.5" x 2.75" (137.5 x 68.8mm)

**Gate Opening:** .88" (22 mm)

20149034 Triple Action Snap Hook



### AUTOLOCKING SNAP WITH FORGED EYE

		Dimension	Gate	Strength	WLL **	Wgt
6053198	Twistlock	5.3" x 2.9"	0.75"	10,000 lbf.	1,000 lbs.	9.6 oz.
6053197	Supersafe	5.3" x 2.9"	0.75"	10,000 lbf.	1,000 lbs.	9.6 oz.

NFPA 1983, ANSI/OSHA/BIS/DIN/EN compliant

\*\*WLL - Recommended Working Load (also known as Safe Working Load) is calculated using the Industrial 10:1 critical use Safe Working Load Ratio.

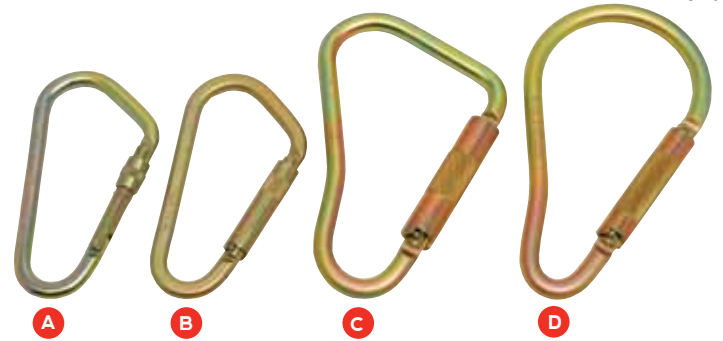

### SCAFFOLD HOOKS

		Dimension	Gate	Strength	WLL **	Weight
A.	201430720	Fireman Side Swing, Screwgate	7" x 3.7"	2.3"	8,993 lbf.	899 lbs. 12.8 oz.
B.	201430730	Fireman Side Swing, Twistlock	7" x 3.7"	2.3"	8,993 lbf.	899 lbs. 14.4 oz.
C.	6053180	Offset Scaffold Hook, Twistlock	8.6" x 5.5"	2.3"	10,100 lbf.	1,010 lbs. 28.8 oz.
D.	6053184	Pear Scaffold Hook, Twistlock	8.6 x 5"	2.1"	7,800 lbf.	780 lbs. 27.5 oz.

NFPA 1983, ANSI/OSHA/BIS/DIN/EN compliant

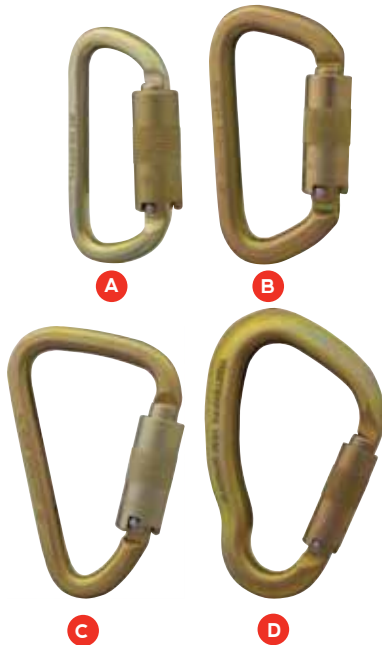

### ANSI CARABINERS

		Gate	Dimensions	Strength	WLL
A.	201430830	Standard D ANSI, Twistlock	.68 in.	4.1 x 2.3"	7,869 lbf. 787 lbs.
B.	201420030	Offset D ANSI, Twistlock	.8 in.	4.25 x 2.5"	11,241 lbf. 1124 lbs.
C.	201420230	Klettersteig ANSI Twistlock	1.0 in.	4.9 x 3.2"	10,000 lbf. 1,000 lbs.
D.	201445530	Big Dan ANSI, Twistlock	1.0 in.	4.8 x 3.5"	11,241 lbf. 1,124 lbs.





## RIGGING SWIVELS

*Bearings Provide a Low Friction Rigging Tool*

A handy tool for use where ropes or rigging must be free to rotate. Great for use in confined space rescues. Stainless Steel is stronger and more durable than comparable sized aluminum swivels.

\*Certified NFPA 1983-G

\*\*Meets NFPA 1983 Strength Specifications

		Length	Strength	WLL**	Opening Diam.	Weight
A. 606468**	Stainless Steel	4.45"	10,000 lbf.	1,000 lbs.	3/4"	9.6 oz.
B. 606501**	CMI Axis™ Swivel	4.35"	9,000 lbf.	900 lbs.	1.25"	5.6 oz.
C. 2354159*	Petzl Aluminum, Large	4.2"	8,093 lbf.	800 lbs.	3/4"	6.4 oz.
D. 2354158	Petzl Aluminum, Small	3.3"	5,000 lbf.	500 lbs.	1/2"	4.0 oz.



## FORGED AUTOLOCKING SNAPS WITH EYES

		Dimension	Gate	Strength	WLL **	Wgt
6053193	Twistlock	6.4" x 3"	1.0"	10,000 lbf.	1,000 lbs.	12 oz.
6053194	Supersafe	6.4" x 3"	1.0"	10,000 lbf.	1,000 lbs.	12 oz.

Snaps are to be used in accordance with current ANSI / OSHA Fall Protection Standards.

NFPA 1983, ANSI/OSHA/BIS/DIN/EN compliant

\*\*WLL - Recommended Working Load (also known as Safe Working Load) is calculated using the Industrial 10:1 critical use Safe Working Load Ratio.



## SWIVEL SNAP HOOK

The Swivel Snap Hook is the next generation of our popular Autolocking Snap Hook. The standard Auto-locking Aluminum Snap Hook was selected by RescueTECH for use in our EGRESS Escape kits and Probe Searchline kits because of its ease of use and dependability. The swivel model takes the twist out of lifelines. It features a Safety Heel to reduce the risk of accidental opening and a 'Blind' nose design, to reduce rope snagging. Manufactured of forged aluminum, the auto-locking gate is easy to open with structural firefighting gloves.

Meets CE EN 362

**Eye Diameter:** .827" (21mm) **Min Breaking Strength:** 6,070 lbf. (27 kN)

**Weight:** 7.13 oz. (202gm) **Gate Opening:** .91" (23mm)

**Dimensions:** 4.5" x 2" (112.5 x 50mm)



20149040

Swivel Snap Hook



## TWISTER SWIVEL CARABINER

An all-aluminum frame swivel for lanyards and lifelines. Manufactured from forged aluminum, the Twister has an MBS of 5,500 lbf (25kN). Available in 2-stage Twistlock and 3-stage Supersafe gate closures.

**Gate Opening:** 5/8" (16mm) **NFPA Rating:** Technical Use

201425530	Twistlock
201425540	Supersafe



## QUICK RELEASE SNAP

*with Swivel*

Quick release under tension. Used where a line might have to be separated quickly from anchor during helicopter lifts, etc. NOT designed for continuous heavy duty use. Full size stainless steel construction.

**Strength:** 10,500 lbf. (46.7 kN) **WLL:** 1,050 lbs (477 kg)

**Bail Diameter:** 5/8" (16mm) **Dimensions:** 4.4 x 2" (110 x 50mm)

**NFPA Rating:** General Use

606302

Heavy Duty Quick Release





# RESCUETECH PULLEYS



## SINGLE & DOUBLE

### RT Pulley Design

Rescue Technology's technical rescue pulleys are built to last. Many of our pulleys are designed without the double bend sideplates found on most pulleys and replaces them with a continuous radius bend. This bend prevents the "un-springing" of the sideplates found in traditional double bend sideplates. The Rescue Technology pulleys also feature weight reducing holes in the sideplates. Most of our pulleys also will accommodate ropes up to 5/8" (16mm). This capacity means that one pulley will handle all of today's NFPA General and Technical Use ropes.

### Bearing VS. Bushing

In rescue loads, the friction difference between bushings and bearings is minimal. It is only with loads that are greater than 5,000 lbf. that you begin to see the difference in friction. Ball bearings can dent the bearing race (brinelling). Sealed bearings can become contaminated with grit and seize. Oil Impregnated bronze bushings are stronger because there is a constant interface between the shaft, bushing, and pulley sheave. The bronze bushing is made from a soft material that will conform to the contaminant.

### Pulley Specifications:

	Dimension	Tread Dia.	Strength	WLL	Weight	Max.Rope Dia.
<b>2" Single</b>	4" x 2.75"	1.6"	8,993 lbf.	899 lbs.	8 oz.	1/2"
<b>2.5" Single</b>	5.1" x 3.45"	2.1"	11,240 lbf.	1124 lbs.	11.2 oz.	1/2"
<b>3" Single</b>	6.25" x 4.15"	2.5"	15,737 lbf.	1574 lbs.	16 oz.	5/8"
<b>2" Double</b>	5" x 2.75" x 2"	1.6"	8,993 lbf.	899 lbs.	13.6 oz.	1/2"
<b>2.5" Double</b>	6.25" x 3.45" x 2"	2.1"	11,240 lbf.	1124 lbs.	19.2 oz.	1/2"
<b>3" Double</b>	7.5" x 4.15" x 2.25"	2.5"	15,737 lbf.	1574 lbs.	28 oz.	5/8"



### RESCUETECH NFPA 2" SINGLE

For Ropes Up to 1/2" Diameter

A pulley that works well for all rescue and work needs. A compact, NFPA General Use 2" pulley that will fit almost all rescue needs. Available in red or black.

Meets NFPA 1983/ANSI/OSHA strength specifications.

### RESCUETECH NFPA 2.5" SINGLE

For Ropes Up to 1/2" Diameter

A new high-strength, long wearing design. Sideplate bend to the 3 carabiner rigging point reduces flexing and stresses put on bends during high load. 3/16" sideplates are designed to protect the rope as it travels through the pulley. 2.5" diameter sheaves are design for smooth running efficiency.

Meets NFPA 1983/ANSI/OSHA strength specifications.

### RESCUETECH NFPA 3" SINGLE

For Ropes Up to 5/8" Diameter

The newest addition to our pulley line that will accept ropes up to 5/8" diameter. Built to the same precision standards and quality of our other pulleys, The NFPA Single, Large is the big daddy of our aluminum rescue Pulleys.

2" Pulley		Color
61082104	Single Bushing	Red
61082101	Single Bushing	Black
61082114	Single Bearing	Red
61082111	Single Bearing	Black

2.5" Pulley		Color
61083104	Single Bushing	Red
61083101	Single Bushing	Black
61083114	Single Bearing	Red
61083111	Single Bearing	Black

3" Pulley		Color
61084104	Single Bushing	Red
61084101	Single Bushing	Black
61084114	Single Bearing	Red
61084111	Single Bearing	Black



### RESCUETECH NFPA 2" DOUBLE

Compact 2" Double Pulley Design

Designed for ropes up to 1/2" Diameter. Lightweight and strong. Great for Technical rescues including tower and water rescue. NFPA General Use. Available in red or black.

Meets NFPA 1983/ANSI/OSHA strength specifications.

### RESCUETECH NFPA 2.5" DOUBLE

Small Sized, Heavy Duty Design

Designed for ropes up to 1/2" Diameter. High strength and lightweight makes this the ideal multi-use pulley for rescue. NFPA General Use. Available in red or black.

Meets NFPA 1983/ANSI/OSHA strength specifications.

### RESCUETECH NFPA 3" DOUBLE

High Efficiency Double Pulley

Designed for ropes up to 5/8" Diameter. Larger sheave diameter increases efficiency of hauling systems. Available in red or black.

Meets NFPA 1983/ANSI/OSHA strength specifications.

2" Pulley		Color
61082204	Double Bushing	Red
61082201	Double Bushing	Black
61082214	Double Bearing	Red
61082211	Double Bearing	Black

2.5" Pulley		Color
61083204	Double Bushing	Red
61083201	Double Bushing	Black
61083214	Double Bearing	Red
61083211	Double Bearing	Black

3" Pulley		Color
61084204	Double Bushing	Red
61084201	Double Bushing	Black
61084214	Double Bearing	Red
61084211	Double Bearing	Black





### 2.5" SINGLE PRUSIK MINDING PULLEY

**Strength:** 9,000 lbf. (40kN) **WLL:** 900 lbs. (454.5kg)  
**Dimensions:** 6.6" x 4.6" (168 x 117mm) **Weight:** 12 oz. (340gm)  
**NFPA Rating:** General Use  
 Meets NFPA 1983/ANSI/OSHA strength specifications.

610634 2.5" Single, Bushing (Blue)



### 2.5" DOUBLE PRUSIK MINDING PULLEY

**Strength:** 10,000 lbf. (46.7kN) **WLL:** 1,000 lbs. (477kg)  
**Dimensions:** 7.5" x 4.6" (187.5 x 117mm) **Weight:** 23.2 oz. (681gm)  
**NFPA Rating:** General Use  
 Meets NFPA 1983/ANSI/OSHA strength specifications.

610644 2.5" Double, Bushing



### RESCUETECH SPIN-LOCK PULLEY

*Uni-Directional Pulley.*

Great for raise / lower systems. Pulley sheave turns one direction making hauling easy and providing friction as the rope is belayed through the device.

**Strength:** 10,120 lbf. (45 kN) **WLL:** 1,120 lbs. (509 kg)  
**Dimensions:** 6.7" x 3.25" x 2.1" (167.5 x 8.3 x 52.5 mm)  
**Weight:** 26 oz. (737 gm)

**NFPA Rating:** General Use  
 Meets NFPA 1983/ANSI/OSHA strength specifications.

2014700 RT Spin Lock Pulley



Aluminum



Stainless Steel

### SINGLE PULLEY WITH BECKET

Specialized rigging pulleys with aluminum or stainless steel sideplates and an aluminum sheave. By using the extra rigging hole at the bottom of the pulley, they can be daisy-chained together in block and tackle fashion.

		Dimensions	Weight	Strength	WLL	Max Rope Dia.		
20140344	Aluminum	5" x 2"	126 x 52 mm	6.3 oz.	7,870 lbf.	787 lbs.	1/2"	13 mm
6102111	Stainless Steel	5.75" X 3.25"	144 x 75 mm	11 oz.	8,500 lbf.	850 lbs.	1/2"	13 mm



### RESCUETECH MICRO PULLEY

A strong pulley in a small package. Made from alloy aluminum, this pulley is perfect for a variety of rescue uses. From Tower Rescue to Water Rescue the RT Micro is one of the most versatile pulleys around. Made for ropes 5/16" - 1/2" Diameter.

**Strength:** single: 8,093 lbf. (46.7kN) double: 8,093 lbf. (46.7kN) **Weight:** 3.2 oz. (90.7gm) 5.6 oz. (158.8 gm)  
**Dimensions:** 2.9" x 1.75" (72.5 x 43.8 mm) 3.5" x 1.75" x 2" (87.5 x 43.8 x 50mm)

**NFPA Rating:** General Use  
 Meets NFPA 1983/ANSI/OSHA strength specifications.

6101151 RT Micro - Black  
 6101154 RT Micro - Red  
 6101284 RT Micro Double - Red



### MICRO STRAP PULLEY

*Economical Personal Use Pulley*

Simple Sideplate design provides extra safety for rescuers. Ideal for 8mm - 7/16" ropes.

**Color:** Red **Strength:** 4,946 lbf. (22 kN)  
**WLL:** 495 lbs. (225 kg) **Dimensions:** 3.2" x 1.75" (75 x 43.75 mm)

**Weight:** 3.2 oz. (90 gm) **Rating:** Technical Use  
 Meets NFPA 1983/ANSI/OSHA strength specifications. BS EN 12278

2014037 Micro Strap Pulley



### RESCUTECH STAINLESS STEEL PMP PULLEY

High strength pulleys designed for ropes up to 5/8" diameter. 2" and 3" sheave diameters. Features high grade stainless steel side-plates and aluminum or Stainless Steel pulley sheave. Extra large rigging point accepts two rescue carabiners. Available with bronze bushing or bearing. Rating: General Use.



Single pulley



Double pulley w/ Becket

#### SINGLE PULLEY

		Sheave	Dimensions	Weight	Strength	WLL	Max Rope Dia.	
61082400	2" Single, Bushing	Aluminum	4 x 2.75"	10.1 oz.	8,993 lbf.	899 lbs.	1/2"	13 mm
61082410	2" Single, Bearing	Aluminum	4 x 2.75"	10.1 oz.	8,993 lbf.	899 lbs.	1/2"	13 mm
61084400	3" Single, Bushing	Aluminum	6.25 x 4.15"	22.2 oz.	11,240 lbf.	1124 lbs.	5/8"	16 mm
61084410	3" Single, Bearing	Aluminum	6.25 x 4.15"	22.2 oz.	11,240 lbf.	1124 lbs.	5/8"	16 mm
61082500	2" Single - Bushing	Stainless	4 x 2.75"	13.5 oz.	8,993 lbf.	899 lbs.	1/2"	13 mm
61082510	2" Single - Bearing	Stainless	4 x 2.75"	13.5 oz.	8,993 lbf.	899 lbs.	1/2"	13 mm
61084500	3" Single - Bushing	Stainless	6.25 x 4.15"	31.8 oz.	11,240 lbf.	1124 lbs.	5/8"	16 mm
61084510	3" Single - Bearing	Stainless	6.25 x 4.15"	31.8 oz.	11,240 lbf.	1124 lbs.	5/8"	16 mm

#### DOUBLE PULLEY W/ BECKET

		Sheave	Dimensions	Weight	Strength	WLL	Max Rope Dia.	
61082700	2" Double, Bushing	Aluminum	4 x 2.75"	16.9 oz.	8,993 lbf.	899 lbs.	1/2"	13 mm
61082710	2" Double, Bearing	Aluminum	4 x 2.75"	16.9 oz.	8,993 lbf.	899 lbs.	1/2"	13 mm
61084700	3" Double, Bushing	Aluminum	6.25 x 4.15"	38.2 oz.	11,240 lbf.	1124 lbs.	5/8"	16 mm
61084710	3" Double, Bearing	Aluminum	6.25 x 4.15"	38.2 oz.	11,240 lbf.	1124 lbs.	5/8"	16 mm
61082600	2" Double - Bushing	Stainless	4 x 2.75"	23.9 oz.	8,993 lbf.	899 lbs.	1/2"	13 mm
61082610	2" Double - Bearing	Stainless	4 x 2.75"	23.9 oz.	8,993 lbf.	899 lbs.	1/2"	13 mm
61084600	3" Double - Bushing	Stainless	6.25 x 4.15"	57.5 oz.	11,240 lbf.	1124 lbs.	5/8"	16 mm
61084610	3" Double - Bearing	Stainless	6.25 x 4.15"	57.5 oz.	11,240 lbf.	1124 lbs.	5/8"	16 mm

### STAINLESS STEEL LITE PULLEY

High strength pulleys designed for ropes up to 5/8" diameter. 3" sheave diameters. Features high grade stainless steel sideplates and aluminum pulley sheave. Extra large rigging point accepts two rescue carabiners. Available with bronze bushing or sealed needle bearing.

Rating: General Use.



		Dimensions		Weight	Strength	WLL	Max Rope Dia.	
6102005	3" Single, Bushing	6.4 x 4"	160 x 100 mm	22 oz.	16,000 lbf.	1,600 lbs.	5/8"	16 mm
6102005D	3" Double, Bushing	7 x 4"	184 x 108 mm	38 oz.	20,000 lbf.	2,000 lbs.	5/8"	16 mm

### STAINLESS STEEL PULLEY

Built to be tough and durable at an economical price. Plain sideplates with rigging points that accommodate two rescue carabiners. Stainless Steel sideplates and axle for extra durability. Available with sintered bronze bushing or needle bearing.

Rating: General Use



#### SINGLE PULLEYS

		Dimensions		Weight	Strength	WLL	Max Rope Dia.	
6102118	3" Bushing, Steel	5 x 5.2"	125 x 63 mm	11.6 oz.	8,000 lbf.	800 lbs.	1/2"	13 mm
6102118A	3" Bushing, Aluminum	5 x 5.2"	125 x 63 mm	7.7 oz.	8,000 lbf.	800 lbs.	1/2"	13 mm
6102122	4" Bushing, Aluminum	8 x 4.5"	200 x 112 mm	35 oz.	20,000 lbf.	2,000 lbs.	5/8"	13 mm
6102123	4" Bearing, Aluminum	8 x 4.5"	200 x 112 mm	35 oz.	20,000 lbf.	2,000 lbs.	5/8"	13 mm

#### DOUBLE PULLEYS W/ BECKET

		Dimensions		Weight	Strength	WLL	Max Rope Dia.	
6102119	2" Bearing, Aluminum	6.25 x 2.5"	162 x 62 mm	13 oz.	11,000 lbf.	1,200 lbs.	1/2"	13 mm
6102120	2" Bushing, Steel	6.25 x 2.5"	162 x 62 mm	20 oz.	11,000 lbf.	1,200 lbs.	1/2"	13 mm
6102120A	2" Bushing, Aluminum	6.25 x 2.5"	162 x 62 mm	13 oz.	11,000 lbf.	1,200 lbs.	1/2"	13 mm
6102124	4" Bushing, Aluminum	9 x 4.5"	225 x 112 mm	60 oz.	25,000 lbf.	2,500 lbs.	5/8"	16 mm





## NFPA STAINLESS STEEL PULLEYS

Meets Construction and Strength Requirements of NFPA 1983

### SINGLE PULLEYS

Rating: Technical Use

Top to Bottom: 4" NFPA Single, 2" NFPA Single

### DOUBLE PULLEYS

Rating: General Use

Top to Bottom: 4" NFPA Double, 2" NFPA Double (not available)

		Dimensions		Weight	Strength	WLL	Max Rope Dia.	
6103117	2" Single, Bearing	5 x 5.2"	125 x 63 mm	7.7 oz.	8,000 lbf.	800 lbs.	1/2"	13 mm
6103122	4" Single, Bushing	8 x 4.5"	200 x 112 mm	35 oz.	20,000 lbf.	2,000 lbs.	5/8"	16 mm
6103123	4" Single, Bearing	8 x 4.5"	200 x 112 mm	35 oz.	20,000 lbf.	2,000 lbs.	5/8"	16 mm
6103124	4" Double, Bushing	9 x 4.5"	225 x 112 mm	64 oz.	25,000 lbf.	2,500 lbs.	5/8"	16 mm
6103125	4" Double, Bearing	9 x 4.5"	225 x 112 mm	64 oz.	25,000 lbf.	2,500 lbs.	5/8"	16 mm



## EASY LIFT EVACUATION PULLEY

For Ski Lift Rescues

Designed to be connected directly to the main ski lift cable for lift evacuations. Manufactured of alloy aluminum body, nylon sheave, and stainless steel gate. Must be used with back-up lanyard and belay system.

Works on cable up to 2.2"

Strength: 6,745 lbf.

Weight: 52.8 oz.



23896104

Evacuation Pulley



## STAINLESS STEEL TROLLEY PULLEY

For Steel Cables

Sheaves turn on Sealed Ball Bearing for smooth, wobble-free use. Oversized stainless steel sideplates extend well beyond the sheaves to protect them from hard use. A rear slot allows a steel carabiner to surround the cable, allowing redundancy from the cable to the load.

Dual Hardened Sheaves that will accommodate 3/8" or 1/2" cable.

Weight: 32.8 oz. Rating: Technical Use

6102221

Steel Cable



## ALUMINUM TRIPLE SHEAVE PULLEY

The only aluminum triple sheave pulley with rotating sideplates. Designed for 7/16" - 5/8" ropes. Can be reeved at any point on the line. High strength alloy aluminum construction with Oilite® Bushing or Sealed Bearing. Triple carabiner rigging point.

Color: Gold Strength: 15,000 lbf.

WLL: 1,500 lbs. Dimensions: 10" x 4" x 4.5"

Pitch Diameter: 3.5" Weight: 4.25 lbs.

Rating: General Use

Meets NFPA 1983/ANSI/OSHA strength specifications for Pulleys

610034

4" Triple, Bushing

610034B

4" Triple, Bearing



## STAINLESS STEEL TRIPLE SHEAVE PULLEY

Super-Strong and Super-Durable. Rigging Hole accommodates 3 large rescue carabiners.

For rope diameters 3/8" - 5/8".

Strength: 30,000 lbf. WLL: 1,500 lbs.

Dimensions: 8" x 4.5" Weight: 5.25 lbs.

Rating: General Use

Meets NFPA 1983/ANSI/OSHA strength specifications for Pulleys

6102134

Bushing

6102135

Bearing





### RESCUETECH EXTRACTOR™ CSR HAULER

The EXTRACTOR™ CSR HAULER pulley features an integral safety cam to secure the progress of hauling systems. The first in a series of Rescue Technology pulleys that meet the rugged requirements of Rope Rescue Technicians, the EXTRACTOR™ CSR HAULER is designed for 1/2" Life Safety Rope and will accommodate ropes from 3/8" - 9/16". Special safety cam design is rope friendly and can be locked out of the way when a standard double pulley is needed. Super-strong, the EXTRACTOR™ CSR HAULER has an 1,100 lb. safe Working Load Limit.

**Dimensions:** 8.75" x 3.1" x 2.2" **Rating:** General Use  
Meets NFPA 1983/ANSI/OSHA strength specifications.

614024	RT Extractor CSR, Double
614014	RT Extractor CSR, Single
614024C	Replacement Cam Release Cord



### MICRO CSR PULLEY

The perfect size for light use and tower rescues. Ideal for 8mm - 7/16" ropes. Works with ropes up to 1/2". Built-in safety cam holds rope for use in "Jigger" or "Short-Haul" Systems.

**Color:** Purple **Strength:** 7,000 lbf. (31 kN)  
**WLL:** 700 lbs. (318 kN) **Dimensions:** 6" x 2" (152 x 51 mm)  
**Weight:** 8.8 oz. (226 gm) **Rating:** Technical Use  
Meets NFPA 1983/ANSI/OSHA strength specifications.

614321	Micro CSR Pulley
--------	------------------



### KNOT PASSING PULLEY

*Ideal For Use As Carriage Pulley*

Heavy duty knot passing pulley. Rotating sideplates and a rigging point that will accommodate three 13mm rescue carabiners. Aluminum pulley sheave with Oilite® Bushing for durability. The Wide Pulley is designed for ropes up to 1/2" diameter. The large hole in center of the sideplates will accept an Pear Shaped Scaffold Hook carabiner for balanced hauling when unit is used as the top support pulley in rope traverse systems.

**Color:** Red  
Meets NFPA 1983/ANSI/OSHA strength specifications for Pulleys

610015	Medium
610016	XLarge



### KOOTENAY PULLEY

*Designed for passing knots in rope.*

High efficiency sealed ball bearings. Locking pins allow use as an anchor.

**Fits ropes from:** 5/16" to 3/4"  
**Strength:** 8,992 lbf. **Dimensions:** 4" x 2" x 1.75"  
**Weight:** 50.4 oz. **Height:** 10.25"  
**Rating:** General Use

2354067	Kootenay Pulley
---------	-----------------



### STAINLESS STEEL CARRIAGE PULLEY

*Durable Aluminum Sheave*

The most versatile Knot-Passing / Highline pulley yet. Extra-wide 3" sheave easily passes knots in 1/2" rope. Large center rigging hole accepts up to three large carabiners, two smaller holes provide tagline attachments. Pins stowed directly on sideplates install to lock the sheave, allowing the pulley to be used as a high-strength tie off.

**Strength:** 15,000 lbs. **Efficiency:** 91.4%  
**Dimensions:** 8.5" x 4" **Weight:** 40 oz.  
**Rating:** General Use  
Meets NFPA 1983/ANSI/OSHA strength specifications for Pulleys

6102143	S.S. Carriage Pulley
---------	----------------------



### ROCK EXOTICA OMNI-BLOCK PULLEYS

The Rock Exotica™ OMNI BLOCK® is a mix of the old and the new. Up to now, rescue pulleys have been the standard side swing plate models that involve rotating the side plate and the introduction of the rope into the sheave. Increased strength is cited as the main reason that life safety pulleys are designed this way. Incredibly quick to attach, the Rock Exotica Omni Block is a high strength, swiveling rope block/pulley. Each precision fabricated alloy block has a unique button-activated release feature that allows instant access to the sheave for midline attachment. The attachment eye accepts most carabiners and snaps.

**Pulley 1.5" and accepts up to 1/2" rope.**

**Strength:** 8,093 lbf. (36 kN) **WLL:** 899 lbs. (409kg.)

**Pulley Tread Dia.:** 1.6" **Dimensions:** 5.25" x 2.5"

**Weight:** 8.8 oz. (single) 14.4 oz. (Double)

**Rating:** General Use

Meets NFPA 1983/ANSI/OSHA strength specifications for Pulleys

		Color
2438161514	1.5 Single	Red
2438161511	1.5 Single	Black
2438162514	1.5 Double	Red
2438162511	1.5 Double	Black



### OMNI-BLOCK 2.0

A PMP version of Rock Exotica's Omni Block. The Omni-Block 2.0" features a one-sided PMP function and swiveling rigging point.

**Weight:** 12.3 oz (348 gm) **Breaking Strength:** 8,093 lbf (36 kN)

**Working Load:** 800 lbs. (8 kN) **Max Rope Diameter:** 1/2" (13 mm)

**Sheave Diameter:** 2.0" (51 mm)

		Color
24381615210	2.0 Single	Red
24381615211	2.0 Single	Black



### ROCK EXOTICA AZTEK OMNI PULLEY SET

The special Rock Exotica pulley used in the Aztek "set-of-fours" system. When configured, these double blocks will enable the rescuer greater versatility in a personal mechanical advantage (PMA) for rescue and general rigging. Machined from a solid block of high strength aluminum the Aztek pulleys have two different style blocks and are color-coded for ease of identification.

**Strength:** 8,093 lbf. (36 kN) **Dimensions:** 4" x 2" x 1.75"

**Rating:** General Use

Meets NFPA 1983/ANSI/OSHA strength specifications for Pulleys.

243816410	Aztek Pulley Set
243816419	Aztek Prusik Pin



Double

Single

### 2.0 PMP

The Omni Block 2.0 features a 2" sheave for better efficiency when hauling heavy loads.

**Fits ropes up to:** 1/2" (13mm) diameter

**Sheave Diameter:** 2.0" (51mm) **Strength:** 8,093 lbf. (36 kN)

**WLL:** 1799 lbf (8 kN) **Dimensions:** 5.8 x 3" (148 x 76mm)

**Weight:** 12.3 oz. (344 gm)

		Color
243816310	Single	Copper
243816311	Single	Black
243816320	Double	Copper
243816321	Double	Black

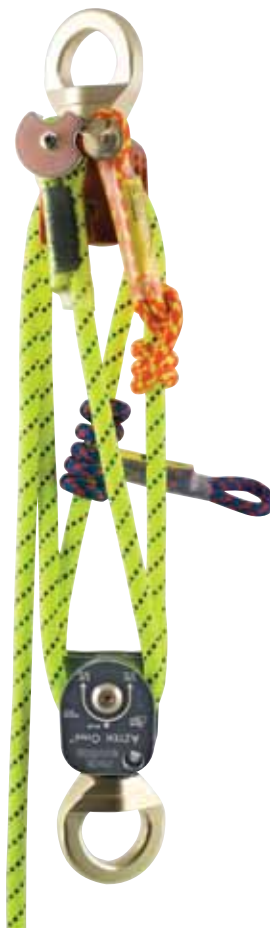

### AZTEK 4:1 EDGE MANAGEMENT PULLEY SET

This is a compact mechanical advantage system that provides rescuers with a versatile edge management and rigging set. Some of the uses are as a pick off, travel restrict, adjustable directional, high directional guy-line, high angle attendant tether, high angle litter scoop, load release hitch and much more.

Both AZTEK pulleys have their own color-coded Prusik and can be easily activated or deactivated. This means you can have the ratchet at either the top pulley or the bottom pulley. The special 3 on 2 Prusik cannot come off the rope, so the deactivated Prusik will stay ready to be used as soon as you need it. Set includes AZTEK Pulleys, Aztek rope set (50' of 8mm, 2-6mm Ratchet Loops, 1-6mm Travel Restraint Loop) and waist pack.

61051301





### ANTHRON HANDLED ASCENDER

*A great new handled ascender.*

Manufactured of aluminum, the Anthon fits ropes 8mm - 1/2" in diameter. Special grip material on handle is very comfortable and is slip-resistant.

**Dimensions:** 7.6" x 3.6" (190 x 90mm) **Weight:** 8.5 oz (204 gm)

**NFPA Rating:** General Use

Meets NFPA 1983 strength specifications for ascenders.

		Color
602301	Left Hand	Gold
602302	Right Hand	Blue



### ANTHRON BLOQUER MINI ASCENDER

*Ascender for Rope Access*

Manufactured of aluminum, the Bloquer fits ropes 8mm - 1/2" in diameter. The Bloquer may be used as a chest or small ascender. It may be attached to the harness with flat webbing or carabiner. It possess an auxiliary hole into which a second carabiner can be inserted, preventing so the rope from falling out of the groove during climbing. Works with our new VANGUARD II, PRIME, and ADVANTAGE harnesses. Fits ropes 8mm - 1/2".

**Color:** Blue **Dimensions:** 4.75" x 3.25" x 1.4" (118.8 x 81.3mm)

**NFPA Rating:** General Use

Certified EN567. Meets NFPA 1983 strength specifications for ascenders.

602305	Bloquer Ascender
--------	------------------



### ANTHRON CHEST ASCENDER

*Chest Ascender for Rope Access*

Manufactured of aluminum, the Anthon fits ropes 8mm - 1/2" in diameter. Works with our new VANGUARD II, PRIME, and ADVANTAGE harnesses.

**Color:** Blue **Dimensions:** 4.6" x 2.9" (115 x 72.5mm)

**Weight:** 4.9 oz. (118 gm) **NFPA Rating:** General Use

Meets NFPA 1983 strength specifications for ascenders.

602306	Chest Ascender
--------	----------------



Top: Ultrascender (Black)  
Bottom: Ultrascender (Red)

### ULTRASCENDER

One of the strongest open-sided ascenders available. Machined from solid aircraft aluminum extrusion with 4140 chrome-moly steel cam with a new non-metallic finish that has the same corrosion resistance as stainless steel and is harder than knife blades and files. The unit will accommodate ropes from 1/4" (6mm) to 5/8" (16mm) in diameter. Special safety gate design is superior to other open-sided ascenders. Attach to carabiners, ascender slings, or combination. Set includes one right and one left hand unit.

**Strength:** 5,000 lbf (22.2 kN) **Weight:** 20 oz. (480 gm)

**Rating:** General Use **Dimensions:** 7.25" x 3" (181.3 x 75mm)

Meets NFPA 1983 strength specifications for ascenders.

		Color
6020031N	Pair	Black
6020034N	Pair	Red



### ASAP<sup>®</sup>

Mobile fall arrest device for rope.

• For use on 11 - 13mm lifelines • Stops a fall, a slide or uncontrolled descent • Locks even if the device is grabbed during a fall • Works on vertical or angled rope • Moves up and down along the rope without manual intervention • Easy to install/remove at any point on the rope • Can be used with an energy absorbing lanyard

23540271	ASAP
2354127120	Asap'sorber, 20 cm
2354127140	Asap'sorber, 40 cm

### ISC RED BACK-UP DEVICE

Designed to replace current mechanical prusiks. ISC designed the RED to accommodate the safety needs of the rope access market. Fully CE approved to EN1284. The RED will take on a two-person rescue load, is self-parking (rather than self-tailing) and is towable so as to be used with current web and rope lanyards. The RED's cams have a positively locking spring which maintains the devices position on the rope. Another RED feature is the use of "rotational braking" When loaded, the RED rotates clockwise in relation to the main line creating friction resulting in a very effective automatic braking. Panic braking accomplished by pulling on the "Popper" break-away tow cord. Rated capacity: 528 lbs (240 kg). Peak loads under 6 kN. Self-Parking. Compatible with RescueTECH 7/16" ACCESS Lifelines (other ropes may be tested on request).

20148924	ISC Red Back-up Device
----------	------------------------



## GIBBS ASCENDER

### New Spring Design

One of the strongest closed cam type of rope-grab ascenders. Rounded tooth cam design minimizes rope wear yet holds on wet or icy ropes. New spring attachment increases cam's range of motion to decrease chance of spring breakage. 1/2" model attaches to synthetic ropes 5/16" to 1/2"; 3/4" version accommodates synthetic ropes from 5/8" to 3/4". The spring-loaded type is always in locked position and is recommended for general rescue use. For use on kernmantle rope only.

Meets NFPA 1983 strength specifications for ascenders.

		Cam Type	Strength	Weight	Rating
A. 602011	1/2" Aluminum, Free Running	Forged	2,500 lbf.	7 oz.	Technical
B. 602012	1/2" Aluminum, Spring Loaded	Forged	2,500 lbf.	7 oz.	Technical
C. 602012F	1/2" Aluminum, Spring Loaded	Forged	5,200 lbf.	9.2 oz.	General
D. 602112	1/2" Stainless Steel, Spring Loaded	Forged	5,200 lbf.	12 oz.	General
E. 602013	3/4" Aluminum, Spring Loaded	Forged	5,200 lbf.	14 oz.	General
F. 602113	3/4" Stainless Steel, Spring Loaded	Forged	5,200 lbf.	20 oz.	General
G. 602201	Replacement Spring Kit (Ascender not included)				



## ISC RESCUE ASCENDER

### New Pin Design

Manufactured from high strength aluminum alloy. Machined from thick walled extrusion for extra durability. Shell has special curved rope interface section for superior rope strength and minimized rope damage. Rigging point will accommodate all of our carabiners and will pass many locking collars. Quick-attach pip pin for easy attachment. For use on kernmantle rope only.

**NFPA Rating:** General Use

Meets NFPA 1983 strength specifications for ascenders. BS EN 567 Certified as Rope Clamps

		Rope Dia.
602251	Standard	7/16" - 1/2"
602252	Large	5/8"



## GIBBS SLINGER™

We combine the rescue versions of the 1/2" Gibbs Ascender with our high strength 1" Flat web to create a versatile rope grab system that virtually eliminates torsion loads on the rope grab and carabiner.

Meets NFPA 1983 strength specifications for ascenders.

602212A	Aluminum
602212S	Stainless Steel



Top: Stainless Steel; Bottom: Aluminum

## CMI ROPEWALKER ASCENDER

Manufactured from alloy aluminum or stainless steel and forged aluminum cam. Large attachment point accommodates multiple carabiners. Unique spring design allows for easy adjustment of tension. Spring tested to over 1 million cycles. 3/8" to 5/8" diameter rope capacity. Pin can be inserted from either left or right side to accommodate needs of rescuer. 3 sigma rated to 7,700 lbf. For use on kernmantle rope only.

**NFPA Rating:** General Use.

Meets NFPA 1983 strength specifications for ascenders.

602241	Aluminum
602245	Stainless Steel



## INDUSTRIAL ROPE GRAB WITH LANYARD

### For Vertical Lifelines

Stainless steel fall arrest device especially designed for vertical applications. Unlike other cam-type grabs, these grabs slip before rope failure. Rope Grab clutching effect begins at 1,000 lbf. on 1/2" ropes. For this reason use ONLY on the correct diameter rope. These grabs have the 2" diameter rigging hole to prevent rollout of attaching snaps. Comes with a permanently attached nylon lanyard equipped with a double locking snap hook. Manufactured in the U.S.A.

**Weight:** 1.5 lbs. **Rating:** General Use  
 Meets all OSHA, NFPA, CSA, and ANSI standards for rope grabs and ascenders.

6025241	1/2" Ropes
6025251	5/8" Ropes



## FOOT ASCENDER

A compact foot ascender for rope climbing systems. Machined from aluminum extrusion. Locking mechanism holds unit on the rope. Includes adjustable webbing straps.

602247	Right
602248	Left



## ROCKER

The Rocker can be fitted to the rope at any point. It can be used hands-free, when travelling up and down the rope and has been designed for use without a Shock-absorber. The Rocker can also be used as a Rope Adjuster on a Work Positioning Lanyard or Flip-line (in accordance with EN358). The Thumb-catch allows the Rocker to be 'parked' on the rope for Work Positioning or use as a Rope Access back-up device. Non-aggressive 'rope friendly' cam faces reduce wear on rope. Designed for 7/16" ropes.

602600	Rocker, Aluminum
620601	Rocker, Stainless Steel



## PERSONAL CSR / TRANSFER KIT

### Built-In Safety Cam

Great tool for rescuers transferring the victims load to a new rescue line. Can be used as either a 4:1 or 5:1 system. Works like a "power-assist" pick-off strap. Utilizes the Micro CSR Pulley for hauling safety. Complete with storage pouch that will attach to rescue harness.

**WLL:** 600 lbs. **Weight (48" version):** 41.6 oz.

614433	Autolock, 48" Lift
614436	Screwgate, 48" Lift
614433-10	Autolock, 10 ft. Lift
614436-10	Screwgate, 10 ft. Lift



## MINI-HAUL - LIGHT

### Includes Storage Bag

A mini 4:1 / 5:1 Hauling system for those time where you don't need to deploy your long ropes and heavy pulleys. Perfect for litter attendants, edge transitions, and much more. Comprised of our 7/16" ACCESS Lifeline (30'), RescueTECH Double Mini Pulley (2), OD50 Carabiners (2), Prusik Cord, and pouch (will attach to harness).

**Tested Strength to Prusik failure:** 5,500 lbf.  
**Ultimate Strength:** 7,000 lbf. **Light Use. WLL:** 600 lbs.

614405	Screwgate
614406	Autolock



## MINI-HAUL - GENERAL

### Includes Storage Bag

A full-sized 4:1 / 5:1 Hauling System for all types of rescues. Perfect for load transfer, short haul distances, pre-rigs, and much more. Comprised of our 1/2" ACCESS Lifeline (30'), RescueTECH Double PMP (2), OD50 Carabiners (2), Prusik Cord, and pouch (will attach to harness).

**Ultimate Strength:** 9,000 lbf. **General Use. WLL:** 600 lbs.

614412	Screwgate
614413	Autolock





### ISC A-B DESCENDER

#### Superior Control vs. Competition

Special descender with a 500 lb. Working Load Limit. Complete with a double action anti-panic handle. Manufactured from aluminum alloy. 100% inspected and function tested. Works on rope diameters: 10.5 - 12mm. ALWAYS test your personal rigging method to assure sufficient friction for a safe descent.

**Dimensions:** 8" x 3" (200 x 75mm) **Strength:** 5,000 lbf. (22.2 kN)

**NFPA Rating:** General Use

Meets NFPA 1983/ANSI construction specifications for Descenders.

601340 ISC A-B Descender



### ANTHRON DOUBLE STOP DESCENDER

A manually operated controlled descent device that utilizes a cam assembly that provides friction on the rope to hold a load, or allow the load to descend. To begin descent, the user depresses the control lever. If the control lever is fully depressed in a panic situation, the descent will stop. Normally, connected directly to the users seat harness, the Anthon may be attached to a rigging point and used as a lowering device. Can be placed on the rope at any point. For 3/8" - 7/16" ropes. Best control with 7/16" ropes.

**WLL:** 300 lbs. (136.4 kg) **Dimensions:** 7.5 x 3.3" (187.5 x 82.5mm)

**Weight:** 13.6 oz. (386 gm)

Meets NFPA 1983/ANSI construction specifications for Descenders.

		Rope Dia.
60100976	Anthon Descender	Blue
60100971	Anthon Descender	Black



### D4 BELAY DESCENDER

Special descender / belay device that easily controls 500 lbs loads. Side plate closes with low-profile, spring loaded safety catch. Simple functional design. Can be placed onto the rope without removing rigging carabiner. Rotate handle counter-clockwise to lock in place. Rotate right to descend or lower load. Rotating handle too far clockwise will engage panic stop function. Continued clockwise rotation re-sets the unit. The D4 is a true panic stop device rather than a panic brake device. The difference is that once the panic stop is activated, no other force must be applied to the device. A panic brake style device requires a force input to continue the braking function. Can be used for progress capture in hauling systems and allows rapid conversion between raising and lower. For 7/16" ropes (1/2" version coming soon)

**Weight:** 1.4 lbs (550 gm)

**Dimensions:** 7" x 3.25" x 3" (175 x 81.25 75mm)

**Rating:** General Use

20148804 D4 Belay Descender



### PETZL I'D® NFPA

#### For Descending and for Belaying, with an Anti-Panic function.

Swinging side plate with safety catch decreases risk of dropping device and allows rapid installation of the rope into the device. Anti-error feature helps avoid accidents due to incorrect installation of the rope in the device. Self-braking system: if the handle is released during descent, the cam rotates to pinch the rope and brake the user's descent. Anti-panic handle: the I'D® will lock onto the rope if the user pulls too hard on the handle. To descend, simply pull on the handle; the rate of descent is controlled by varying the grip on the free end of the rope with the other hand. For work positioning, the handle can be rotated to secure the I'D® in place on the rope, thus eliminating the need to "tie off" the device. May be used as a progress capture device in a haul system; allows rapid conversion between raising and lowering. Individually tested.

**Weight: Large:** 22.4 oz. (625 gm) **NFPA Rating:** General Use

CE EN 341 class A, Large: NFPA G. Small: NFPA

		Rope Dia.
2354120N	Large - NFPA G	11.5-13 mm
2354120S	Small - NFPA L	10 - 11.5 mm



### TUBA® BELAY TUBE

Designed for lowering loads over long distances. The braking power is easily adjusted by varying the number of turns of rope around the device. Special shape allows the passage of a knot, allowing several ropes to be joined together for long lowers.

**Weight:** 41.6 oz. (1.2 kg) **Rating:** General Use

Meets NFPA 1983/ANSI construction specifications for Descenders.

2354212 Tuba



### 540 RESCUE BELAY

A mechanical belay device specifically engineered for fire service and industrial rescue teams. Simple and easy to use. Symmetrical design allows for bi-directional loading. Self-locking with sudden falls. Built-in release lever eliminates need for release hitch. Passes rescue belay competence criteria. UL Certified NFPA 1983. 1 year manufacturer's warranty.

**Strength:** 9,000 lbf. (40 kN) **Weight:** 24 oz. (680 gm)

**Rating:** General Use

2154540	Large (11.5 - 13mm)
2154541	Small (10.6 - 11.6mm)
899522	540 Belay Video



### RESCUETECH RAPPEL RACK

This is the classic design developed in the 1960's. Primarily designed as a personal rappel device on a single rope 3/8" to 1/2" in diameter. Top Bar and Top Bar - Hyperbar has a training groove on one side to assist in guiding the rope and aid in proper rigging.

**Length:** 14" (35 cm) **Weight:** 24.8 oz. (703 gm)

**NFPA Rating:** Technical Use

Meets NFPA 1983/ANSI construction specifications for Descenders.

601024W

Rappel Rack

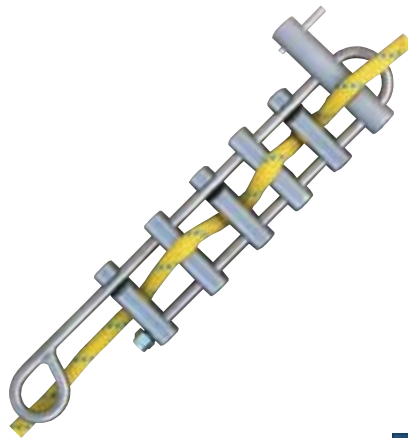

### RESCUETECH RESCUE RAPPEL RACK

This is an upgraded version of our popular rappel rack. Large bars provide greater strength and control of rescue loads. Top Hyperbar aids in lock-offs. Grooved bars help guide the rope through the rack.

**Length:** 14" (35 cm) **Weight:** 28.8 oz. (816 gm)

**NFPA Rating:** General Use

Meets NFPA 1983/ANSI construction specifications for Descenders.

601124

RescueRappel Rack

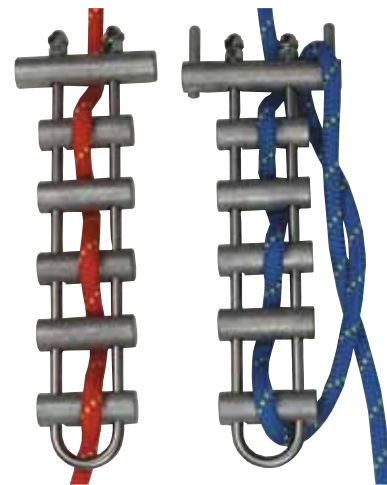

A

B

### RESCUETECH RESCUE RACK™

*Superior Control of Rescue Loads*

The safest, heavy duty lowering and rappelling device. Can be placed onto rope at any point. Friction may be varied by sliding easily rigged bars up or down - even while on rappel or during lowering operations. Specially designed straight cut 1" aluminum friction bars help prevent mis-rigging. Extended top bar for quick lock-off. Accommodates ropes from 1/4" to 1 1/2" or double ropes up to 3/4". One person can easily control a 1,000 lb. load. Frame manufactured of 304 stainless steel and will accommodate four 13mm carabiners. Special design of the frame distributes the load between both sides of the unit.

**Tensile Strength:** 10,000 lbf. (44.5 kN) **WLL:** 1,000 lbs. (455 kg)

**Dimensions:** 14" (35 cm) **Weight:** 35.2 oz. (997 gm)

**NFPA Rating:** General Use

Meets NFPA 1983/ANSI specifications for Descenders.

A. 601102

Standard

B. 601202

Hyperbar

## WARNING

CAUTION: Care must be taken when using the Steel Brake Bars to rappel, belay, or lower personnel or heavy loads. Steel does not provide as much friction as aluminum.



### CMI MINI RESCUE RACK

A handy alternative for shorter drops and lighter loads. Similar in design to the standard CMI Rescue Rack by uses 5/16" Stainless Steel for the frame and aluminum for the brake bars. Top bar is oversized with a single lock-off pin. Pre-assembled with two fixed and two straight slotted bars.

**Weight:** 11 oz. (311 gm) **Dimensions:** 8.25" x 3.5" (20.6 x 9 cm)

**Strength:** 14,000 lbf. (62 kN) **WLL:** 1400 lbs (636 kg)

**Rating:** General Use

Meets NFPA 1983/ANSI specifications for Descenders.

601112

Standard HyperBar

601113

Double HyperBar



### CMI NFPA RAPPEL RACK WITH HYPERBAR

Welded eye construction available in parallel or 90° to the bars. All welds are Zygo inspected to insure reliability. The rack comes pre-rigged with six angle slotted Stainless Steel bars.

**Length:** 15" (38.1 cm) **Weight:** 31.2 oz. (884 gm)

**Strength:** 10,000 lbf. (44.5 kN) **WLL:** 1000 lbs. (455 kg)

**Rating:** General Use

Meets NFPA 1983/ANSI specifications for Descenders.

601034N

Standard

6010349N

90° Rigging Point

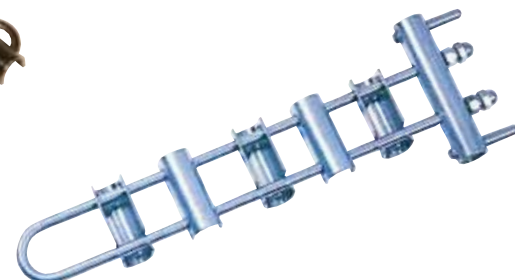

### CMI RESCUE RACK

*Oversized Aluminum Top Bar and Stainless Steel Friction Bars*

3/8" diameter stainless steel frame fitted with oversized aluminum top bar and 5 stainless steel brake bars. To compensate for the reduced friction inherent in stainless steel bar, the diameter of the friction surface is a full 1". The special "open back" design of the bars help avoid improper rigging. Hyperbar model features stainless steel top bar with two lock-off pins.

**Length:** 15" (38.1 cm) **Strength:** 19,000 lbf. (84.5 kN)

**Weight:** 32.8 oz. (930 gm) **NFPA Rating:** General Use

Meets NFPA 1983/ANSI specifications for Descenders.

601111S

Standard

Weight

32.8 oz.



### RESCUETECH™ STEEL RESCUE 8

#### Three Dimensional Design

Forged Steel Rescue 8 Descender. For ropes up to 3/4" diameter. Three dimensional design allows user to vary friction depending on which way the descender is used. Drop forged. Chromium Plated Silver.

**Tensile Strength:** 15,000 lbf. (66.7 kN) **WLL:** 1,500 lbs. (682 kg)

**Dimensions:** 6.5" x 6" (16.5 x 15.2 cm) **Weight:** 24 oz. (680 gm)

**Rating:** General Use

Meets NFPA 1983/ANSI construction specifications for Descenders.

	Color
6010070	Silver
6010071	Black



### RESCUETECH™ STAINLESS STEEL COMPACT RESCUE 8

A small rescue 8 with the durability and strength of Stainless Steel. Only 5.7" long, this tough unit will fit into almost all rescue kits.

**Dimensions:** 5.7" x 5.3" (14.5 x 13.5 cm) **Weight:** 15.2 oz. (431 gm)

**Strength:** 9000 lbf.

240180510



Descender Link shown with BailOut 8 (not included)

### RESCUETECH™ DESCENDER LINK

A multiple loop extension for descenders. Built with the same high strength design as our daisy chains, the directional loops allow multiple adjustments of the overall length of the descender system.

**Weight:** 2.4 oz. (68 gm)

758124	Descender Link
--------	----------------



### RESCUETECH™ ISC RESCUE 8 DESCENDER

Our alliance with ISC has created several new items such as this classic aluminum rescue descender. Made from forged aluminum for great wear resistance.

**Dimensions:** 6.75" x 6" (17.2 x 15.2 cm) **Weight:** 7.2 oz. (204 gm)

**Minimum Strength:** 7,886 lbf. (35 kN)

**NFPA Rating:** General Use

Meets NFPA 1983/ANSI construction specifications for Descenders.

	Color
60114111	Charcoal
60114110	Silver



### RESCUETECH™ FIGURE 8

#### Traditional Design

The RescueTECH Figure 8 is an economical anodized figure 8 descender for light duty use. Forged aluminum construction.

**Rappel/Belay Usage Strength:** 7,000 lbf (31 kN)

**WLL:** 700 lbs. (318 kg) **Dimensions:** 5 1/2" x 2 7/8" (14 x 7.3 cm)

**Weight:** 4 oz. (113 gm) **Rating:** General Use.

Meets NFPA 1983/ANSI construction specifications for Descenders.

	Color
601311	Black
601316	Blue



### STEEL CABLE GRAB

Only For Use on 3/8" Steel Cable

Designed for use on

3/8" diameter steel cable. Manufactured from steel for durability. Can be attached and removed from the cable at any point. Slight spring tension keeps the unit in the locked position unless upward pressure is applied to the pivot arm. Exceeds applicable OSHA/ANSI regulations.

**Weight:** 34 oz.

602700	Steel Cable Grab
--------	------------------



### CMI 8 DESCENDERS

#### The Original Rescue 8

Cold forged design with durable hard-coat anodized finish. Rescue 8 has "ears" to aid in "locking-off."

**Color:** Charcoal

**Dimensions:** Large: 6.6" x 6" (16.8 x 15.2 cm); Small: 5.5" x 2.73"

**Size:** Large: 8 oz. (227 gm); Small: 4.8 oz. (136 gm)

**NFPA Rating:** General Use

Meets NFPA 1983/ANSI construction specifications for Descenders.

		Weight
601000N	Rescue 8	8 oz.
601001N	Regular 8	4.8 oz.



### RESCUE 9

A modified Rescue 8 Descender that features a rigging eye set at 90 degrees from the rescue 8. The rigging eye helps to properly position the unit, without twisting, when attached to the harness. Top pin allows for additional friction and a easier lock-off. Anodized forged aluminum construction.

**Rating:** General Use **Weight:** 7 oz. (195 gm)

**Rope diameter:** 5/16" - 1/2" (9 - 13mm)

**MBS:** 7,868 lbf. (35 kN)

	Color
60114201	Black



## WARNING

**CAUTION:** Care must be taken when using the Steel Rescue 8 to rappel, belay, or lower personnel or heavy loads. Steel does not provide as much friction as aluminum figure 8's of similar design and size. *Technical rescue and safety is potentially hazardous. Any person using equipment sold by RESCUE TECHNOLOGY in any manner is personally responsible for learning the proper techniques involved, and assumes all risks and accepts full and complete responsibility for any and all damages or injury of any kind, including death, which may result from the use of any RESCUE TECHNOLOGY equipment.*





### MAGNUM RIGGING PLATE



Large size and 15 holes to accommodate multiple rigging needs. Manufactured of alloy aluminum.

**Strength:** 12,365 lbf. (55 kN) **WLL:** 1,236 lbs. (562 kg)

**Length:** 9.75" (249mm) **Width:** 5.875" (150mm)

**Hole Size:** 3/4" (19mm) **Weight:** 16 oz. (471gm)

**NFPA Rating:** General Use

603216 Magnum Rigging Plate



### TECHNICAL RESCUE RIGGING PLATE



A standard size multi-hole rigging plate. Manufactured of alloy aluminum.

**Strength:** 12,365 lbf. (55 kN) **WLL:** 1,236 lbs. (562 kg)

**Length:** 6.25" (165.6mm) **Width:** 3.75" (108mm)

**Hole Size:** 3/4" (19mm) **Weight:** 8 oz. (262gm)

**NFPA Rating:** General Use

603215 Technical Rigging Plate



### MICRO RIGGING PLATE



The smallest rigging plate in the Rescue Technology line. Made from 1/4" alloy aluminum plate, the Micro Rigging Plate is both strong and lightweight. Ideal for Search and Rescue, Climbing, and Litter Bridles.

**Strength:** 8,094 lbf (36 kN) **WLL:** 800 lbs (364 kg)

**Length:** 3.5" (87.5mm) **Width:** 3.25" (81mm)

**Hole Size:** 3/4" (19mm) **Weight:** 2.4 oz. (68.2 gm)

**NFPA Rating:** General Use

603214 Micro Rigging Plate



### STAINLESS STEEL RIGGING PLATE



*Heavy Duty / Lightweight*

Designed to compliment your existing rigging equipment. Lightweight, strong and effective. Allows rigging team to set up more efficient anchor systems. Prevents carabiners from jamming together. Machined from stainless steel.

**Strength:** 13,000 lbf. (57.8 kN) **WLL:** 1,300 lbs. (590 kg)

**Dimensions:** 5 x 5" (125 x 125mm) **Weight:** 12 oz. (68.2 gm)

**NFPA Rating:** General Use

603211 Stainless Steel



### INSTANT HITCH ANCHOR

*Fits Vehicle Receiver Hitch*

A simple solution to a basic problem. How do you use your vehicle as an effective anchor? The IA does this by transforming a receiver hitch into a multi-point technical rescue anchor. Durable steel construction with electrostatic powder painted finish.

**Strength:** 8,993 lbf. (40 kN) **WLL:** 900 lbs. (409 kg)

**Dimensions:** 13.25 x 8.5" (331 x 213mm) **Weight:** 8.1 lbs.

**NFPA Rating:** General Use

Must be used with a properly, professionally installed Class III receiver hitch with appropriate hitch pin (not included) installed and secured.

603415 Instant Hitch Anchor



### ROCK EXOTICA UNIVERSAL FOCUSING OBJECT (UFO)

*Universal Focusing Object*

A new generation of rigging plate allowing you to position in three dimensions.

**Weight:** 16 oz (470 gm) **Height/Width:** 3.5" (89 mm)

**Breaking Strength:** 8093 lbf. (36 kN)

Color

243818210 Universal Focusing Object Charcoal



Actuated Girder Grip ready for insertion



## ISC GIRDER GRIP

For Steel Work

Anchor designed to provide secure anchor points through steel structure. Fits hole size: 19 - 28mm. Manufactured of high tensile strength steel and aluminum.

**Minimum strength:** 6,000 lbf. **Weight:** 20 oz.

603110 Girder Grip

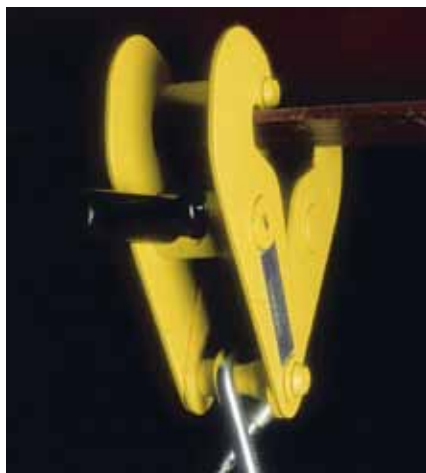

## BEAM CLAMP

Designed as a high strength portable rigging point for both horizontal and vertical I-Beam structures. The turnbuckle type threaded mechanism allows quick attachment to 3" - 9" flange widths. Every unit is tested and certified before shipment.

**WLL, Personnel:** 2,000 lbs. (909 kg) **Weight:** 11.3 lbs. (5.1 kg)

**WLL, Equipment:** 4,000 lbs. (1818 kg) **NFPA Rating:** General Use

603412 Heavy Duty Beam Clamp



## SNOW/SAND PICKET

Custom "Anchor" shaped structural aluminum alloy pickets in two lengths. Multiple rigging holes for ease of use. No sharp edges. Powder coated for durable good looks.

603136 36" Picket



## RIGGING RINGS

Traditional forged rings to be used as rigging rings, connection points for rigging a stretcher, and many other uses. Drop forged alloy steel.

**Inside Diameter:** 3 inches **Rating:** General Use.

		Strength	Weight
603230	1/2" Ring	10,000 lbf.	10.4 oz.
603240	9/16" Ring	40,000 lbf.	12 oz.



## FORGED ANCHORAGE CONNECTOR I

With Threaded Stud

Drop forged alloy steel. Meets or exceeds ANSI Z359.1 and CSA Z259.12-00. Complete with grade 9 nut and lock washer.

**Recommended torque value:** 45 - 55 ft.-lbs. **Bolt diameter:** 1/2"

603105 Anchor Connector I



Retrieval Hook

## REMOTE RETRIEVAL HOOK

Hold-Tite Pole Adapter Holds Hook

A Retrieval Hook that allows the attachment of a retrieval line to an entrant without entering the confined space. The Remote Retrieval Hook is held open so the rescuer can connect it to a harness D ring. As soon as the snap is engaged a simple tug will lock the Hook to the harness. Sling may be attached to end of retrieval line for victim rescue. Comes complete with auto-locking snap and nylon sling. Extension Pole with Hook Adapter sold separately. Hook Materials: Stainless Steel w/ protective plastic shroud.

**Gate Opening:** .75" **Hook Strength:** 5,000 lbs.

Remote Retrieval Hook and Pole sold separately.

		Height
616101	Retrieval Hook w/ Sling	
616112	Extension Pole	6' - 12'
616124	Extension Pole	8' - 24'
616200	Storage Bag	6' - 12'
616210	Storage Bag	8' - 24'



Set includes 2 TRC Pickets and 1 Windlass

## TRC SUPER DUTY PICKET SET



Designed to give the strongest picket placement. Features 10" x 7.25" rigging fins that stabilize the pickets with more lateral surface area than standard round pickets. Each picket has 8 holes (.75" dia.) to aid in system rigging. Multiple rigging options. Made from 1" cold rolled steel. Includes 2 TRC Pickets and 1 Windlass (.75" diameter)

Optional padded storage bag.

**Picket Length:** 48" **Picket Weight:** 16 lbs. each

**Windlass Length:** 36" **Weight:** 4.6 lbs.

603204 TRC Picket Set  
603202 Picket Storage Pack

# RESCUETECH KITS

## EVERYTHING YOU NEED

RescueTECH offers a great selection of Rescue Kits and Rescue Equipment Sets for Technical Rope Rescue, High Angle Rescue, Confined Space Rescue, Tower Rescue, First Responder Rope Rescue and First Responder Water Rescue. All of our kits are made with the most current model of the components. As such, many kits are made-to-order and may require a couple of days to assemble.

### DELUXE TEAM MEMBER SET

With RescueTECH Rappel/Rescue Rack

- VANGUARD II Rescue Harness (1) • R5SL Rescue Helmet (1) • Pixa2 Headlamp (1) • Knee Pads (1 pair) • Uniform Emergency Belt (1) • Presewn Prusik Sling, 20" (1) • Presewn Prusik Sling, 30" (1)
- Rescue/Rappel Rack (1) • Cyalume Lightstick (White) (3) • Pro Leather gloves (1) • Glove Cinch (1) • 1 in. Orange HD Web, 20 ft. (1) • Technical Rescue Field Guide (1) • 1/2" Access Lifeline (10') (1)
- Zorber Shock Absorber (1) • Transfer Sling (1) • Adjustable Rigging Sling (1) • RD70™ Rescue Carabiners (5) • Rescue Gear Bag (1) Items shown for illustration purposes - Not to Scale. Items subject to change if new/improved components become available.



29982191

Deluxe Team Member Set

### DELUXE TEAM MEMBER SET I'D

With with Petzl I'd

Same item list as 2998291 but with the substitution of a Petzl I'd for the rack descender.

- VANGUARD II Rescue Harness (1) • R5SL NPFA Helmet (1) • Pixa 2 Headlamp (1) • Knee Pads, Pair (1) • RescueTECH Uniform Belt (1) • Presewn Prusik Sling 30" (1) • Presewn Prusik Sling 20" (1)
- RD70™ Rescue Carabiners (5) • Pro Leather gloves (1) • Glove Cinch (1) • Petzl I'D (1) • Technical Rescue Field Guide (1) • Rescuer Gear Bag (1) • Shock Absorber (1) • Transfer Sling (1) • Adjustable Rigging Sling (1) • 1 in. Orange HD Web, 20 ft. (1) Items shown for illustration purposes - Not to Scale. Items subject to change if new/improved components become available.



29982192

Deluxe Team Member Set I'D



## ROPE ACCESS TECHNICIAN EQUIPMENT SET

A simple set of personal equipment for basic Rope Access work.

- Advantage Full body Harness (1) • Vertex 2 Vent Helmet (Red) (1) • 10mm Delta Rapid Link (1) • ISC D4 (1) • Micro Strap Pulley (1) • Adjustable Foot Sling (2) • ISC RED Backup Device (2) • T2 Rescue Pack (1) • Chest Ascender (1) • Pro Leather Glove (Tan) (1 pair) • "I" Lanyard, 24" (1) • "I" Lanyard, 32" (1) • Handled Ascender (1) • Aluminum Offset D Carabiner (10) • 6mm Connector Link (2) • Chest Harness Ascender loop (1)

Items shown for illustration purposes - Not to Scale. Items subject to change if new/improved components become available.



29982013

Rope Access Technician Equipment Set

## TECHNICAL RESCUE TEAM MEMBER SET

The basic starter set for most team members.

- Vanguard II Full Body Harness (1) • Vertex 2 Vent (1) • Pro Leather Gloves (Black) (1 pair) • Prusik Sling, 30 in. (Red) (1) • Prusik Sling, 20 in. (Yellow) (1) • Daisy Chain, 36 in. (Red) (1) • Technical Rescue, Rope I & II (1) • Personal Gear Bag (BK/RD) (1) • Harness Equipment Pouch (1) • Striketeam XTO Goggles (1) • EOS Headlamp (1) • Rescue 8 (1) • OD50 Rescue Carabiner (3)

Items shown for illustration purposes - Not to Scale. Items subject to change if new/improved components become available.



29981011

Team Member Kit

## BASIC FIRST RESPONDER TEAM SET

The basic starter set for most team members.

- Prime Full Body Harness (2) • Vertex 2 Vent Helmet (2) • 12mm Delta Rapid Link (1) • Rescue 8 Descender (2) • Anchor Sling w/ 'D' (1) • Access Lifeline, 1/2 in. x 200 ft. (1) • H.D. Gear/Equipment Bag (1) • Rope Bag (1) • OD50 Rescue Carabiner (5) • Pro Leather Glove (2 pair)

Items shown for illustration purposes - Not to Scale. Items subject to change if new/improved components become available.



29981002

First Responder Set

## 2 RESCUER CONFINED SPACE STANDBY SET

The set is the minimum set of equipment needed to start a standby team and access the patient. Includes harness and personal safety equipment for 2 rescuers. • *Vanguard II Full Body Harness (2)* • *Vertex 2 Vent helmets (2)* • *Rope & Equipment Bags (2)* • *1/2 in. Access Lifeline x 150 ft. (2)* • *EOS Headlamp (2)* • *2.5 PMP Rescue Pulley (4)* • *Rescuer Gear Bag (2)* • *Presewn Prusik Sling 20" (2)* • *Presewn Prusik Sling 30" (2)* • *Pro Leather Gloves (2)* • *RescueTECH Load Release Strap (2)* • *OD50 Rescue Carabiner (10)* • *NFPA 'D' Screwgate (2)* Items shown for illustration purposes - Not to Scale. Items subject to change if new/improved components become available.



29981001 2 Rescuer Confined Space Standby Set

## TECHNICAL RESCUE TEAM SET

The minimum team equipment required to handle most high or low-angle rope rescue responses. Sufficient for rescues that require both raising and lowering of a patient.

• *Rescue Stretcher, S.S. (1)* • *Deluxe Rescue Etrier (1)* • *Stretcher Patient Harness (1)* • *Quick-Fit Lashing Kit (1)* • *Adjustable Bridle Kit (1)* • *Stretcher Equipment Pack (1)* • *Rope Bag (2)* • *Duffel Bag, XL (1)* • *Equipment Cache (1)* • *Anchor Sling w/ 'D', 6 ft. (2)* • *Anchor Sling w/ 'D', 8 ft. (2)* • *Transfer Sling (1)* • *Load Release Strap (2)* • *8mm Prusik x 5 ft. (6)* • *8mm Prusik x 6 ft. (1)* • *1/2 in. Rescue Ascender (2)* • *2.5 PMP Rescue Pulley (5)* • *RescueTECH Edge Roller, Double (1)* • *Rope Pad, Wide (1)* • *1 in. Yellow HD Web, 12 ft. (2)* • *1 in. Orange HD Web, 20 ft. (2)* • *Rigging Plate (1)* • *Delta Link (4)* • *NFPA Offset 'D' Carabiner (1)* • *NFPA 'D' Screwgate (3)* • *Rescue Rappel Rack (1)* • *RD70 Rescue Carabiner (15)* • *Rope Guard, Red (4)* • *1/2 inch. Access Lifeline x 150 ft. (2)*

Items shown for illustration purposes - Not to Scale. Items subject to change if new/improved components become available.



29982012 Technical Rescue Team Set



## USAR PACK RESCUE SET

An equipment set designed to provide equipment for basic rigging, access, and rescue. • **USAR Rope & Equipment Pack (1)** • **1/2 in. NFPA Rope (1)** • **NFPA Rescue 8 Descender (1)** • **RD70 Rescue Carabiner (8)** • **RescueTECH Anchor Sling, 8 ft. (2)** • **2.5 PMP Rescue Pulley (2)** • **Gibbs Ascender, Free Running (2)** • **1/2 in. Rescue Ascender (1)** • **Rescue Rappel Rack (1)** • **Anchor Sling w/ D, 6 ft. (2)** • **2 in. RescueTECH PMP Bushing Pulley (1)** • **Rope Guard, 18 in. (2)** Items shown for illustration purposes - Not to Scale. Items subject to change if new/improved components become available.



## RAISE / LOWER SET

Equipment set-up popular at many state fire/rescue academies. Sufficient for a Z-Rig Raise and Rack Lower System. • **Equipment Saddle Bag (1)** • **NFPA Rescue Rope (1)** • **Anchor Sling w/ D, 10 ft. (2)** • **8mm Cord x 5 ft. (2)** • **8mm Cord x 6 ft. (1)** • **Rescue Rappel Rack (1)** • **Rope Bag (1)** • **Rigging Plate (1)** • **PMP Rescue Pulley (2)** • **RD70 Rescue Carabiner (5)** • **Dogbone Rigging Sling (1)** Items shown for illustration purposes - Not to Scale. Items subject to change if new/improved components become available. \*Meets NFPA 1983/ANSI/OSHA strength specifications.



## Z-RIG HAUL SET

RescueTECH equipment packaged in a ready-to-rig 3:1 Z-Rig system. • **Rope Bag (1)** • **Anchor Sling w/ D (6') (1)** • **2.5 PMP Rescue Pulley (2)** • **OD50 NFPA Rescue Carabiner (3)** • **Blue HD Web, 15 ft. (1)** • **Delta Rapid Link (1)** • **1/2 in. Rescue Ascender (1)** • **8mm Cord x 5 ft. (1)** • **8mm Cord x 6 ft. (1)** • **1/2 in. NFPA Rope x 200 ft. (1)** Items shown for illustration purposes - Not to Scale. Items subject to change if new/improved components become available.



## GF-USAR RESCUE PACK SET

RescueTECH equipment packaged in a ready-to-rig 3:1 Z-Rig system. • **Rope Bag (1)** • **8mm Cord x 6 ft. (4)** • **1/2" Rescue Ascender (1)** • **Delta Rapid Link (2)** • **Rescue Rappel Rack (1)** • **8mm Cord x 5 ft. (4)** • **1 in. Green HD Web, 5 ft. (2)** • **1 in. Yellow HD Web, 12 ft. (2)** • **1 in. Orange HD Web, 20 ft. (2)** • **1 in. Blue HD Web, 15 ft. (1)** • **OD50 Rescue Carabiner (10)** • **NFPA Rescue 8 Descender (1)** • **540 Belay Device (1)** • **XL Rescue 'D' Carabiner (1)** Items shown for illustration purposes - Not to Scale. Items subject to change if new/improved components become available.



91231001

GF-USAR Rescue Pack Set



## USAR PACK DELUXE RESCUE SET

An equipment set designed to provide equipment for basic rigging, access, and rescue. • 1/2" NFA Rope x 200 ft. (1) • RescueTECH Large D Carabiner (12) • Gibbs Ascender, Free Running (2) • 1/2" Rescue Ascender (2) • NFA Rescue 8 Descender (1) • Rescue Rack (1) • Anchor Sling w/ D, 6 foot (4) • 2.5 PMP Rescue Pulley (4) • 1 2.5" Double PMP Rescue Pulley (1) • 2 Rope Guard, 18" (2) • Delta Rapid Link (1) • Technical Rescue Rigging Plate (1) • 10" Steel Cable Sling (1) • Red HD Web, 25 ft. (2) • Orange HD Web, 20 ft. (2) • Blue HD Web, 15 ft. (2) • Yellow HD Web, 12 ft. (2) • Green HD Web, 5 ft. (2) • 8mm Prusik Cord, Long (4) • 8mm Prusik Cord, Short (4) • USAR Pack (1)

Items shown for illustration purposes - Not to Scale. Items subject to change if new/improved components become available.



	Color
350566	Blue
350564	Red

## DELUXE EQUIPMENT PACK SET

A set of equipment designed to meet the basic needs of rescuers. Use this set of equipment with two life safety ropes and create a raise / lower system with belay system. Multiple mechanical advantage systems can be built as well as specialized rigging systems. • Deluxe Equipment Pack (1) • 8mm Prusik x 6' (2) • Rescue Rappel Rack (1) • Aluminum D, S/G (1) • Delta Rapid Link (1) • RD70 Carabiner, S/G (10) • 2.5" Single PMP (3) • 2.5" Double PMP (3) • Rope Guard, 18" (2) • Anchor Sling, 8' (2) • Anchor Sling w/ D, 6' (2) • 1" H.D. Web x 20' (2) • 1" H.D. Web x 25' (1) • Load Release Strap (1) Items shown for illustration purposes - Not to Scale. Items subject to change if new/improved components become available.



29983420

Deluxe Equipment Pack

## CONFINED SPACE RESCUE SET

Designed to provide a 2-person team with a set of equipment that allows for the rescue of victims. Comes complete with Tripod and Extractor CSR Kit for an anchor point and retrieval system. A separate belay may be set up with the included Petzl I'd Belay device and 150 ft. section of 1/2" ACCESS Lifeline. Rigging equipment and edge protection is also included. All personal and team equipment, as well as hardware and tripod storage is included. • **EOS Headlamp (2)** • **Vertex Vent Helmets (2)** • **Pro Leather Glove (pair) (2)** • **Vanguard II Rescue Harness (2)** • **Technician Tripod w/ Tripod Bag (1)** • **Petzl I'D Belay Device (1)** • **1/2" ACCESS Lifeline x 150 ft. (Blue) (1)** • **Technical Rescue Rigging Plate (1)** • **OD50 Steel Carabiners, Screwgate (10)** • **RescueTECH PMP, Bushing (1)** • **1/2" Extractor CSR Kit w/ Bag, 150 ft. (1)** • **Rigging Sling w/ D, 8 ft. (2)** • **Load Release Sling (1)** • **11mm Aluminum Carabiner, Screwgate (1)** • **Remote Retrieval Hook (1)** • **Extractor Pole, 12' (1)** • **RescueTECH Edge Pad, Wide (1)** • **RescueTECH Rope Guard, 24" (Red) (2)** • **RescueTECH Rope Bag, Medium (Blue) (1)** • **RescueTECH Deluxe Equipment Pack (Blue) (1)** • **RescueTECH Duffle Bag, Large (Blue) (2)** Items shown for illustration purposes - Not to Scale. Items subject to change if new/improved components become available.



2998123

Confined Space Rescue Set

## SPIN-LOCK RESCUE / RETRIEVAL SYSTEM

### Locking Pulley for Combination Raise / Lower System

The Spin-Lock Rescue system is a pre-rigged 4:1 Hauling system that utilizes a unique pulley with sheaves that rotate in only one direction. When properly rigged, this system works as an efficient 4:1 mechanical advantage pulley system that also provides friction to control the load when in lowering mode. The special sheave are mounted on a unique one-way bearing that allows the user to easily control a rescue load. Also, included is a Handled Ascender to control and anchor the system when at rest. The attached foot loop also aids the rescue in raising heavier loads. The Spin-Lock Rescue / Retrieval Kit is a pre-rigged kit that combines the RescueTECH Remote Retrieval Hook and Extension Pole access system with a Spin-Lock Rescue / Retrieval system. The remote hook and extension pole allows for non-entry remote attachment of a rescue lifeline to a victim in a confined space or vertical environment.

Item	Description/Length	Item	Description/Length
29984401	Spin-Lock System / 50'	29984421	Spin-Lock Kit / 50'
29984402	Spin-Lock System / 75'	29984422	Spin-Lock Kit / 75'
29984403	Spin-Lock System / 150'	29984423	Spin-Lock Kit / 150'



Remote Retrieval Hook and Extension Pole included in Kit ONLY



## EXTRACTOR™ CONFINED SPACE RESCUE KIT

### Confined Space Personnel Rescue Kit

**FOR RESCUE:** Used as 4:1 Block and Tackle or “piggy-backed” onto main haul line. Decreases training needs for mechanical advantage systems. Great re-direct pulley with a built-in safety. No loss of haul due to slack in a prusik cord or external camming safety. **FOR INDUSTRY:** Easy to use. Meets OSHA 1910.146 Mechanical Retrieval Device standard. Meets ANSI Z359.1 vertical lifeline standards and autolocking carabiner requirements. **LIFTING SAFETY:** Unit works as a hauling system with a “deadman’s” safety. Included safety pin holds cam in either open (rope will run freely in both directions) or in safety position. Rope will move in hauling direction only and cannot be removed or fall out when safety is engaged. Extractor™ may be used horizontally and can be attached to a haul-line to act as a 4:1 hauling system. 1/2” version available in 37 ft., 50 ft. and 66 ft. lift capacity. 7/16” version available in 50 ft. and 100 ft. lift capacity. **REMOTE LOWERING CAPABILITY:** The attached cable allows remote control of the safety cam. This makes it possible to place the Extractor™ unit where it cannot be directly accessed. Extractor™ design provides over 135° of hauling line movement. It does not limit hauling team to standing “in-line” with the rope system. The pulley sheaves are equipped with Oillite™ bushings and will accept ropes up to 1/2” diameter. The Extractor™ frame is constructed of high tensile aluminum alloy. **WLL:** 1,000 lbs.

**Dimensions:** 9” x 3” **Color:** Red

**All Kits include:** • ACCESS Lifeline w/ sewn eye (1) • EXTRACTOR™ CSR Pulley (1) • Double or Single Pulley (1) • Autolocking Carabiners (1) • Rope and Equipment Bag (1)

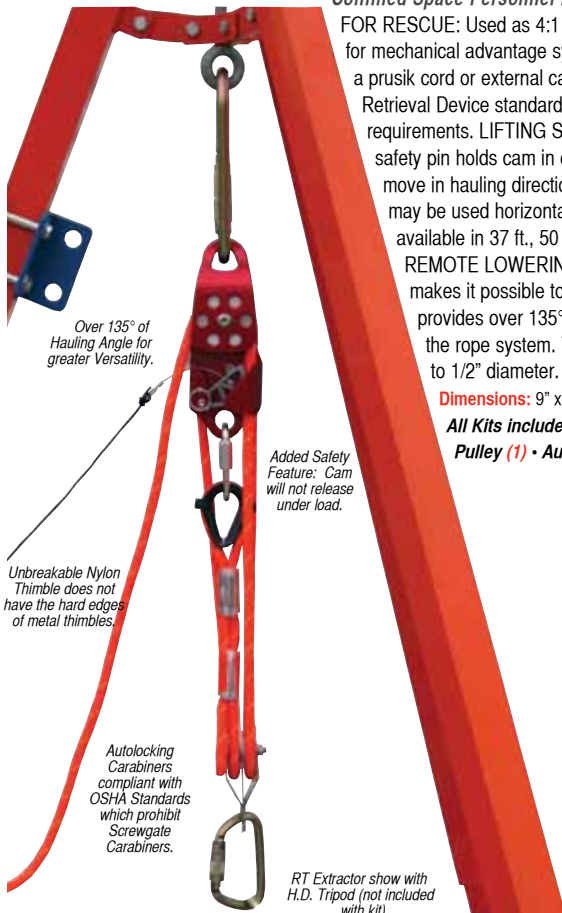

RT Extractor show with H.D. Tripod (not included with kit)



### 4:1 / 5:1 EXTRACTOR™ LOAD TRANSFER KIT

This kit is a mechanical advantage system that allows the user to safely transfer a load. It provides the security of a built-in safety cam. 4:1 Kit complete with 40 feet of rope for 10' of lift. Available with Autolocking or Screwgate carabiners.

Meets NFPA 1983/ANSI/OSHA strength requirements.

	Length
614422	Autolock
614425	Screwgate

### 4:1 HAULING KIT

#### Block and Tackle System

Complete hauling kits that are ready to use. Each kit contains 1/2” Rescue rope & prusik cord, high strength pulleys, Gibbs Ascenders and RescueTECH Carabiners complete the system. 4:1 Block and Tackle pulley system is packaged in Rope and Equipment Bag, and is ready for the rescuer to simply reach in and grab the carabiner to attach to the rigging point.

Meets NFPA 1983/ANSI/OSHA strength specifications.

	Length
610604	150'
610624	200'

### 1/2” EXTRACTOR™ CSR KIT

#### With Rope / Equipment Bag

614481200xx	4:1 Extractor Kit x 200'
614481150xx	4:1 Extractor Kit x 150'
614482200xx	4:1 Extractor Swivel Kit x 200'
614482150xx	4:1 Extractor Swivel Kit x 150'
614381200xx	3:1 Extractor Kit x 200'
614381150xx	3:1 Extractor Kit x 150'

### 7/16” EXTRACTOR™ CSR KIT

#### With Rope / Equipment Bag

614471200xx	4:1 Extractor Kit x 200'
614472200xx	4:1 Extractor Swivel Kit x 200'
614371200xx	3:1 Extractor Kit x 200'
614371300xx	3:1 Extractor Kit x 300'

Extractor Kit with Bag.



Swivel Kits complete with lower swivel pulley.

## TOWER RESCUE SYSTEM II

A Rescue Technology original. Specially designed pack protects contents and allows a rescuer to comfortably carry the pack up to the point of rescue. Packaged in a RescueTECH T2 Rescue Pack. The system is comprised of a load transfer system that allows the rescuer to move the patient onto the rescue system without having to cut away existing fall restraint. The load is then lowered using Anthon Lowering device. Features Certified NFPA 3/8” Rescue rope.

• 3/8” ACCESS Lifeline x 300

ft. (1) • RescueTECH Rigging Sling, 4 ft. (1) • CSR Load Transfer System (1) • Anthon Lowering Device (1) • T2 Rescue pack (1) • AutoLocking Carabiners (3)





# SLINGS & LANYARDS

## SUPERIOR WEBBING

### RescueTECH Slings and Lanyards outperform the competition

RescueTECH webbing and rope slings are engineered to be stronger and outwear similar brands of straps. We have chosen higher strength webbing that gives better performance and adds to the trust that you can have in your systems. From our Heavy Duty Anchor slings that use a 10,000 lbf webbing with wear indicators to our Super Duty Anchor Slings, you can trust RescueTECH slings for all of your rescue needs.



### HEAVY DUTY ANCHOR SLING W/ WIDE "D" RING

Manufactured from heavy duty TECHWeb flat webbing (Tensile Strength: 10,000 lbf.). Each sling has a standard "D" ring (proof Load: 5,000 lbf.) and a Wide "D" sewn at the ends to provide maximum versatility. Anchor points may be wrapped single, double, triple, and rigged choker-style to suit particular rescue situations. Although webbing tensile strength is high, overall tensile strength is limited by the "D" rings.

**NFPA Tensile Strength (Basket):** 15,760 lbf. (70.1kN)

**Choker Strength:** 7,240 lbf. (32.2kN) **Color:** Yellow

**End-to-End Strength:** 8,660 lbf. (38.5kN) **Rating:** General Use

	Length
75941032	3'
75941042	4'
75941052	5'
75941062	6'
75941082	8'
75941102	10'
75941152	15'



### SUPER DUTY ANCHOR SLING

*Strongest Webbing Slings in the Rescue Industry*

Manufactured from 2" wide solid weave high strength webbing. Special RED internal tracers function as edge cut indicators that are exposed when the webbing edge is abraded, cut, or torn. Large heavy duty forged steel links on each end will allow end-to-end, basket, and choker use of the sling. Exceed all standards for two person lifeline strengths.

**End-to-End Tensile Strength:** 15,000 lbf **Color:** Yellow

**Basket Strength:** 28,000 lbf (125 kN) **WLL:** 1,500 lbs.

**Rating:** General Use

	Length
756504	4'
756506	6'
756508	8'
756510	10'



### HEAVY DUTY ANCHOR SLING

*Strongest 1" Heavy Duty Double End Rigging Sling*

Eliminates wasted rigging time spent tying knots in rigging lines. Made from 1" solid weave, high strength nylon webbing. The special webbing has RED tracers to indicate cuts in the webbing. Available in multiple lengths, each sling has a sewn loop at each end to provide maximum versatility. Anchor points may be wrapped single, double, triple, etc., to suit particular rescue situations. Anchor Slings exceed all standards and regulations for Light Use Life Support lines. When looped like a basket hitch, anchor slings meet General Use load requirements.

**End-to-End Tensile Strength:** 8,500 lbf. **Color:** Yellow

**Basket Strength:** 15,000 lbf. (67 kN) **WLL:** 850 lbs.

**Rating:** General Use

	Length
7550032	3'
7550042	4'
7550052	5'
7550062	6'
7550082	8'
7550102	10'



### QUIK-RIG HD

New quick-attach rigging point that eliminate off-axis loading of rigging carabiners. Simply wrap the sling around the rigging point to form a basket, then attach the Forged Eye Autolocking Steel Carabiner to the Rigging ring. Not designed for Choker attachment.

**Ring Strength:** 10,000 lbf. (44.5 kN)

**Carabiner Strength:** 10,000 lbf. (44.5 kN)

**Sling Strength when rigged into Rigging**

**Ring:** 10,000 lbf. (44.5kN)

75952044

75952064

75952084



### RESCUE SYSTEM CHANGE-OVER SLINGS

*Great Addition To Pre-Rig Systems*

Allows rescuers to extend a Z-rig past the lowering device without having to tie a "green" sling.

**Super Strong:** 8,500 lbf. **WLL:** 850 lbs.



753105 Dogbone Z-Rig Sling, 16"

7531052 Dogbone Z-Rig Sling, 21"



### RESCUE SYSTEM CHANGE OVER SLING W/ "D"

*Change-Over Sling w/ "D" Great Addition To Pre-Rig Systems*

Allows rescuers to extend a Z-rig past the lowering device without having to tie a "green" sling.

**Super Strong:** 16,000 lbf. **Weight:** 28 oz.

753106

Super H.D. Z-Rig Sling



## SUPERCLIP RESCUE TOOL

### Extend Rescuers' Reach

Superclip Rescue is designed for remotely holding autolock carabiners in the open position. Great for confined space rescue situations. Holds most Autolocking 3 Stage Carabiners. Pole kits include Superclip Rescue Tool, 3-Section Pole, and Supersafe 3-stage ANSI carabiner w/ sling. 4-12' Kit collapses to easily fit into most standard compartments.

**Weight, Clip:** 1.6 oz.

2462002	Super Clip (only)
2462112	4 - 12' Pole Kit w/ Carabiner/Sling

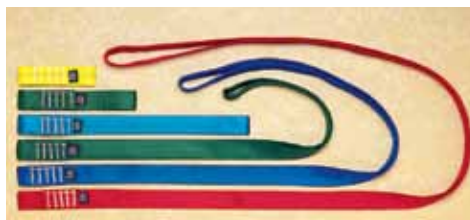

## STANDARD RESCUE LOOP

### High Strength Continuous Loop

High strength 1" Tubular Webbing (4,500 lbf.) provides a high strength loop. Because of the high strength and abrasion resistance of the Rescue-Spec™ Tubular webbing RescueTECH Standard Rescue Loops will outlast conventional tubular webbing slings.

**End-to-End Strength:** 7,400 lbf. **WLL:** 740 lbs.

**Colors:** Assorted

	Length
7612012	12"
7612024	24"
7612036	36"
7612048	48"
7612060	60"



## HEAVY DUTY ANCHOR LOOP

### Heavy Duty Continuous Loop

Constructed of same heavy duty webbing as the Anchor Sling. This unit is sewn to form a continuous high strength rigging loop. Items are sold by linear measurement of the loop laid flat. Anchor Loops meet all standards and regulations for two-person life support lines.

**End-to-End Tensile Strength:** 13,000 lbf. **WLL:** 1,300 lbs.

**Color:** Yellow **Rating:** General Use

	Length
7540042	4'
7540062	6'
7540082	8'
7540102	10'



## RESCUE ANCHOR SET

We have packaged two of our Heavy Duty Anchor Straps with a Wear Guard and Delta Rapid Link to give rescuers a quick, secure, and hard wearing anchor sling set. Includes storage bag.

	Size	Length
29982101	Large	8'
29982102	Medium	6'



## RESCUETECH MULTI-PURPOSE RESCUE STRAP

15' strap with forged adjuster buckle. Multiple uses: emergency harness, litter strap, rigging sling. Webbing

**Strength:** 6,000 lbf. **Buckle Proof Load:** 2,500 lbf.

**WLL:** 600 lbs. **Weight:** 10 oz.

**Color:** Black

756128	Multi-Purpose Strap
--------	---------------------



## SCREAMER LOAD LIMITER

Multi-functional energy absorbing device. Exceptionally good for use in anchor point protection in any raising or lowering system. The load limiters not only absorb energy when a system is overloaded but they act as a very reliable rescue system overload indicator. The load limiters can be "ganged" to accommodate various activation forces (550, 950, 1200 lbf.).

**Activation point is consistently repeatable to +/- 7%.**

**Activation Point:** 550 lbs Standard **Weight:** 2.4 oz.

753400	Standard Duty
--------	---------------



## RESCUE SHOCK ABSORBER

This is the highly efficient webbing tear-stitch type shock absorber utilized on our lanyards. The Zorber absorbs energy by means of a controlled destruction. Two layers of webbing are woven together. Limits OSHA style loads to a maximum force of 900 lbf.

**Initial Length:** 10" **Extended Length:** 52"

**Minimum Tensile Strength:** 6,000 lbf.

Meets all ANSI, OSHA standards and CSA construction requirements.

		Weight
A. 753420	Loop & Loop	8.8 oz.
B. 753424	Loop & Snap	15 oz.
C. 753426	Snap & D Ring	28 oz.





Includes Storage Keeper



### TRANSFER SLING

*Ideal for Rescue Pick-Off*

Manufactured with heavy duty TECHWeb 1 3/4" flat webbing and has a forged "D" ring sewn in one end and an adjustable "V" ring on the other end. Adjusts by pulling on the hand loop. The "V" ring adjuster buckle slips at 4,500 lbf. Hardware Proof Load: 2,500 lbf.

**Weight:** 14.4 oz. **Length:** 10' - 54"

**Rating:** General Use

756103

Transfer Sling



Includes Storage Keeper



### 2:1 PICK OFF STRAP

*Built-in Mechanical Advantage*

Used for patient pick-off situations. Configuration allows for 2:1 and 3:1 mechanical advantage for easier handling of loads. Materials: 1 3/4" Heavy Duty TECHWeb webbing with Forged D-Ring and Adjuster Buckles.

**Strength:** 7,000 lbf. **Weight:** 20 oz.

756104

2:1 Pickoff Strap



### QUIK-PIK STRAP

An updated version of our 2:1 pick-off strap. We have added an aluminum autolocking snap to the patient end of the unit allowing for rapid attachment and adjustment of the unit. Strap design provides mechanical advantage and will help lift load.

**Strength:** 5,000 lbf.

75610434

Quik-Pik Strap



### ADJUSTABLE RIGGING SLING

*With Heavy Duty TECHWeb*

An adjustable length rigging sling. Manufactured of heavy duty TECHWeb 1 3/4" flat webbing and has a forged "D" ring at each end. Adjusts with a slide adjuster.

**Webbing Strength:** 10,000 lbf. **Tensile Strength:** 8,000 lbf.

**WLL:** 800 lbs. **Length:** Adjustable

**Weight:** 24 oz. **Color:** Gold

	Length	Weight
756106	2' - 6'	24 oz.
756105	5' - 9'	29.6 oz.



### HEAVY DUTY LOAD RELEASE RESCUE STRAP

The Load Release Strap uses 15,000 lbf. Large rigging "D" Rings (3" x 2.55") and a standard 1.75" forged "D" on the adjustment part. 10,000 lbf. TECHWeb is used to provide superior strength and abrasion resistance over units using type 13 webbing. Designed to prevent the adjustment end of the webbing from sliding through the rigging "D" rings.

**Weight:** 23.2 oz.

756203

HD Load Release Strap

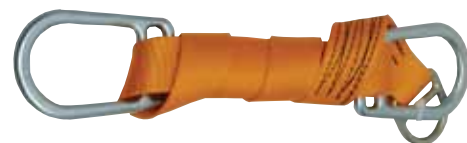

### LARGE RING LOAD RELEASE RIGGING STRAP

The Load Release Strap uses 15,000 lbf. Extra-large rigging "D" Rings (5" x 3.35") and a standard 1.75" forged "D" on the adjustment part. 10,000 lbf. TECHWeb is used to provide superior strength and abrasion resistance over units using type 13 webbing. Designed to prevent the adjustment end of the webbing from sliding through the rigging "D" rings.

**Weight:** 34.4 oz.

756202

Large Ring Load Release Strap





### WEBBING LANYARDS

Manufactured from heavy duty 1" wide nylon webbing and two double locking snaps at each end. New labeling and easier to use autolocking snap.

**Minimum Tensile Strength:** 5,000 lbf.

Meets all ANSI, OSHA standards and CSA construction requirements.

	Length
752042	2'
752043	3'
752044	4'
752046	6'



### WEBBING LANYARDS WITH LADDER HOOK

Manufactured from heavy duty 1" wide nylon webbing with a double locking snap at one end and a double locking ladder hook (2.5" gate opening) at the other end. Now available with integral shock absorber (Zorber™). New labeling.

**Minimum Tensile Strength:** 5,000 lbf.

Meets all ANSI, OSHA standards and CSA construction requirements.

		Length
752056	Snap / Hook (shown)	6'
752348	Adjustable, Snap / Hook	3'-6'
752346	Adjustable, Snap / Snap	3'-6'



### WEBBING LANYARDS WITH SHOCK ABSORBER

Lanyards that combine special shock absorber with one of the strongest webbings (10,000 lbf.) available. Webbing features cut indicators on each edge.

Meets all ANSI, OSHA standards and CSA construction requirements

	Length
753574	4'
753576	6'



Twin Leg Tower Lanyard, AutoLock

### TWIN LEG BYPASS LANYARDS

#### 100% Tie Off

Special design Lanyard with Zorber to be used for 100% tie-off method of climbing safety. One end has a double-locking safety snap or rapid link that attaches to harnesses. The "Legs" of the lanyard are complete with large 2.50" opening double locking Ladder Hooks.

Meets all ANSI, OSHA standards and CSA construction requirements.

752265	AutoLock, Steel
752265A	AutoLock, Aluminum
752275	Aluminum with Rapid Link
752264	AutoLock with Shock Absorber



### SHOCK ABSORBING LANYARDS WITH LADDER HOOK

Manufactured from heavy duty 1" wide nylon webbing with a double locking snap at one end and a double locking ladder hook (2.5" gate opening) at the other end. Manufactured with integral shock absorber (Zorber™). Minimum Tensile Strength: 5,000 lbf.

Meets all ANSI, OSHA standards and CSA construction requirements.

		Length
752156	Snap / Hook / Zorber	6'



### ADJUSTABLE TOWER LANYARD W/ SHOCK ABSORBER

Ideal for Tower/Ladder operations.

The Tower Strap allows the firefighter enough length to complete ventilation or perform window rescues while remaining secured to the bucket or ladder. Used in conjunction with the Truck / Escape Belt or Ladderman's Class II Harness. Adjusts from 4 - 6 ft. and equipped with autolocking snap and ladder hook. Integral Zorber shock absorber limits forces in case of fall. Notice: This product must be protected from temperatures above 250 degrees Fahrenheit and direct flame impingement. (Use Fire Resistant Truck Lanyard if in doubt of heat resistant needs)

609015	Adjustable Tower Lanyard
--------	--------------------------



### LANYARD "I"

Made from super-durable 11mm kernmantle rope. Ideal for rope access technicians. Lengths are color-coded at the ends.

	Length	Color
7515171024WR	24 in.	Orange
7515171032WR	32 in.	Blue



### SITE

#### Work Positioning Lanyard

The work positioning lanyard with great handling makes your work safe and efficient. 11mm rope sewn-in unopenable version of LOCKER - rope clamp. Rope covered with tubular webbing to increase wear resistance. Parking cam for locking in required position.

	Length
238910112	78"
238910114	157"



### ACCESS LANYARD "V"

It is used for working at height, especially for self-protection when moving from one place to another. The middle loop is attached to the harness with carabiners and energy-absorbing device. Shrink tubing protects each seam. Lanyard V has to be used as a component of a fall arrest system. Available in white/red.

	Size	Leg 1	Leg 2
751531323WR	Medium	13"	23"
751534040WR	Large	40"	40"



### REACTOR 2 "Y"

#### Ideal for Rope Access

A Twin-Leg static kernmantle rope lanyard with and integrated webbing shock absorber. 1000 lbf. maximum impact force. Complete with Ladder Hooks with 2.25" gate opening.

**500 activation force**

**Minimum breaking strength:** 3,375 lbf.

2389441155	Reactor "Y", 62 in.
------------	---------------------

## WARNING

Technical rescue and safety is potentially hazardous. Any person using equipment sold by RESCUE TECHNOLOGY in any manner is personally responsible for learning the proper techniques involved, and assumes all risks and accepts full and complete responsibility for any and all damages or injury of any kind, including death, which may result from the use of any RESCUE TECHNOLOGY equipment.



### REACTOR 2 "I"

#### with Shock Absorber

A Single Leg static kernmantle rope lanyard with an integrated webbing shock absorber. Complete with 1 autolocking lanyard hook.

**1000 lbf maximum impact force**    **500 activation force**

**Minimum breaking strength:** 3375 lbf.

	Length
2389422155	Reactor "I" 62"



### ASCENDER SLING SET



Designed for use with handled ascenders to allow rescuer to climb back up a rope. Manufactured of high quality 1" nylon webbing (Tensile Strength: 6,000 lbf.). One sling attaches to a seat harness, the stirrup connects a second ascender to the right or left foot.

**Weight:** 7.2 oz./pair **Color:** Orange

	Size	Height
602300	Medium	up to 6'
602400	Large	over 6'



### DOUBLE FOOT SLING

For those time where a single foot loop will not work, the RescueTECH Double Foot Sling fits the need. A handy sling that, when used with a handled ascender, allows the rescuer to climb up a rope. Easily attaches to ascender with rapid link or girth hitch. Foot loops held open by special stiffener.

6024321	Double Foot Sling
60510106	Connector

*Ascenders,  
Rapid Links and  
Carabiners not  
included*

### DELUXE ASCENDER SLING SET

Can be configured for both Texas and "Frog" style ascending systems. Simply attach slings via rapid link or girth hitch to ascenders. Adjustable harness attachment slings give this set a wide size range. Manufactured of high quality 1" nylon webbing. Two slings attach to a seat/chest harness. The double foot loops connects a second ascender to the rescuers feet. Special adjuster for the foot loops help prevent loops from sliding off boots.



6024334	Deluxe Ascender
---------	-----------------



### ADJUSTABLE FOOT SLING

A handy sling that, when used with a handled ascender, allow the rescuer to climb up a rope. Easily attaches to ascender with rapid link (link not included). Adjustable length.

6024301	Adjustable Foot Sling
60510106	Connector



### STEEL CABLE SLING

The highest quality life support slings made from flexible 3/8" steel cable. Manufactured with Flemish eye splices with steel swages per OSHA/ANSI standards. Each unit is tagged with date of manufacture, size, and working load in tons. Steel slings are excellent in areas of extreme high/low temperatures, chemical exposure, and abrasion.

**Proof Tested:** 5,400 lbf. **WLL:** 2,700 lbf.

**Rating:** General Use

	Length
759304	4'
759306	6'
759310	10'
759315	15'

### RESCUETECH DAISY CHAIN



#### Strong Rigging Loops

Traditional multiple loop rigging sling with "directional" rigging loops for higher strength. Made from 1" Tubular Webbing. Loop strength of 1,500 lbf exceeds that of competing multi-loop straps.

**Ultimate Strength:** 6,800 lbs.

**Specify Color:** 36" Black or Red (9 pockets); 60" Black or Blue (17 pockets).

	Size	Length	Color
7581361	Medium	36"	Black
7581364	Medium	36"	Red
7581601	Large	60"	Black
7581606	Large	60"	Blue







### RESCUETECH WEBBING LADDER

The Webbing Ladder offers the simplicity of a traditional 1" etrier but with increased comfort. Built in spreader and individual stays in the steps insures that steps remain open without causing "foot pinching". Built-in wrist loop. 6 steps.

**WLL-Step:** 300 lbs.  
**WLL-Unit:** 600 lbs.

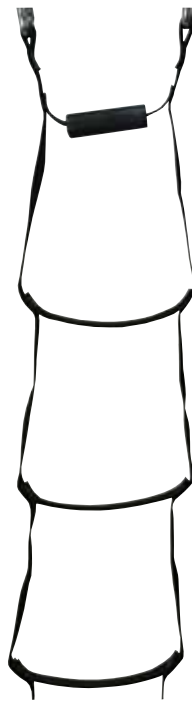

### RESCUETECH DELUXE WEBBING LADDER

**Multi-Unit Connect Ability**  
The Deluxe Webbing Ladder offers the features of our traditional 1" Webbing Ladder plus the ability to connect multiple units together. Built in spreader and individual semi-rigid stays keeps the steps open without causing "foot pinching". Multiple ladders may be linked together. 16 steps.

**WLL-Step:** 300 lbs.  
**WLL-Unit:** 600 lbs.



### RESCUETECH RESCUE ETRIER

A great help in rescue. Can be used as a simple step-up or at the breakover by safety personnel. Constructed of 1" flat webbing with a protective sheath at the carabiner rigging point for extra abrasion resistance. Double thickness of webbing keep steps open and hand loop at top.

**Tensile Strength:** 5,000 lbf.



758621

Height  
6'

758625

Height  
15'

		Color
758341	4 Step	Black
758342	4 Step	Yellow
758345	4 Step	Green
758361	6 Step	Black
758364	6 Step	Red
758366	6 Step	Blue



### RESCUETECH DELUXE RESCUE ETRIER

*Attached Rigging Sling*

A modified version of our popular 4 Step Rescue Etrier. We have attached a 24" length of versatile RT Daisy Chain Webbing.

**Tensile Strength:** 5,000 lbf.



758542  
758545

Color  
Yellow  
Green

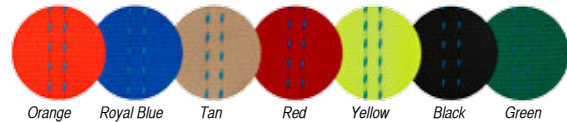

### RESCUETECH WEBBING

RescueTECH Rescue-Spec Tubular webbing is specially designed for the demands of rescue by exceeding the strength specifications of normal mil-spec webbing. Additionally, it will outwear any comparably sized tubular webbing. Special Lock-Stitch is used to make RescueTECH tubular webbing superior to all other tubular webbings - even mil-spec. For heavy duty rigging conditions, we recommend the use of our Rescue Technology Heavy Duty Flat Webbing. The Heavy Duty Webbing is more abrasion resistant than standard 1" tubular.

		Strength	Colors Available
7900	9/16" Tubular	2,299 lbf.	Black, Red, Royal Blue, Tan
7901	1" Tubular	4,200 lbf.	Black, Blue, Green, Orange, Red, Yellow, Purple, Tan
7902	2" Tubular	6,800 lbf.	Black, Blue, Red, Yellow
7945	1" Heavy Duty Flat	6,000 lbf.	Black, Blue, Green, Orange, Red, Yellow
7921	1.75" Heavy Duty Flat	6,000 lbf.	Black
7932	Seat Belt type Flat	6,000 lbf.	Black, Red

# arachnipod

TOTAL EDGE MANAGEMENT SYSTEM



The Arachnipod, in its most basic form, is a simple tripod with the three legs independently pivoting from an anodized aluminum head. The modular head has a similar design to a door hinge. Inserting or removing a pin through the center of the head allows the quick and simple addition or removal of components to create a configuration to suit any edge management scenario.

Configuration	Height	SWL*	Configuration	Height	SWL*
Gin Pole	6' 9"	600 lbs.	Tripod	8' 10"	880 lbs.
Gin Pole	10"	330 lbs.	Bridge-2 Meter	8' 10"	600 lbs.
A-Frame	8' 10"	600 lbs.	Bridge-3 Meter	8' 10"	500 lbs.
A-Frame	8'	750 lbs.	Bridge-4 Meter	8' 10"	385 lbs.
A-Frame w/ Lazy Leg	7' 6"	880 lbs.	Handrail Recovery Monopole**		600 lbs.

\* 10:1 Safety Factor with External anchor point

\*\* Dependent upon handrail rating

- A. Offset A-Frame
- B. Handrail Recovery Monopole
- C. Bipod
- D. High Directional Tripod w/ remote haul system
- E. Bridge System with controllable Trolley
- F. Gin Pole/Monopod
- G. Quadpod with Steps



## ARACHNIPOD MULTIPOD

*Intuitive Design - a Multipod for All Rescuers*

Innovative design that captures multi-functional capabilities. Simplicity and robust engineering provide the world's most versatile and strongest modular total edge management system (TEMS). The Arachnipod (APOD) is one height safety edge management device that can easily adjust into multiple configurations, providing users with a safe, effective total edge management system. The Arachnipod is based around the concept of an high strength tripod however this product is much more than just a tripod. NFPA testing and certification is underway and should be complete in 2013.

Components can be added or removed as required so that the APOD complements existing structural or natural features. The unique design of the patented modular head means the Arachnipod can be constructed into many different configurations including a gin pole/monopole, bipod, tripod, quadpod, bridge system and handrail recovery monopole.

The Arachnipod has been drop test rated for a 616 lbf. rescue load. It has a tested head that has the capability of holding a high directional load as well as

a belay system. The recommended rescue belay as tested with a 280 kg rescue load is the Traverse 540 ° Belay Device.

### Features:

- Easy set up
- Pins are secured to APOD with coated stainless steel cable.
- Leg stops will not allow lower portion to fall out of end.
- Rectangular Tubing and Large Pins mean less time to adjust
- 2 rigging swivel rings per basic tripod

### Ideal for:

- Rescue and emergency services
- Construction
- Military
- Utility services
- Mining
- Film industry
- Maintenance personnel

# MULTIPOD SYSTEMS

## PRE-BUILT KITS

Pre-built systems are ready for use upon delivery. These full systems are fully customizable with the addition of the Standard & Pulley Quadpod Add-On Kits and accessories. The components and accessories may vary from one kit to another. Please review each System's component list before placing your order.



Quad Plate\*



Lazy Leg Adaptor\*



Standard Leg

Lazy Leg\*

Pulley Leg\*



Gin Head\*



Rigging Plate\*



Arachnipod TEMS Manual

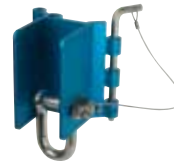

Reverse Head\*



Arachnipod TEMS Bag

\*Legs and accessories dependent upon multipod selection.

### ADVANTAGE-BASIC MULTIPOD

#### Standard legs with 2 Rigging Eyes

The Advantage-Basic model is the starting point for rescue and work use. Based on a traditional tripod design, the Advantage-Basic has 2 swivel rigging points underneath the "head". It is easily upgraded to a Quadpod choosing the appropriate Quadpod Add-on Kit.

Weight: 57 lbs.

#### Systems Built:

Tripod with 2 rigging points, Lazy Leg Tripod, Bipod/A-Frame, Lazy Leg A-Frame

#### Components Included:

- Standard Leg with Swivel Anchor (2) • Lazy Leg with Adaptor (1) • Feet Restraining Rope (1)
- Padded Storage Bag (1) • Manual (1)

24481105 Basic

### ADVANTAGE-BASIC PLUS MULTIPOD

The "PLUS" upgrade to the Advantage-Basic adds the necessary components to increase the capabilities of the already versatile Advantage-Basic Multipod. The system adds a Gin Head, Rigging and Quad Plate, and a Reverse Head to the Advantage Multipod system.

#### Systems Built:

Tripod with 2 rigging points, Offset A-Frame with standard rigging point, Lazy Leg Tripod, Gin/Monopole, Bipod/A-Frame, Lazy Leg A-Frame

#### Additional Components Included:

- (1) Rigging Plate • (1) Quad Plate • (1) Reverse Head • (1) Gin Head

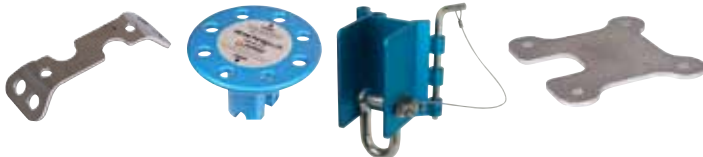

24481106 Basic Plus

### ADVANTAGE MULTIPOD

#### Pulley leg adds over-the-top Capability

The Advantage Multipod is a step up from the Basic Multipod. The exchange of a Pulley Leg for the Standard Leg gives rescuers over-the-top capability for rope and cable systems while retaining a swivel rigging point. It is easily upgraded to a Quadpod choosing the appropriate Quadpod Add-on Kit.

Weight: 60 lbs.

#### Systems Built:

Tripod with pulley head and 1 rigging point, Lazy Leg Tripod, Bipod/A-Frame, Lazy Leg A-Frame, Handrail monopole

#### Components Included:

- Pulley Leg (1) • Standard Leg with Swivel Anchor (1) • Lazy Leg with Adaptor (1)
- Feet Restraining Rope (1) • Padded Storage Bag (1) • Manual (1)

24481205 Advantage

### ADVANTAGE PLUS MULTIPOD

The "PLUS" systems are the premier multipod systems from Arachnipod. The upgraded component list increases the versatility and gives rescuers advanced capabilities. The system adds a Gin Head, Rigging and Quad Plate, and a Reverse Head to the Advantage Multipod system.

#### Systems Built:

Tripod with Pulley Head, Offset A-Frame with pulley high point, Lazy Leg Tripod, Gin/Monopole, Handrail Monopole, Bipod

#### Additional Components Included:

- (1) Rigging Plate • (1) Quad Plate • (1) Reverse Head • (1) Gin Head

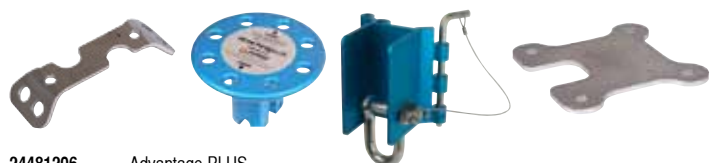

24481206 Advantage PLUS



# TOTAL EDGE MANAGEMENT SYSTEM



The Arachnipod Total Edge Management System (TEMS) is an innovative multipod system that captures the functional capabilities of the Arachnipod Multipod platform and turns it into a robust all-edge management system. At the heart of the TEMS is the Advantage Multipod. To this we add the Bridge Add-on and the Full Accessory kit. These features are unique to the Arachnipod TEMS. The Bridge is used to span larger openings or voids where a regular tripod or quadpod won't work. Complete with a trolley rigging point, the TEMS allows rescuers to hoist the patient then move him to the end of the bridge out of the way of the spanned void. Use of an English Reeve System further simplifies the rescue.

**The Arachnipod Total Edge Management System may be rigged as:**

*Gin Pole (monopole / monopod), A-Frame (Bipod), Lazy Leg A-Frame, Sideways/Offset A-Frame, Tripod, Quadpod, Lazy/Easel Leg Tripod Handrail Monopod Bridge*

**Items included in a kit:**

- (1) Arachnipod Advantage System • (1) Arachnipod 2 Meter Bridge Kit • (1) Arachnipod Reverse Head
- (1) Arachnipod Full Accessory Kit

24481301	2 Meter TEMS
24481303	3 Meter TEMS
24481304	4 Meter TEMS

## ADD-ON KITS QUADPOD

The following add-on kits function perfectly with the Advantage-Basic, Advantage, Advantage-Basic Plus, and Advantage Plus Multipod Systems. It is important to note that the aforementioned Systems must be purchased to utilize the Add-on kits. **(Bridge Kit Add-On page 68)**

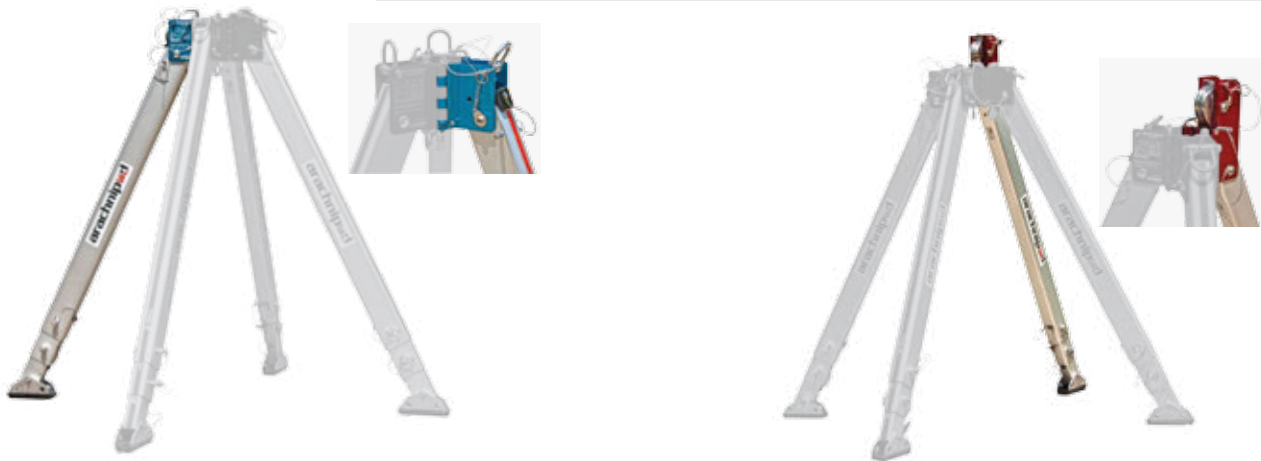

### STANDARD QUADPOD ADD-ON KIT

The Standard Quadpod Add-On Kit provides the components necessary to add a 4th leg to an Arachnipod Multipod.

**Components Included:**

- (1) Arachnipod Standard Leg • (1) Quad Plate • (1) Leg Bag

24481108 Standard Quadpod Kit

### PULLEY QUADPOD ADD-ON KIT

The Pulley Quadpod Add-On Kit provides the components necessary to add a 4th leg to an Arachnipod Multipod.

**Components Included:**

- (1) Arachnipod Pulley Leg • (1) Quad Plate • (1) Leg Bag

24481208 Pulley Quadpod Kit

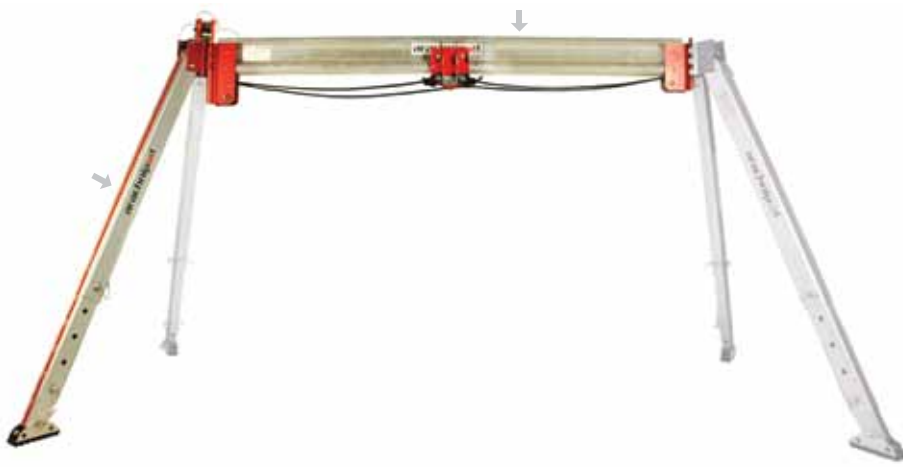

### BRIDGE ADD-ON KIT

The Bridge Add-On Kits convert existing Arachnipod Multipods into a Bridge System.

**Components Included:**

- (1) Arachnipod Bridge • (1) Standard Leg • (1) Feet Restraining Rope

24481702	2 Meter Bridge Add-On
24481703	3 Meter Bridge Add-On
24481704	4 Meter Bridge Add-On



(top) A Frame w/ Lazy Leg & Reverse head  
(bottom) Offset A-Frame

## ACCESSORIES

### WINCHES, KITS, PARTS



### ARACHNIPOD WINCH

Drum winch with 6mm cable. Interfaces with pulleys or pulley in the head of the Advantage or TEMS systems.

**WLL:** 485 lbs.

24481620	66 ft. (20 meter)
----------	-------------------



### FALL PROTECTION LIFELINE WITH RECOVERY WINCH

#### 3-Way Lifeline

Tough Aluminum housing with 3/16" galvanized steel cable with a load-indicating Autolocking Swivel Snap. Working load: 660 lbf. Meets ANSI Z359.1 and CE BS EN 360 requirements. Electrostatic powder painted. 100% inspected. Unit can be reset from winch mode back to fall protection mode. Attaches to the APOD with the mounting bracket listed below. Also, will attach to Technician Tripod (page 70) a with a separate bracket.

61943050	3 way x 50 ft.
24481690	APOD-FA Mounting Bracket



### APOD - ACCESSORY KIT

The APOD Full Accessory Kit contains many needed options for use with the Arachnipod. Included are steps that allow the user to reach the top of the tripod after set-up. Spike feet for rough terrain. A Rigging Equipment Bracket for control devices or auxilliary pulleys. Rigging Plates for stabilization. And much more.

**Components Included:**

- Accessory Bag (1), Spare Detent Pins (2), Spike Feet (4), Spare Leg Pins w/ Detent (1), Gin Head (1), Steps (2), Soft Ground Shoes (4), Equipment Bracket (1), Hold Down Stakes (4), Rigging Plate (1), M12 Tru-Bolts (8), Quad Plate (1), Spare Quik-Link Head Pins (2)

24481501	Full Accessory Kit Contents
----------	-----------------------------



### ARACHNI-PINS

The Arachni-Pin is the new design leg pin for the Arachnipod. It is now standard on all units (starting Fall 2012) and replaces the original pins that were locked in place with a lynch pin. Arachni-Pins have a locking mechanism that is released by depressing the thumb pin. The original pins are easily replace with the Arachni-Pins.

**2448680054** Arachni-pins



### SPIKE FOOT

The Spike Foot can be used for point loading and ground penetration applications. A stainless steel tip extends the service life of the Spike Foot. Simply remove the Standard Arachnipod Foot and insert the Spike Foot into the socket at the end of the Arachnipod Leg. Foot is held in place by steel detent pin.

**24481212** Spike Foot



### SOFT GROUND SHOE

The Soft Ground Shoe fits over the end of the Leg and is held in place by the Spike Foot. The Soft Ground Shoe limits ground penetration.

**24481515** Soft Ground Shoe



### HOLD DOWN STAKE

The Hold-Down Stake can be used to secure a standard foot to the ground. The foot locating spike lines up with one of the holes in the standard foot.

**24481516** Hold Down Stake



### LEG RIGGING BRACKET

The Equipment Bracket is attached to the lower leg section for use with mechanical advantage rigging. It can be rigged inward for use with the swivel rigging points or outward for use with the pulley head.

#### Load ratings per leg settings:

A1: 330 lbs; B2: 485 lbs.; C3: 661 lbs.

**24481519** Leg Rigging Bracket



### GIN HEAD

The Gin Head is used with the Lazy Leg to form a Gin Pole. Both Parts are colored blue to make leg selection an easy task. The Gin Head may also be used as a large rigging plate when not used in a gin pole configuration.

**24481511** Gin Head



### QUAD PLATE

The Quad Plate is used whenever 4 legs or heads are used together, such as a quadpod or lazy leg / reverse head configurations. The Quad Plate stabilizes the 4 head to maintain the square configuration created.

**24481520** Quad Plate



### RIGGING PLATE

The Rigging Plate is an essential piece of equipment when rigging an A-Frame/ Bipod system. It provides additional lateral stabilization attachment points. The plate is for stabilization purposes and is NOT a live load rigging point.

**24481211** Rigging Plate



### LEG STEP

The Leg Step is probably the handiest accessory for the Arachnipod. The Step can be attached to the middle or lower leg sections and is a useful aid when you need to reach the rigging points of a fully extended Arachnipod. The Steps are reversible and may be used inside or outside of the leg. The Step is not rated for rescue load applications.

**24481518** Leg Step

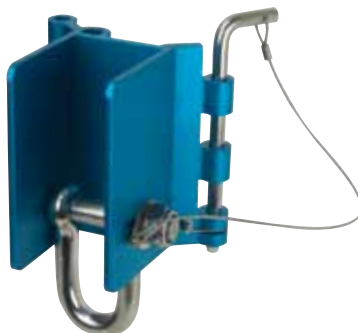

### REVERSE HEAD

The Reverse Head is used to change the angle between legs. It allows a standard, equilateral tripod to be transformed into a "flat-front" tripod (Standard or Lazy Leg configurations). The Reverse Head has a large D-Shackle rigging point that centralizes the load between the opposing side legs.

**24481412** Reverse Head

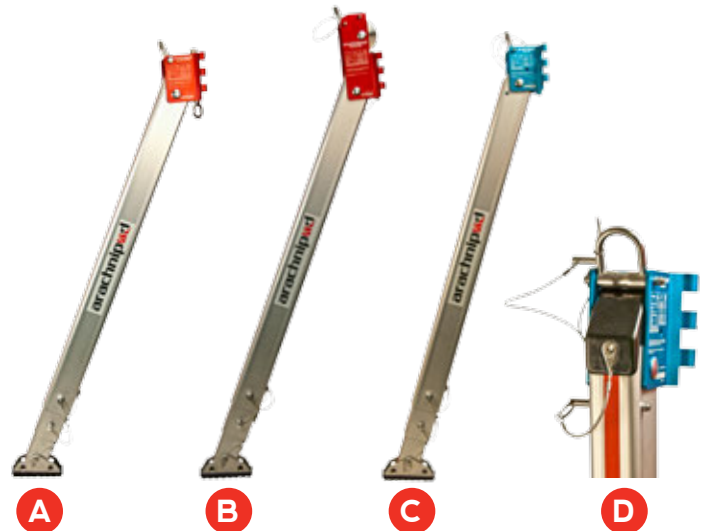

- A. 24481415** Standard Leg
- B. 24481417** Pulley Leg
- C. 24481416** Lazy Leg
- D. 24481512** Lazy Leg Adapter
- 24481419** Lazy Leg Extension Bracket





Swivel Eye Rigging Points  
Spring-Lock Mechanism Locks  
Legs into Place

## DELUXE TECHNICIAN TRIPOD

### Pulley Sheaves in Head for Rope/Cable

2 Swivelling Rigging points. Spring loaded leg locking mechanisms hold legs in place. Sheaves on head of tripod allow for integration of winches and fall blocks while allowing for increased height under the tripod head. Extruded head and snap out legs for quick and positive deployment. Available with optional load indicating attachment eyes. Manufactured from high strength alloy aluminum and stainless steel fittings.

**Strength:** 8,093 lbf. (36 kN)    **WLL:** 809 lbs. (368 kg)

**Weight:** 51.75 lbs (23.53 kg)    **Maximum Open Height:** 99.6"

**Minimum Open Height:** 70"    **Storage Dimensions:** 72" x 8.5" x 8.5"

6194101	Tripod
6194109	Tripod Bag
61945050	Winch, 50ft.
61945100	Winch, 100 ft.
61945059	Padded Winch Bag

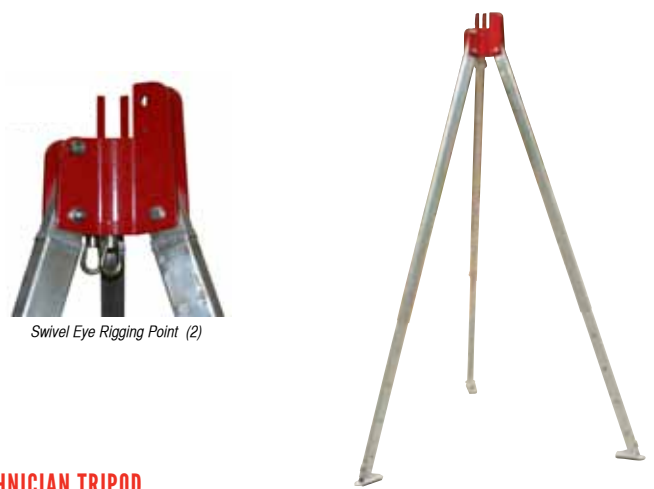

Swivel Eye Rigging Point (2)

## TECHNICIAN TRIPOD

To create a lighter, more economical tripod, we removed the sheaves from the Technician Tripod. What remains is the same high strength unit with 2 swivel rigging points. You can add the Pulley sheaves back to the unit with the Sheave Kit.

**Strength:** 8093 lbf. (36 kN)    **WLL:** 809 lbs. (368 kg)

**Weight:** 48.5 lbs (22 kg)    **Maximum Open Height:** 99.6"

**Minimum Open Height:** 70"    **Storage Dimensions:** 72" x 8.5" x 8.5"

6194103	Technician Tripod-Basic
6194105	Pulley Wheel Kit, each



## LARKIN RESCUE FRAME

An uneven tetrahedron that can replace a tripod or a small rooftop derrick crane for personnel lifting/lowering. The Larkin Frame swivels on its feet and can be set up as a standard tripod or tipped as shown in the photo to reach over an edge or parapet wall. It is especially useful on horizontal tanks with half walkways. The two feet must be secured to prevent slippage away from the breaker when the unit is tipped. Made in Australia. Patented

**Safe Working Load:** 600 lbs.    **Dimensions:** 8' x 10'

**Weight:** 87 lbs.    **Shipping Weight:** 94 lbs.

900200	Larkin Frame
--------	--------------

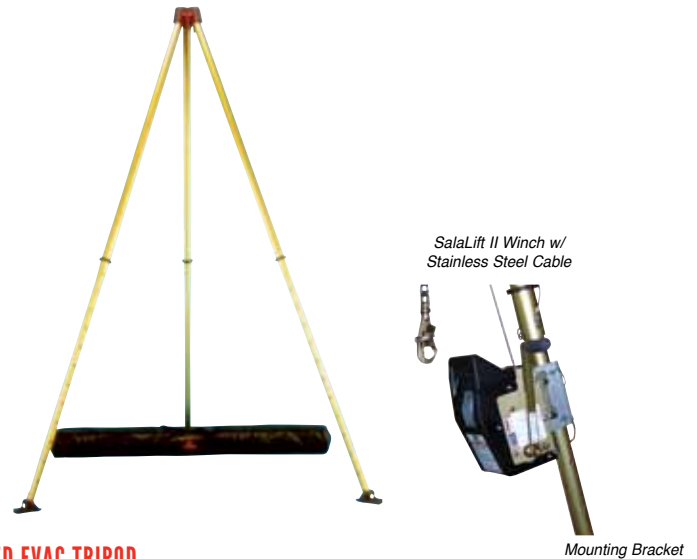

SalaLift II Winch w/  
Stainless Steel Cable

Mounting Bracket

## SKED EVAC TRIPOD

The Sked Evac Tripod extends to 9.9 feet with three anchors at the head. Anchors, Header, and Legs are interconnected with 1/2" Stainless Steel bolts for high strength.

<b>Extension:</b>	9'	6'
<b>Strength:</b>	5,280 lbf.	9,500 lbf.
<b>WLL:</b>	528 lbs.	950 lbs.
<b>OSHA Rating:</b>	1 Person	
<b>Bag Dimensions:</b>	89" x 6" 6"	----
<b>Weight:</b>	71 lbs.	---
<b>NFPA Rating:</b>	Light Use	

620510	Evac Tripod
620511	Carrying Bag for Evac Tripod

620515	Retracting Lifeline, 50'	620519	Mounting Bracket*
620516	SalaLift, 60' (1/4" Cable)	6102118	Cable Pulley
620517	SalaLift II, 90' (3/16" Cable)	201420030	AutoLocking Carabiner*
620518	SalaLift II, 120' (3/16" Cable)		

\*Required for use of Tripod with Winch or Retracting Lifeline



### SKYHOOK "T" OFF-ROAD FOUNDATION

This attachment gives the winch a large base for ground operations.

**Weight:** 4.8

615204 Ground Stabilizing Mount

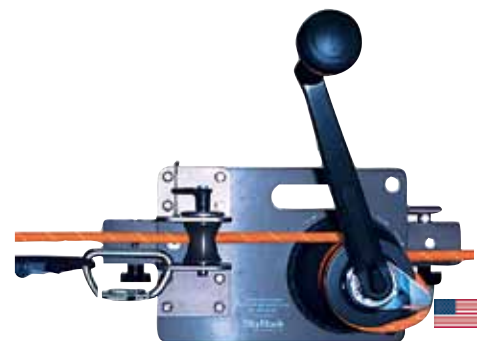

### SKYHOOK RESCUE WINCH

The SkyHook system is comprised of an anodized aluminum two-speed self-tailing winch, handle, and mounting system. Will connect to the Sked Evac Tripod. Offers ease of raising & hauling loads without the use of bulky block & tackle-style mechanical advantage systems. Best used with 1/2" ropes.

**Weight:** 21.5 lbs.

615201 SkyHook Rescue Winch



### SKYHOOK UNIVERSAL ANCHOR PLATE

Provides the winch a stable work platform for anchoring the winch to the ground, telephone poles, etc.

**Weight:** 9.7 lbs.

615205 Universal Anchor Plate



### SKYHOOK RECEIVER HITCH MOUNT

Allows the SkyHook winch to be mounted to a vehicle using a standard receiver hitch. The mount will pivot up to 45° in each horizontal direction to achieve proper rigging alignment.

615202 Receiver Hitch Mount



### SKYHOOK WEB ANCHORS

The SkyHook Web Anchor Set allows rescuers to quickly attach the Skyhook winch around a column, tree, abutment, etc. Very useful in Industrial and rural applications. Strong ratchet adjusters provide a tight and secure attachment.

615206 Web Anchors



### SKYHOOK POWER DRIVE

An electric powered power head turns the winch head. Includes Power Drive, stainless steel drive bit, attachment bracket, and storage box. 110 VAC.

**Weight:** 15.5 lbs. (With case: 21.2 lbs.)

615210 Skyhook Power Drive



### SKYHOOK CASE

Holds winch and winch drive system as well as Universal Anchor Plate.



615209 Skyhook Case

## WARNING

Technical rescue and safety is potentially hazardous. Any person using equipment sold by RESCUE TECHNOLOGY in any manner is personally responsible for learning the proper techniques involved, and assumes all risks and accepts full and complete responsibility for any and all damages or injury of any kind, including death, which may result from the use of any RESCUE TECHNOLOGY equipment.



# STRETCHERS & LITTERS

## PATIENT TRANSPORT

RescueTECH offers the best of Rescue Stretchers and Backboards for Technical Rope Rescue. Galvanized Steel Stretchers, Stainless Steel Stretchers, Plastic Stretchers, Marine Wood Back Boards, Plastic Backboards. Includes products by RescueTECH, Traverse, Junkin. Great for High Angle Rescue, Confined Space Rescue, Water Rescue, Search and Rescue.



A. ATR2 Rescue Trailer  
B. Medical Tray and Medic Seat  
C. Lexan Cover  
D. Medic Seat

### ATR2 RESCUE TRAILER

*Full suspension comfort for patient transport*

The All Terrain Res-Q 2 model was designed for those with limited storage space. The ATR2 features a fully welded chassis made from durable rectangular tubing and schedule 40 pipe with a suspension system consisting of hydraulic assist shocks and coil spring. Towable behind a ATV via the dual hitch configuration. If the ATV does not have a 1-7/8 inch ball, you just slide the hitch out and reverse it and you can attach via standard draw pin style. Standard features are: Split frame with locking pin, Dual Hitch System, 22 x 11 x 8 ATV Tires, Stainless Steel IV Pole, Standard Hubs on Axle, Dual Ratchet Style Straps for attaching stokes litters, 750# capacity coil spring, hydraulic assist shocks. Folds for storage (46" w x 36" d x 63" h). U.S. Patent: 7,131,666. Litter not included.



A. 2394102 ATR2 Rescue Trailer  
B. 2394115 Medical Tray

C. 2394113 Lexan Cover  
D. 2394111 Medic Seat



### STRETCHER TRAILER

Aluminum Litter Trailer for litter transport. Easily disassembles for storage. Nylon Powder Coated. Sets up in approximately 3 minutes. Litter not included.

**Ground Clearance:** 21" **Length:** 72"

**Width:** 27" or 40" **Weight:** 71 lbs.

Litter not included.

620350	Stretcher Trailer
620355	ATV Adapter Kit



ATV Adapter Kit



## WARNING

Technical rescue and safety is potentially hazardous. Any person using equipment sold by RESCUE TECHNOLOGY in any manner is personally responsible for learning the proper techniques involved, and assumes all risks and accepts full and complete responsibility for any and all damages or injury of any kind, including death, which may result from the use of any RESCUE TECHNOLOGY equipment.



  
**WARNING**

Technical rescue and safety is potentially hazardous. Any person using equipment sold by RESCUE TECHNOLOGY in any manner is personally responsible for learning the proper techniques involved, and assumes all risks and accepts full and complete responsibility for any and all damages or injury of any kind, including death, which may result from the use of any RESCUE TECHNOLOGY equipment.



Stretcher not included

**MULE LITTER WHEEL WITH HANDLES**

*8-Way Adjustable Handles*

This is a modified version of the Original MULE Litter Wheel that adds handles to both ends of the unit. The single-wheel design allows for ease of movement in the roughest terrain. Ideally suited for narrow rough trails giving the patient a smooth ride even across slopes. The two securing straps (2 hooks per strap) are each rated to 1,000 lbf. and use a strong and durable ratchet-locking device.

**Shipping Weight:** 45 lbs.

620361 Mule Litter Wheel w/ Handles



**RESCUETECH TAPERED STOKES STRETCHER**

The RT Stretcher provides an economical choice for the rescue professional. Cold Rolled tubing and a full length steel strip backing for strength and rigidity.

**Dimensions:** 84" x 23.5" x 7.25" **Interior Depth:** 6"

**Strength using standard rigging points:** 2550 lbf. **Weight:** 34 lbs.

**Shipping Weight:** 40 lbs.

**Product features:**

*.25" Diamond Mesh insert • Full length steel strips provide backboard-like rigidity\* • Rescue-Grade Patient Straps • Electrostatic Powder Coat Finish*

*\*Does not replace proper patient packaging using backboard, cervical collar, and headblocks. Shipped via motor freight.*

620112 Tapered Stokes Stretcher



**RESCUETECH RECTANGULAR STOKES STRETCHER**

The Rectangular Stretcher builds on our popular Tapered Stretcher design. It is designed to be symmetrical from end-to-end and to allow larger sized, rectangular backboards to easily fit inside. Cold Rolled tubing and a full length steel strip backing for strength and rigidity.

**Dimensions:** 84" x 23.5" x 7.25" **Interior Depth:** 6"

**Strength using standard rigging points:** 2550 lbf. **Weight:** 37 lbs.

**Shipping Weight:** 43 lbs.

**Product features:**

*.25" Diamond Mesh insert • Full length steel strips provide backboard-like rigidity\* • Rescue-Grade Patient Straps • Electrostatic Powder Coat Finish*

*\*Does not replace proper patient packaging using backboard, cervical collar, and headblocks. Shipped via motor freight.*

620114 Rectangular Stokes Stretcher



**RESCUETECH CONFINED SPACE STOKES STRETCHER**

An updated version of the traditional wire mesh stretcher. This version features our popular 0.25" durathene mesh insert and rescue-grade straps. Tested to 1500 lbs.

**Dimensions:** 81 1/2" x 18 3/8" x 7 3/4" **Strength:** 2550 lbf.

**Weight:** 32.6 lbs. **Shipping Weight:** 38 lbs.

*\*Does not replace proper patient packaging using backboard, cervical collar, and headblocks. Shipped via motor freight.*

620113 Stokes Stretcher



### RESCUETECH STAINLESS STEEL RECTANGULAR STOKES STRETCHER

A stainless steel version of our Rectangular Stokes Stretcher. Includes a special Mesh insert with a .25" diamond pattern for greater strength, and better patient packaging than .5" patterns. A new style ABS back plate provides a sturdy, yet comfortable base for the patient. We have also added rescue-grade nylon Quick-Fit Stretcher Straps for securing the patient.

**Dimensions:** 84" x 24" x 7.25" **Interior Depth:** 6"

**Strength using standard rigging points:** 2550 lbf. **Weight:** 29.3 lbs.

**Shipping Weight:** 35 lbs.

\*Does not replace proper patient packaging using backboard, cervical collar, and headblocks. Shipped via motor freight.

620124 S.S. Rectangular Stokes



### RESCUETECH EXTRA-WIDE STOKES

For those special rescues where the basic sized stretcher will not work. 32" wide at the rail and lined with our 0.25" diamond pattern durathene mesh. Included 4 rescue-grade patient straps\*.

**Dimensions:** 85" x 32" x 8" **Strength:** 2550 lbf.

**Weight:** 31 lbs.

\*Does not replace proper patient packaging using backboard, cervical collar, and headblocks.

620125 RT Extra-Wide Stokes

### RESCUETECH STAINLESS STEEL TAPERED STOKES STRETCHER

*Super Strong to meet Mil-Spec*

We designed this stretcher based upon Junkin's top of the line Military Stainless Steel stretcher. This stretcher meets the Mil-Spec 2,500 lb. load rating - tested from the ends of the stretcher to give a more accurate measure of strength\*. We add a special Mesh insert with a .25" diamond pattern for greater strength, and better patient packaging than .5" patterns. A new style ABS back plate\*\* provides a sturdy, yet comfortable base for the patient. We have also added rescue-grade nylon Quick-Fit Stretcher Straps for securing the patient.

**Dimensions:** 84" x 24" x 7.25" **Interior Depth:** 6"

**Strength using standard rigging points:** 2,500 lbf. **Shipping Weight:** 33 lbs.

Shipped via motor freight.

\*Other brands test from rigging points to give an artificially higher strength rating rather than the required Mil-Spec Strength rating.

\*\*Does not replace proper patient packaging using backboard, cervical collar, and headblocks.

620122 S.S. Tapered Stokes



### QUICK-FIT™ STOKES LASHING SET

Packaged set of RescueTECH's Quick-Fit Stretcher Straps. Provides rescue-grade outside lashing for the vertical environment. Complete with 4 red and 1 Yellow strap and storage pouch.

**Weight:** 54 oz.

6201530 Stokes Lashing Set



### CLIK-LOK STOKES LASHING SET

We have updated our popular Stokes Lashing set with our rescue grade Click-Lok Buckles. These buckles "click" together like a seat belt buckle. But, they are rescue strength and require that both release tabs be depressed before the buckle will open. Includes 5 Straps (1 yellow, 4 red) and deluxe storage/carrying bag.

6201535 Click-Lok Lashing Set



### CONFINED SPACE LITTER



A narrow version of the Wire Basket Stretcher. Only 19" wide and fits through nearly all accessible manholes. Used with either 4 or 6 point litter bridles. Hexagon mesh wire netting. Tested to 1500 lbs.

**Dimensions:** 81 1/2" x 18 3/8" x 7 3/4" **Weight:** 23.7 lbs.

**Shipping Weight:** 29 lbs.

Shipped via motor freight.

620103

Confined Space (JSA-300CS)

### WIRE BASKET STRETCHER

Traditional design wire basket stretcher manufactured from rugged 5/8" tubular steel frame with 3/16" x 3/4" flat wire braces. Hexagon mesh netting (18 gauge). Used with either 4 or 6 point litter bridle. Tested to 1500 lbs.

**Length:** 80.5" **Widths:** 22 1/2"- chest, 22"- abdomen, 21.5"- thigh, 20.5"- calf

**Height:** 8" **Weight:** 25.6 lbs.

**Shipping Weight:** 31 lbs.

Shipped via motor freight.



620101

Wire Basket Litter (JSA-300W)

### PLASTIC STRETCHER



The Plastic Stretcher combines the open top railing desirable on standard wire basket litters with the plastic bottom desired for smooth transport. Made from yellow, high density polyethylene shell, supported by a Stainless Steel outer rail. Shell is permanently attached to rail using semi-tubular Stainless Steel rivets (not pop rivets). Steel rail facilitates handling of the stretcher at all points along sides and ends of stretcher. Includes molded runners and a sealed, closed cell foam pad. The Plastic Stretcher will accept a full size rectangular backboard.

**Load capacity:** 1,200 lbf. **Dimensions:** 84.5" x 24" x 7.5"

**Weight:** 31.6 lbs. **Shipping Weight:** 37 lbs.

**Color:** Yellow

Shipped via motor freight.



620115

Plastic Stretcher (JSA-200)

### MASS CASUALTY FLEXIBLE STRETCHER

Constructed of specially compounded orange or gray 18oz. vinyl-coated nylon that is easily washed with soap and water. Highly resistant to acids, alkalis and penetration of liquids. Five (5) removable hardwood slats positioned between two layers of the 18oz. fabric provide strength and rigidity. Shorter slats are placed in torso area only to make stretcher lighter and more compact. Lightweight – 13 lbs. Compact and portable – opens to 78"L x 28"W; closes to 35"L x 6"W. Six (6) handles ergonomically placed for ease of transport. Three (3) polypropylene web patient security straps for immobilization. Load capacity – 350 lbs. Carry bag with shoulder strap. One person can carry up to ten (10) of these stretchers when responding to an incident.



20701040

Color

20701047

Orange

Grey





## ADJUSTABLE LITTER BRIDLE

*Vertical, Horizontal, and Low Angle Lifting*

Same as our original 4-Point Litter Bridle but with 1 3/4" forged adjusters. Adjusters allow for independent adjustment of the four support straps during rescue. Complete with 3" forged "O" ring and 4 locking litter snaps. Also available without snaps to use with heavy duty carabiners for litter attachment. Converts for low angle use. Tensile Strength: 5,000 lbf. Color: Orange with contrasting straps. We suggest the 60511820 RescueTECH Large D, Steel Carabiner. Bridle Kit includes: Bridle, Tender Rope and Carrying Bag.

		Weight
620185	Bridle with Snaps	7.15 lbs.
620188	Bridle WITHOUT Snaps	4.15 lbs.
620189S	Bridle Kit w/ Snaps	8.75 lbs.
620189	Bridle Kit WITHOUT Snaps	5.4 lbs.



## 2-PIECE LITTER PRE-RIG

The Pre-Rig is a fully adjustable bridle intended for use with any stokes litter. The unique "Y" suspension system drastically reduces congestion at the upper attachment point. Adjustable to a minimum height of 18" above the litter for the tightest helicopter evacuations and a maximum length of 5 feet. One half of the Pre-Rig can be used as a low angle evacuation stretcher harness, eliminating the need to purchase separate harnesses. Combines with a rescuer rigging rope or Transfer Sling for a complete litter/rescuer system. Litter Pre-Rig is made of 6,500 lbf. webbing and quick adjust Mil-Spec forged hardware.

**Strength:** 5,000 lbf. **Weight:** 3 lbs.

All webbing and hardware meet NFPA strength specifications.

620183	2 Piece Litter Pre-Rig
--------	------------------------



## CONVERTIBLE LITTER BRIDLE

*Vertical, Horizontal, and Low Angle Lifting*

Ideal for all standard lifting applications. Designed for single rope rigging, the 4-Point Litter Bridle attaches directly to the railing of all types of stretchers. Two 1" heavy duty type 18 nylon slings (Webbing Strength: 6000 lbf.) are looped through a 3" forged steel lifting ring to allow end-to-end height adjustment. Connects to litter with four forged locking snap links (included).

**WLL:** 600 lbs **Weight:** 4.75 lbs.

**Color:** Red

620180	4-Point Convertible Litter Bridle
--------	-----------------------------------



## LOW-ANGLE LITTER BRIDLE

Ideal for scree-slope and other low angle litter operations. Provides stable, secure connection. Manufactured of high strength webbing and forged steel hardware. Attaches to sides and end of litter.

**Strength:** 5,100 lbs. **Weight:** 2.3 lbs.

**Color:** Black

620181	Low-Angle Litter Bridle
--------	-------------------------



## LITTER ATTENDANT SLING

A handy adjustable sling that attaches to litter railing with a girth hitch. Similar in design to our standard transfer sling. V-ring adjuster attaches to rescuer. Great for litter transport.

**Extended Length:** 40" **Weight:** 8 oz.

756111	Litter Attendant Sling
--------	------------------------



## STRETCHER EQUIPMENT PACK

*Holds all Harness and Hardware*

A new equipment pack designed to hold all items needed for securing patient and stretcher movement in a vertical environment. Two zippered pockets hold webbing, hardware, litter bridles, victim harnesses, and much more (not included). Come complete with carrying handle. Stretcher attachment system is complete with high strength buckles.

**Dimensions:** 18" x 10" x 5" **Weight:** 27 oz.

620172	Stretcher Equipment Pack
--------	--------------------------

## PATIENT STOKES HARNESS

Special design harness that provides inside patient lashing. Designed to stay attached to stretcher then attached to patient. Complete with chest and seat harness section. Easily donned. To be used in addition to a rescue-grade wire basket or plastic stretcher with proper technical rescue patient lashing.

Weight: 40 oz.



6201540

Patient Stokes Harness

## PATIENT PACKAGING SET

Complete system for patient restraint in the vertical environment. Set includes Stokes Harness, Patient Lashing Set, and Stretcher Equipment pack.

Weight: 7.35 lbs.



\*Manikin and Stokes not included

299842121

Quick-Fit™ Patient Packaging Set (shown)

299842125

Clik-Lok Patient Packaging Set

## STRETCHER HARNESS KIT

An upgraded version of our original Patient Packaging set. We have added Litter Bridle and equipment for the attendant(s).

- *Stretcher Patient Harness (1) • Clik-Lok Stretcher Lashing set (1) • Stretcher Equipment Pack (1) • RD70 Carabiners (4) • OD50 Carabiner (1) • Litter Attendant Sling (4) • Gibbs Ascender (2) • Deluxe Rescue Etrier (1) • Adjustable 4 pt Litter Bridle Kit (1)*



299842130

Stretcher Harness Kit



### STRETCHER BLANKET

#### Traditional Packaging Tool

The finest cot and stretcher blanket available for patient packaging. Provides excellent insulation characteristics. Note: Proper basket litter operations require a minimum of two blankets. 70% Wool, 30% Synthetic Fiber.

**Size:** 82" x 62" **Weight:** 42 oz.

620160 Stretcher Blanket



### HEAVY DUTY SPACE BLANKET

#### Lightweight Superinsulator

Reflects and retains up to 80% of radiated body heat to prevent post trauma shock resulting from an accident or natural disaster. Waterproof, windproof and durable. Multiple layers are flexible even in sub-freezing temperatures.

**Dimensions:** 84" x 60" **Weight:** 12 oz.

620165 Heavy Duty Space Blanket



### EMERGENCY BLANKET

Known for years as a Space Blanket, this mylar sheet works great as a thermal insulator. Small enough to fit in your shirt pocket, yet opens to a full 56" x 84" size. Stays flexible in freezing temperatures. Wind and waterproof.

**Weight:** 1.5 oz.

2282127032 Emergency Blanket



### CMI DRAG HOOK

Manufactured of forged steel eyebolt and five 4140 chromemoly steel tines. Each tine is heat treated to resist a load of approximately 2,000 lbf. Each Drag Hook is sandblasted and coated with baked-on epoxy coating. Available Deployment Bag is specifically designed for use with the Drag Hook.

**Dimensions:** 12.75" x 8.5" **Weight:** 2.75 lbs.

**Color:** Black

624100 Drag Hook

624105 Deployment Bag



### STADIUM SEAT

For use in fast, safe transportation of victims from stadiums, sport facilities, arenas, theaters, or anywhere multiple steps create problems in removing patients. Lightweight - weighs only 4.5 lbs. Strong - accommodates up to 350 lbs. Durable - made of 18oz. vinyl and hardwood slats. Compact - folds to 20" x 7" in carrying bag. Safe - 2 nylon seat belts secures patient. Portable - can be stored in a minimum of space. Easy to use - 5 web handles for lifting and carrying.

20700059 Stadium Seat



### LITTER COVER

#### Protects Stretcher from the Elements

Manufactured from durable vinyl coated polyester for extra strength and durability. Double stitched seams and Vislon Zipper. Compression straps secure the bag to the stretcher. Zippered opening of 1/2 of the top panel eases insertion of the stretcher. Fits all standard and confined space stretchers.

**Dimensions:** 90" x 30" x 10"

Stretcher not included.

620175 Litter Cover



### BASKET STRETCHER FLotation KIT

For use with all basket stretchers to provide flotation during patient handling in water. Easily attached with hook and loop fastener to any Stokes type stretcher. Flotation bats are Dow EthaFoam and covered in Cordura™ Nylon. Kit is ready to attach to any Junkin stretcher.

**Weight:** 5 lbs. **Color:** Orange.

620321 Flotation Kit



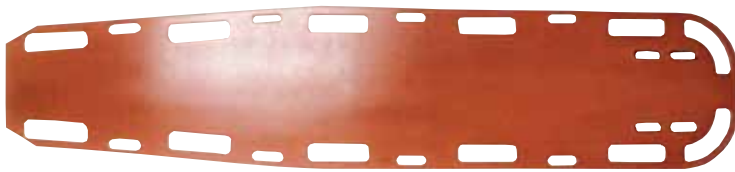

### MARINE PLYWOOD BACKBOARD

Manufactured of 3/4" weather-proof Marine Plywood finished with two coats of clear varnish. Large hand cut-outs for easy handling. 3/4" runner on bottom for easy lifting. Special shape fits inside Wire Basket Stretcher. Speed clip version requires purchase of up to 5 Speed Clip Straps.

**Shipping weight:** 23.5 lbs. **Dimensions:** 73" x 17" x 3/4"

**Weight:** 18.3 lbs.



620231 - Speed Clip Straps

620201	Full Length
620202	Full Length, Speed Clip Pins
620212R	14" Confined Space (runners)
620231	Strap for Speed Clip Boards



### LIGHTWEIGHT BACKBOARD

#### X-Ray Translucent Molded Plastic

Manufactured from the highest grade PVC. Special design is lightweight and easy to clean. Compatible with Patient Restraint Straps and Backboard Strap.

**Shipping Weight:** 22 lbs. **Color:** Yellow

**Dimensions:** 73" x 17" x 3/4" **Capacity:** 400 lbs.

**Weight:** 18.3 lbs.



620210	L/W Backboard
620211	L/W Backboard w/ Pins

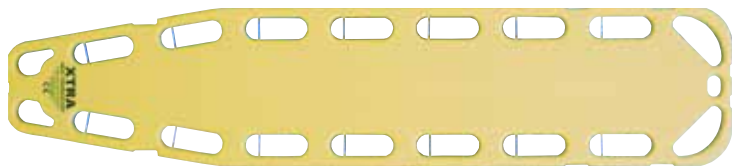

### XTRA BACKBOARD

#### Standard and Pin Versions

Designed to be one of the most rigid backboards available. Fully x-ray transparent between the handholds and provides approximately 50% greater clear area at the head of the backboard. High buoyancy for water rescue. Works with all head immobilizers and strapping systems. Easily cleaned. Version with Pins has 14 pins for precise strap placement.

**Shipping Weight:** 20 lbs. **Colors Available:** Yellow (2), Orange (0), Red (4), Blue (6). Substitute number in parentheses for the "X" in the stock number. **Dimensions:** 71" x 15.75"

**Capacity:** 500 lbs. **Weight:** 17 lbs.

2149810X	Xtra Backboard
2149820X	Xtra Backboard w/ Pins



### ALUMINUM DECON POLE STRETCHER

#### Open Mesh Design

Ideal for decontamination. Easily set up and compact for storing. This Medical Corps type litter is light in weight with shaped hardwood handles. Cover is durable 18 oz. vinyl coated nylon.

**Open Dimensions:** 87" x 22" x 4.5" **Folded Dimensions:** 43.5" x 3.5" x 7.5"

2026601M	Aluminum Decon Pole Stretcher
----------	-------------------------------



### BACKBOARD HEAD IMMOBILIZER

Designed and recommended for immobilization only. Item includes: two head support pillows with ear openings; base with center pad and two backboard retention straps; straps for head positioning; and a vertical stabilization strap to maintain immobilizer placement at head of the board.

620224	Head Immobilizer
--------	------------------



### AMBU PER-FIT ACE

The Per-Fit Ace adjusts to ANY adult-size neck with 16 different settings ranging from neckless to tall.

• Stores completely flat • Horizontal sizing line • Radiolucent, CT & MRI compatible • Safety buttons for maximum reliability

23466884	AMBU Per-Fit Ace
----------	------------------

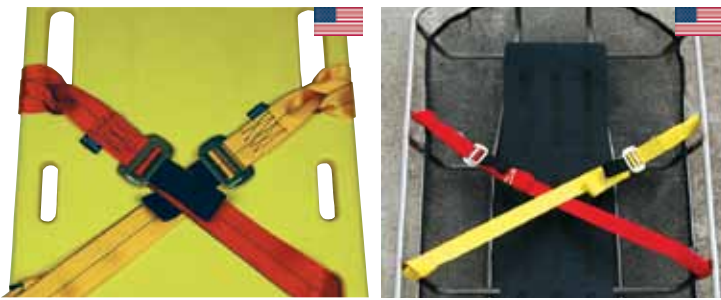

### QUICK-FIT PATIENT STRAPS™

*For Backboards and Stretchers*

A rescue-grade strap for use with stretchers and backboards. 2 piece versions consists of two straps with a loop at one end, to girth hitch around stretcher rail, and a connector at the other end. 1 piece version is a single strap designed to wrap completely around a backboard or litter. An excellent alternative to "seat buckle" style connectors. Two-piece buckle is manufactured of steel and require movement in two planes to detach. Easy to connect and adjust. Suitable for Technical Rescue Use.

**Color:** Yellow **WLL:** 600 lbs.

**Length, 2-pc:** 70" **Length, 1-pc:** 108"

		Color			Color
6201522	2-Pc Quick-Fit	Yellow	6201532	1-Pc Quick-Fit	Yellow
6201524	2-Pc Quick-Fit	Red	6201534	1-Pc Quick-Fit	Red
6201521	2-Pc Quick-Fit	Black	6201531	1-Pc Quick-Fit	Black



### CLIK-LOK PATIENT STRAPS™

*For Backboards and Stretchers*

Manufactured with our new Clcik-Lok Buckle, the 2-Piece version is affixed to backboards and stretchers with a girth hitch. The 1-Piece wraps completely around the backboard or litter. Constructed of 1.75" flat nylon webbing (Tensile Strength: 5,500 lbf.) and Clcik-Lok adjuster buckles. We recommend crossing the chest area using different color slings to aid in proper buckle attachment.

**Strength:** 5,500 lbf. **WLL:** 600 lbs.

**Length 2pc.:** 70" **Length 1pc.:** 108"

**Weight:** 11.2 oz.

		Color			Color
6201512	2-Pc Clcik-Lok	Yellow	6201562	1-Pc Clcik-Lok	Yellow
6201514	2-Pc Clcik-Lok	Red	6201564	1-Pc Clcik-Lok	Red
6201511	2-Pc Clcik-Lok	Black	6201561	1-Pc Clcik-Lok	Black

### TRIPLE X BACKBOARD STRAP™

*Innovative Design from Conterra*

New strap system that has twelve separate overlapping Velcro® straps that quickly and securely immobilize a spine injured patient to virtually any spine board. Easy deployment. Simply align the three sets of "X" formation straps over the corresponding weight centers of the body (upper chest, pelvis, legs). Thread tie straps through the backboard holes and pull tight. Machine washable 2" webbing, 1.5" velcro. Reflective striping on center alignment strap. Complete with zippered carrying case.

**Weight:** 28 oz.

621131	Triple X BackBoard Strap
--------	--------------------------

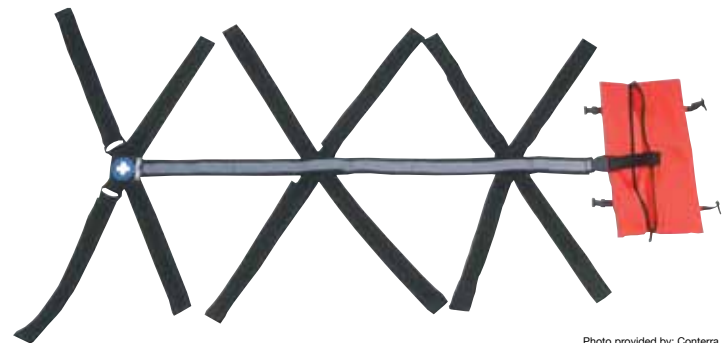

Photo provided by: Conterra



Backboard not Included

### STANDARD BACKBOARD MULTI-STRAP

*Traditional Design*

Strap system that has eight straps that quickly and securely immobilize a spine injured patient to virtually any spine board. Easy deployment from included storage bag. Thread straps through the backboard holes and pull tight. Machine washable 1.5" webbing, 1.5" velcro. Reflective striping on center alignment strap. Complete with zippered carrying bag that will attach to backboard or litter for convenient storage.

**Weight:** 22.5 oz.

620155	BackBoard Multi-Strap
--------	-----------------------



## REEVES SLEEVE

*Immobilizes Patients for Transport*



A unique product that converts a full size backboard into a patient immobilization device to be used for vertical and horizontal lifting. Perfect device for confined space rescue because it fits over the backboard (not included). DOES NOT CAUSE FEET TO ANGLE OUTWARD as do popular plastic lifting devices. Sleeve material is a vinyl laminated nylon that meets Mil Spec C 4300 Type 1, Class 1 anti-fungal vinyl and is resistant to acids, alkalies, and liquids. Lifting straps are constructed from 6,000 lbf. Tensile Strength webbing. Reeves Sleeve II has extra webbing reinforcement for greater strength.

**Color:** Orange. **Storage Dimensions:** 24" x 12" x 9"

**Full Dimensions:** 76" x 24" **Weight:** 16.85 lbs.

**Note:** This product, when used with a quality backboard, provides the best medical access of any confined space immobilization devices.

620401	Reeves Sleeve
620401S	Reeves Sleeve, Metal Buckles
620401R	Reeves Sleeve, Reinforced
620402	Reeves Sleeve II
20700049	Replacement Head/Chin Strap



## REEVES SLEEVE DRAG VERSION

*Tough, Low Friction Bottom*

A special conversion of the traditional Reeves Sleeve that adds a special drag sheet. The sheet reduces drag and protects the sleeve in rough environments.



620403	Reeves Sleeve Drag Version
--------	----------------------------



## LSP HALF BACK™

A versatile short body immobilization board designed for suspected cervical/spinal injuries during confined space rescues. Leg straps support lower body during lifting. 6 handles. Closed cell foam interior and metal back stay.

**Weight:** 10.75 lbs.

2322710	LSP Half Back
2322711	Vertical Lift Straps for LSP
2322716	Half Back Carrying Case



## MILLER BODY SPLINT™

Complete with a full head and body restraint harness. Rigid foam core provides both strength and buoyancy (will float 250 lbs. in fresh water.) Split leg design.

2154700	Miller Body Splint
2154720016	Carrying Case



## SPEC PAK™

*Includes Horizontal Lifting Bridle*

Unique Patient Packaging and Extrinsic System combines' backboard immobilization of a "Short Board" along with the suspension and support of a full body harness. The Spec Pak System utilizes an integrated polyethylene board along the back of the harness system to reduce wear and allow for a smooth sliding surface for confined space operations. Grab handles located on the sides and head of The Spec Pak aid rescuers during movement of patient through confined spaces. The Spec Pak System is very useful for any confined space operations where a vertical environment is encountered. Spec Pak is a fully certified lifting harness (ANSI Z359.1-1992), thus eliminating the need for a separate victim harness. Unique self-adjusting cervical restraint eliminates the problem associated with lifting patients vertically while secured to a rigid backboard. NEW head pad system helps prevent hyper-extension of cervical area. Spec Pak is only intended as a limited spinal immobilization system. Spec Pak must be used with proper spinal immobilization such as the use of a "Cervical Collar" where conditions and protocols dictate.

620410	Spec Pak
--------	----------





## OREGON SPINE SPLINT II

Absolutely the best spinal immobilization / extraction device available. Preferred to K.E.D., XP-1, and LSP. It immobilizes the spine and the shoulders at the same time. When applied it allows easy access to the patient's chest or abdomen for treatment or diagnosis. The chest straps hold the patient more securely than other devices, but does not restrict breathing. It folds up extremely small to fit in its carrying bag. Non-absorbing materials for easy cleaning.

**Weight:** 9.1 lbs.

620500 Orange (SK-300-OR)



## SKED® STRETCHER

The SKED® basic system includes the SKED® stretcher, Cordura™ backpack, horizontal and vertical lift systems, tow strap and webbing handles. Requires Backboard for proper patient immobilization. Excellent in rescues which require the unit to be dragged through a narrow space.

**Weight:** 16 lbs.

Color

620415	Sked Stretcher, Complete (SK-200-OR)	Orange
620415C	Sked Stretcher, Cobra, Complete (SK-200-OR)	Orange
620420	Half Sked Patient Drag (SK-220)	
620450	Sked Flotation Kit (SK-600-OR)	
620452	Sked Rapid Deployment Conversion Kit (SK-651-OR)	



## HAZ-MAT PATIENT TRANSFER SYSTEM

Includes everything needed for a rapid evacuation of mass casualties in a haz-mat environment. Includes continuous loop shuttle rope for distances of 100', 150', and 200'. The system allows as many as 4 rescuers in Level A suits to load patients onto the shuttle. System includes: 12 HMD Sked Stretchers, Rescue Winch System, 2 Knot Passing Pulleys, 14 Carabiners, Accessory Cord, 8 Rope Grabs, and 100' Extension Cord w/ Reel. Hitch pin not included.

21172520 Patient Transfer System \$11,500.00



## SKED HAZ-MAT

A SKED designed for mass casualty and Haz-Mat Use. Complete with cut-in hand holds and disposable slings. Stretcher is easily decontaminated.

620416	Sked Haz-Mat (SK-250)
620417	Body Only (SK-251)
620418	Haz Mat Straps (SK-252)
620419	Deployment Case (SK-253)



## SKED SIDE RELEASE BUCKLE CONVERSION KIT



*Quick Connect/Quick Release*

Skedco/Cobra side release buckles that meet the needs of securing a patient into a Sked® stretcher. Buckles rated at 3000 lbf. Durable and easy to use. With these buckles you will no longer have to weave the webbing through the buckles when packaging a patient. Patient packaging is often done in about half of the time as when using the original buckles.

2117208C Side Release Conv. Kit

# RUTH LEE

## GENERAL PURPOSE TRAINING MANIKINS

Ruth Lee Ltd has designed and manufactured high quality rescue equipment and training manikins for over 30 years in the UK. They have partnered with Rescue Technology to bring their market leading success to the US. All the different models are made in exactly the same way, with an inner body weighted with aggregate to human proportions, held inside the outer carcass. The aggregate is distributed around the body in weighted packets in such a way that slumping of the weight is prevented, allowing the dummy to maintain its form during and after use. The three main types, Firehouse (FH), Water Rescue (WR) and General Purpose (GP), all use different materials; the GP manikins (our most popular models) use heavy duty canvas, Nylon and polyurethane foam, while the FH models are made using Nomex blend material. The WR manikins use P.V.C, Nylon mesh and non absorbent foam. All manikins apart from the FH models are reinforced using high density polypropylene webbing.



\*Features may vary on manikin models.



### GENERAL PURPOSE TRAINING MANIKIN

#### More Realistic Performance / Weight Vest Provides Variable Weight

Rugged, realistic in size, weight distribution and handling characteristics. Manufactured using a flexible inner core, an outer shell, and protective overall. The inner core is weighted to human proportions using 4.4 lb. weight packets. For structural integrity, the packets are sewn to a nylon "inner dummy" with all the body parts (arms, legs, chest, etc.) held in place with webbing. The outer layer is 15 oz. Rot-resistant Canvas. All seams are double stitched and reinforced with webbing for improved abrasion resistance. The included protective coveralls protect the manikin from dirt and abrasion and are reinforced with high strength webbing in high stress areas. All manikins 44 lbs and up are supplied with lug sole boots that are secured to the manikin. Optional weight vest fits underneath the coverall and allows weight to be added or removed as needed to achieve the desired Manikin weight.

		Weight	Height
23951005	Infant	11 lbs.	2' 3"
23951010	Toddler	22 lbs.	2' 10"
23951020	Youth	44 lbs.	4' 3"
23951020A	Extra Light Adult	44 lbs.	5' 11"
23951030	Light Adult	66 lbs.	5' 11"
23951050	Standard Adult	110 lbs.	5' 11"
23951070	Heavy Adult	154 lbs.	5' 11"
23951100	Extra Heavy Adult	200 lbs.	5' 11"

#### Replacement Reinforced Coveralls

23959605	Repl. Coverall - Infant
23959610	Repl. Coverall - Toddler
23959620	Repl. Coverall - Youth
23959670	Repl. Coverall - Adult
23959701	Replacement Boots



### SHOUTBOX EXTRICATION MANIKIN

We have combined our Multi-Trauma Manikin and the Shoutbox manikin voice box to create an advanced extrication training manikin. The Multi-Trauma manikin is clothed in a special reinforced coverall (not shown) and will allow simulation of full and partial amputations of the right arm and right lower extremity. The manikin also has a thoracic impalement feature. The include Shoutbox manikin voice box adds to the realism with looping or sound activated victim response.

The Ruth Lee Manikins give the most accurate representation of a trapped victim. All anatomical proportions are correct in length, size and weight.

#### Weight

239586030	66 lbs.
239586050	110 lbs.

### RUTH LEE SHOUT BOX

The ShoutBox™ can be used in conjunction with any Ruth Lee Adult Training Manikin with an anatomically shaped head and will radically change the way in which rescue training is carried out. The ShoutBox™ is an interactive voice recorder which allows the instructor to record a message specific to the day's training exercise. For example, in a search and rescue exercise, the instructor can have the manikin call out a pre-recorded message to rescuers or make coughing sounds to alert the rescuers of its presence. The ShoutBox can emit sounds in a loop (with user-selectable repeat intervals) or have the message play by sound activation. The ShoutBox™ comes complete with hood with mesh front to avoid distortion of sound and carries CE certification. Fits adult-sized General Purpose, Haz-Mat and Multi-Trauma Manikins. Manikin not included.

23959510	ShoutBox™ Kit (ShoutBox and Hood)
23959511	ShoutBox™ Only
23959515	ShoutBox™ Hood



### SHOUTBOX GENERAL PURPOSE MANIKIN

The Shoutbox GP Manikin combines the original Ruth Lee General Purpose Manikin with the Shoutbox manikin voice box. It give an economical solution to interactive training.

#### Weight

239581020	Youth	44 lbs.
239581020A	Adult	44 lbs.
239581030	Adult	66 lbs.
239581050	Adult	110 lbs.

### FH TRAINING MANIKIN

#### All New Fire Resistant Design

The Fire House Manikins demonstrate a good balance between temperature and abrasion resistance. The Fire House manikin is perfect for fire and general training. The manikin carcass is constructed using heavy duty canvas, reinforced with 38mm Nomex webbing as opposed to the polypropylene webbing found on the general purpose range – standard Polypropylene webbing will go brittle and melt at the high temperatures this manikin is designed to withstand. The protective coveralls are constructed using a Nomex blend material which offers good protection against high temperatures - it is permanently non-flammable and most commonly used in protective clothing to protect against heat and flames. The protective coveralls are also reinforced using Nomex webbing to improve the abrasion resistance and strength – the overalls are fitted using 20mm Kevlar ties, as the standard Velcro fastening melt at these high temperatures. The ends of the arms, which have been identified as a high stress area, are reinforced with 5mm leather to provide extra protection. The Fire House Manikins are designed to withstand temperatures of 280-320°F (140-160°C), the average temperature at floor height for hot fire cell training and only starts to 'fail' at temperatures in excess of 350°F (180°C).

		Weight
23953120	Youth	44 lbs.
23953130	Adult	66 lbs.
23953150	Adult	110 lbs.
23953170	Adult	154 lbs.
23959830	Replacement FH Coveralls, Youth	
23959850	Replacement FH Coveralls, Adult	







### DIVE RESCUE / RECOVERY MANIKIN

*Designed for water victim recovery training.*

Constructed using a reinforced, heavy-duty Nylon mesh for the carcass with non-absorbent closed cell foam for buoyancy. The mesh allows the water to flood out of the body as it is being recovered and also allows better ventilation when the manikin hung up to dry. Polypropylene strips running from the shoulder area to the knee joint allow flexibility in and out of the water, but do not allow the dummy to bend in half when using stretchers or recovery devices like the Jacob's Cradle. The addition of the facemask and wig gives a realistic look and feel and aids the identification of a human body in poor visibility. The manikin has a dry weight of 110 lbs. (50 kg) out of the water and will sink quickly to the desired position. The closed cell foam adds to the buoyancy, giving a weight of 22 lbs (10 kg) in the water providing a realistic training weight for a body in the water. Supplied complete with user-replaceable boots and protective overalls to protect the manikin.

Only available in Adult, Black



Sonar image of Recovery manikin

239523040



### "LARGE GENTLEMAN" BARIATRIC TRAINING MANIKIN

*400 lbs of Realistic Flabby Performance*

Designed to achieve a 'fluidity of movement' that simulates an obese patient. The Large Gentleman is based around a 220 lb. General Purpose Manikin, the extra bulk is built up with several weighted layers separated by Nylon coated padding. Rather than just adding a 180 lb. 'lump', we have distributed the extra weight around the body in 170 x 1 lb. packets of steel shot (a very time consuming process!). The Nylon coating on the padding allows the different layers to slip and slide over each other creating a real feeling of 'flabby skin'. Includes Reinforced Coveralls and Boots AND Drag Sheet.

**Weight:** 400 lbs. approx. **Height:** 5' 11"

Ships via Motor Freight Only.

		Weight
23951180	Large Gentleman	400 lbs.
23951260	Enormous ED	573 lbs.
29963144	Bariatric Drag Sheet	



### MAN OVERBOARD MANIKIN

Built to the same tough construction standard as the General Use Manikin, the water rescue is built to simulate an unconscious victim in the water, floating at an angle of 45 degrees with just the head and shoulders above the water. The head is color-coded with a yellow "face". Strong plastic strips in the manikin run from the shoulders to the knee and maintain overall flexibility but don't allow the manikin to "flop" in half. The outer carcass is constructed of heavy duty open mesh reinforced with webbing.

**Adult:** 5'11" **Youth:** 4'3"



Manikin Hoodie

		Size	Color
23952040	Adult	88 lbs.	Orange
23952020	Youth	44 lbs.	Orange
23952041	Adult	88 lbs.	Black
23952021	Youth	44 lbs.	Black
23952049	SAR Hoody for Man Overboard Manikin		
23959691	Low-Viz Mesh Hood		



### TECH RESCUE CPR MANIKIN

Allows for realistic body-weight CPR training in more difficult situations (i.e. confined spaces or with the manikin trapped under a vehicle or collapsed building etc.) This manikin takes CPR / Medical training out of the clean, classroom environment and integrates it into a realistic technical rescue training situation. Can be placed into confined spaces, trapped under a vehicle or train, or under concrete or wooden beams etc; These are situations where rescuers might actually come across casualties, where they may not be able to move them into a 'convenient' position to carry out CPR. This manikin adds an additional dimension to technical rescue and CPR training. The torso isn't actually fixed to the manikin and can simply be lifted out for cleaning or maintenance. The chest cavity of the manikin is also padded to protect the CPR torso, when used in difficult situations. The torso is constructed of soft, realistic vinyl plastic over polyurethane foam. The manikin features the following:

- Long torso for realistic abdominal thrusts.
- Realistic head tilt and chin lift for opening airway.
- Anatomical landmarks including sternum and ribcage plus substernal notch.
- Easily manipulated airway to simulate airway obstruction or choking situations.

		Weight
23954221	Rescue CPR Manikin	56 lbs.



Includes Coveralls & Boots



Simulates Full and Partial Amputation of Leg and Arm

### MULTI-TRAUMA TRAINING MANIKIN

The Multi-Trauma Rescue Manikin evolved from the Blast and Impaled Victim manikin to combine all the features of these manikin in one product. Additionally, the head has been redesigned to allow the fitting of an extrication collar. So now you have in one manikin a General Purpose rescue manikin that can also simulate an amputated arm and leg, an impaled torso and a suspect neck injury. The hole on the left of the torso allows a spike to be firmly held in place. The right arm and right leg are fully detachable to simulate an amputation, or by partially releasing the locking straps the limb can be weakly attached and will fall off if the rescuer does not correctly assess and support the injury. The manikin is supplied complete with sturdy boots that greatly protect the legs if the manikin is dragged along the ground, and are user-replaceable if badly damaged.

Height: 5'11"

Multi-Trauma Training Manikin shown with C-Collar (not included), also Includes Coveralls (not shown).

	Weight
23956030	66 lbs.
23956050	110 lbs.



Shell is constructed with durable, water resistant PVC fabric that is webbing reinforced



Included Reinforced Coveralls are easily removed and replaced.

### HAZ-MAT RESCUE DECON MANIKIN

Heavy Duty, Water Resistant Outer Shell

The HazMat Rescue Training Manikin is based upon our popular General Purpose Training Manikin. Available in 66 lb. and 110 lb. models. The internal construction is basically identical to the General Purpose Manikin, but the HazMat Manikin has an outer carcass made from tough, nylon reinforced PVC. This material is designed to withstand being heavily doused with water during a chemical spillage exercise or laying in water during a storm water drain or cave rescue exercise. In fact, it is useful in any scenario where the manikin has to endure a constantly wet environment. The HazMat Manikin has no flotation so where scenarios are in deep water, the use of our Water Rescue Manikin is indicated. Supplied with a coverall of polyurethane coated polyester with polypropylene webbing in high stress areas. At the end of the exercise, simply hose down the whole manikin and hang up using the integral lifting look at the back. Includes replaceable reinforced coveralls and Lug-Sole Boots. Anatomical Head.

Height: 5' 11"

	Weight
23957130	66 lbs.
23957150	110 lbs.
23957170	154 lbs.



### TRAINING MANIKIN WEIGHT VEST

For Adult Training manikin

Special Low-Profile design fits underneath manikin coveralls.

Quickly and securely fitted to manikin. Allows one manikin to do the work of many. Now, both heavy and lightweight training needs may be met with a single manikin. (Shown outside of coveralls for clarity).

\*Nominal weight



	Weight
23959215	15 lbs.*
23959225	25 lbs.*
23959236	36 lbs.*



### THERMAL IMAGING TRAINING VEST

Vest designed to aid in thermal imaging training. Low profile design fits underneath coveralls of Manikin. (Shown outside of coveralls for clarity).

23959301	Thermal Imaging Vest
23959303	Thermal Packs, Set of 2



### CASUALTY TRAINING ARMBANDS

*Provides Identification of Injuries*

MCI casualty Armbands for Training manikins or patients used in drills. Includes one each: Head, Arm, Leg, Neck, Back, Chest.

23959501 Arm Bands, set of 6



### DRAG HARNESS FOR RESCUE MANIKIN

A Full Body Harness with added shoulder handles for use with the Training manikins. Fits all Adult Ruth Lee and Simulaids manikins.

718130 Manikin Drag Harness

### RANDY 9000

Designed to be customized by the user for optimal training use. Just add water, sand, or any other substance as long as you can empty the substance out of the parts. Empty manikin weight is less than 40 lbs. The range of motion of the joints, including bending at the waist, mimics real life. Perfect for RIT or Combat Challenge as well as ship-board, heavyweight, horizontal rescues or lightweight packaging exercises like spinal immobilization. Randy 9000 may be used in all weather conditions and the joint design protects rescuers' fingers. Each manikin component is easy to replace.



24039000 Randy 9000

### FLEXIBLE RESCUE RANDY

This standard-sized Rescue Randy unit has been developed especially for the aerospace industry and wing tank fuel cell rescue training, but it can be utilized in any confined space rescue. The waist flexes and the head twists to allow positioning of the manikin in tight spots. Flexible 5 ft. 5" Rescue Randy.

**Size:** 50" x 21" x 12" **Shipping Weight:** 60 lbs.

21542710 Flexible Rescue Randy



### MANIKIN STORAGE BAG

A custom-designed bag to fit the youth - Heavy Adult Sized RescueTECH Training Manikins. Features Heavy Duty PVC material and nylon straps. Includes shoulder straps and end lifting handles.

23959104 Storage Bag, Youth / Adult



### MANIKIN DRAG PROTECTOR

These leg protectors protect the manikins when being dragged - particularly during Firefighter drag training. Constructed using tough, heavy duty nylon with a disposable Polypropylene plastic strip. The plastic strip is held in place with 4 heavy duty snaps and will last for many exercises before needing to be replaced. Additional plastic strips can be bought in packs of 5. The leg protectors include a harness and two 'dragging' loops. It also include two loops to hold the manikins arms in place to prevent them dragging on the ground; polypropylene webbing and quick release buckles quickly and easily secure the leg protectors to the dummy.

23959310 Drag Protector, Complete

23959311 Replacement Protectors, set of 5

### RAPID INTERVENTION TRUSS

Designed with Rapid intervention Team (RIT) and confined space rescues in mind, this adjunct to the Rescue Randy eliminates strap pressure applied to the groin area of the Randy. Harness or waist straps that are passed through the groin during exercises will not hinder the structure of the manikin skeleton, which causes degradation of the pelvis. Use this inexpensive product to protect the investment you made in your Rescue Randy.

21541479 Randy Intervention Truss

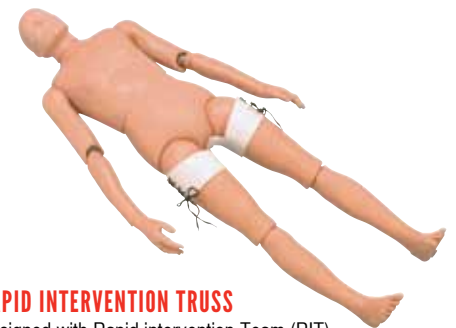





## RESCUE RANDY

### Official Manikin of the Firefighter Combat Challenge

Molded of durable vinyl plastic. Built with 4,200 lbf. test plastic coated cables. Articulated Joints. Weight distribution according to human weight distribution chart. Used by U.S. Military, Fire and Police Departments, Safety Teams, and Emergency personnel for rescue and extrication. Ideal for Tower, Confined Space and Trench Rescue.

			Weight	Height
21544175	Rescue Randy IAFF	#1475	165 lbs.	6' 1"
21544165	Rescue Randy Combat Challenge	#1435	165 lbs.	6' 1"
21544145	Rescue Randy Combat Challenge	#1434	145 lbs.	6' 1"
21545200	Rescue Randy, Large Body	#1437	200 lbs.	6' 1"
21545175	Rescue Randy, Large Body	#1436	175 lbs.	6' 1"
21545125	Rescue Randy, Large Body	#1433	125 lbs.	6' 1"
21545165	Rescue Randy, Standard Body	#1345	165 lbs.	5' 5"
24031344	Rescue Randy, Standard Body	#1344	145 lbs.	5' 5"
21544105	Rescue Randy, Standard Body	#1335	105 lbs.	5' 5"
21544055	Rescue Randy, Standard Body	#1338	55 lbs.	5' 5"
21541355	Rescue Jennifer	#1355	16 lbs.	4'
21541355R	Rescue Jennifer II	#1355S	38 lbs.	4'
21542094	Storage Bag, Combat Challenge	#2094		
21543100	Storage Bag, Rescue Jennifer	#3100		



## COMBAT CHALLENGE KID

Challenging children creates character. Put your kids to the test with this down sized version for the Fire Fighters Combat Challenge, kid style.

24031460 Combat Challenge Kid \$425.00

## WATER RESCUE TRAINING MANIKIN

Used by the U.S. Coast Guard, Sheriff's Departments, Lifeguard Trainers and Emergency Personnel for both on water and in water rescue and retrieval. Manufactured of durable vinyl plastic with rust resistant steel skeleton (adult and adolescent models). Articulated joints on Adult and Adolescent. When filled with water manikin will submerge to neck. Add an additional 5 - 10 lb. weight (not supplied) to sink.

			Weight	Height
A. 21541350	Rescue Cathy, Infant	Model# 1350	5 lbs.	20"
B. 21541352	Rescue Billy, 6 - 9 Month	Model# 1352	7 lbs.	25"
C. 21541351	Rescue Timmy, 3 Year Old	Model# 1351	10 lbs.	32"
D. 21541327	Adolescent	Model# 1327	22 lbs.	4' 0"
E. 21541326	Adult	Model# 1326	52 lbs.	5' 5"



## SIMULAIDS / I.A.F.F 50 LB. TRAINING WEIGHT VEST

A specially designed (with the assistance of the I.A.F.F.) weight vest to aid in firefighter physical ability testing. The 50 lb. vest simulates the weight of protective clothing and SCBA. Pouches on shoulders accept additional 25 lbs of weight to simulate hose bundle. New design offers better fit and greater comfort for firefighter.

	Size
21541118	Small
21541120	Medium/Large
21541125	XLarge
21541000	Extra Shoulder Wgts, 25lbs.



## BARITRIC RESCUE SUIT

The Bariatric Rescue Manikin Suit replicates the weight and the movement in body tissue associated with morbidly obese patients. This "exo-suit" allows the user to add up to 440 lbs. of water. When the exercise is complete, drain the water. In its dehydrated version, the manikin can be easily transported between locations. The Bariatric Suit fits only the Regular Rescue Randy original 5 ft. 5", bald manikins. For manikin use only.

24031500 Bariatric Rescue Suit

# EQUIPMENT BAGS & PACKS

## Stowable Padded Shoulder Straps

RescueTECH Shoulder Pads are produced with the highest quality structural webbing, soft and supportive foam, and breathable padding. The system stows in an integral compartment to keep the straps secure during storage; yet are easy to deploy when needed.



## USAR-TECH ROPE & EQUIPMENT PACK

A full backpack style equipment storage/carrier. Features a rope bag section with room for 200 ft. of 1/2" ACCESS Lifeline PLUS space for a pre-rig rescue system (or a single 300' length of ACCESS Lifeline). This feature is easily accessible without opening the main compartment. The main compartment features RescueTECH's exclusive "expanding compartment" storage system. The system effectively doubles the storage space for webbing, slings, and rope guards by placing a divider in the main compartment. Adjustable Shoulder and waist straps will accommodate all rescuers. Waist pads will actually expand to fit larger waists. The semi-rigid internal frame supports gear. All straps may be tucked into special storage areas to prevent tangling with other equipment in the compartment. Manufactured in our Georgia facility from fabric made from Dupont Cordura Brand fibers.

**Dimensions:** 20"h x 18"w x 10"d.



Rope and Pre-Rig Accessible from exterior through our rapid access opening



First equipment section opens to show webbing, sling, and rope protector storage section



Opening the divider reveals additional sling storage and mesh compartments for hardware and rigging supplies.



Breathable Padded Shoulder strap.



Equipment not included

	Color
808320	Orange
808326	Blue
808324	Red
808321	Black



## USAR-TECH II ROPE & EQUIPMENT PACK



An upgraded version of our original USAR-TECH Pack. We've added exterior zippered pouches to hold quickly needed equipment. The main compartment features RescueTECH's exclusive "expanding compartment" storage system. The system effectively doubles the storage space for webbing, slings, and rope guards by placing a divider in the main compartment. Adjustable Shoulder and waist straps. The semi-rigid internal frame supports gear. All straps may be tucked into special storage areas to prevent tangling with other equipment in the compartment. Manufactured in our Georgia facility. Available with 2 Interior storage styles - the original heavy duty mesh pouches or webbing equipment storage straps. Extremely durable YKK self-healing zippers and the highest quality side-release buckles for long term use. Holds 200' of 1/2" Access and pre-rig or 300' of 1/2" Access.

**Outside Dimensions:** 20" H x 22" W x 10" D **Interior Panel:** 19.5" H x 16.5" W



Mesh Pocket System: Original RescueTECH mesh equipment storage compartments.



Web Strap System: New webbing attachment panel with snap loops and equipment multiloop.



Exclusive Interior Expanding Storage may be detached to transport needed equipment

	Color		Color		
8083510	Mesh System	Orange	8083520	Web System	Orange
8083511	Mesh System	Black	8083521	Web System	Black
8083514	Mesh System	Red	8083524	Web System	Red
8083516	Mesh System	Blue	8083526	Web System	Blue



## USAR-OPS ROPE & EQUIPMENT PACK

Now in 2 Sizes

A slightly smaller version of our popular USAR Rope and Equipment Pack, the Standard Rescue pack is durable and versatile. 3 interior mesh pockets securely hold small items. Outside 'slash' pockets and full width interior pockets give ample storage space for rope pads, slings and webbing. Horizontal strap system allows for attachment of pulleys and carabiners. Standard size holds 200 ft. of 1/2" ACCESS Lifeline and the Large holds up to 300 ft. rope. The USAR-OPS Pack also accommodates a pre-rigged system in rope section. Padded shoulder straps and waist strap are comfortable and easily stowed for bag storage.

**Dimensions:** Standard: 20"H x 16"W x 10"D Large: 24"H x 16"W x 10"D



Side View:  
Padded Shoulder Straps and Slash Pocket

Back View:  
Stowed Shoulder Straps.

Interior View: multiple  
mesh pouches, attachment  
straps and slot pocket.

	Description/Color	Capacity
8083134	Standard/Red	200'
8083136	Standard/Blue	200'
8083131	Standard/Black	200'

	Description/Color	Capacity
8083144	Large/Red	300'
8083146	Large/Blue	300'
8083141	Large/Black	300'



## BASIC ROPE & EQUIPMENT PACK

Single Storage Compartment

A Downsized version of our Deluxe Rope & Equipment Pack. The Basic Pack features the same looped webbing storage panel of our deluxe but in a single pack compartment design. The pack has a webbing carrying-handle and padded contour shoulder straps. A false back stores the shoulder straps when not in use. A front outside compartment is 16"H x 12"W x 6"D. The compartment has a sleeve for a rescue rack.

**Weight:** 2.2 lbs.

Equipment not included.

	Color
808200	Orange
808204	Red
808206	Blue



## RESCUER EQUIPMENT PACK

A larger version of our Deluxe Equipment pack. Larger dimensions along with our Expanding Compartment Storage System gives rescuers extra room for needed equipment. 5 Mesh Pockets and 2 equipment loops. Padded stow-away shoulder straps. Self-Healing #10 industrial zipper.

**Dimensions:** 20"h x 16"w x 6"d.



Interior View: multiple mesh pouches,  
attachment straps and slot pocket.



Side View:  
Padded Shoulder Straps.



Back View:  
Stowed Shoulder Straps.

	Color
808344	Red
808346	Blue



## DELUXE ROPE & EQUIPMENT PACK

2 Compartments

An innovative pack designed to provide organized storage and convenient transport of rescue equipment. The main compartment (16"H x 12"W x 8"D) is fully padded with closed cell foam and has webbing loops to attach equipment. The pack has a webbing carrying-handle and padded contour shoulder straps. A false back stores the shoulder straps when not in use. A front outside compartment is 16"H x 12"W x 2"D. The main compartment has a sleeve for a rescue/rappel rack.

**Weight:** 2.2 lbs.

Equipment not included.

	Color
808300	Orange
808304	Red
808306	Blue



## WARNING

Technical rescue and safety is potentially hazardous. Any person using equipment sold by RESCUE TECHNOLOGY in any manner is personally responsible for learning the proper techniques involved, and assumes all risks and accepts full and complete responsibility for any and all damages or injury of any kind, including death, which may result from the use of any RESCUE TECHNOLOGY equipment.





### EQUIPMENT CACHE PACK



A handy storage pack for quickly needed rescue equipment. Padded sides, 4 Mesh Pockets, 8 equipment loops. Padded ergonomic shoulder straps store out of the way when not in use.

**Dimensions:** Closed: 23" x 12" x 4" Open: 23" x 24" x 2"

81133924 Equipment Cache Pack



### EQUIPMENT SADDLE BAG ORGANIZER



*Organizes Equipment*

A modular accessory for our rope bags. Organizes technical gear into a convenient deployment package. Fits our medium, large, and extra-large size rope bags. The Saddle Organizer pockets are 8" x 4" x 20" with #10 zippers and a clear vinyl window for inventory lists. External Mesh Organizers for quickly needed items.

**Weight:** 1.25 lbs.

Rope Bag not included.

		Color
808901	Equipment Saddle Bag Organizer	Black
808904	Equipment Saddle Bag Organizer	Red
808906	Equipment Saddle Bag Organizer	Blue



80899101	USAR
80899102	HAUL
80899103	MAIN
80899104	BELAY
80899105	RIGGING
80899106	RESCUE

### EQUIPMENT CACHE RESCUE SET



A compact set of equipment suitable for rigging anchor, haul / lower, and belay systems.

- Equipment Cache Pack (5) • RescueTECH Technical Rescue Rigging Plate (1) • H.D. Load Release Strap (2) • Oval Steel Carabiner, Screwgate (3) • RescueTECH Rope Pad, Wide (1) • RescueTECH 2.5" PMP (5) • RescueTECH Rescue Rappel Rack (5) • OD50 Rescue Carabiner, Screwgate (10) • 1" H.D. Flat Webbing x 12' (YE) (2) • 1" H.D. Flat Webbing x 20' (OR) (2)
- Presewn Prusik, 18" (YE) (5) • Presewn Prusik, 28" (RD) (2)



29983425 Equipment Cache Rescue Set

### PACK ID LABELS

RescueTECH Packs are now produced with an attachment system for ID Patches. Starting in June 2010, the USAR-TECH, USAR-TECH II, USAR-OPS, and the Deluxe and Basic Rope & Equipment Packs can be used with our ID Patches. The high quality embroidered panels can identify function, ownership, and much more. Panels may be changed when packs are repurposed. Custom Patches are available, call for Pricing.

*Compatible with the following packs\*:*

**USAR-TECH II • Deluxe Equipment • USAR-TECH • Basic Equipment • USAR-OPS • Rescuer Equipment**

\*Starting with 2010 Production



### PERSONAL GEAR BAG

Constructed with heavy-duty welded urethane bottom to prevent outside moisture from leaking in. The 1000-denier Cordura® upper closes with a heavy-duty zipper. Two generous zippered outside pockets and two large inside zippered mesh pockets help you keep smaller items organized. Comfortable carry handle, ergonomic shoulder strap, compression straps over the closure zipper and external D-rings and attachment loops round out the features of this great bag.

**Dimensions:** 25" x 15" x 14"

20843084 Personal Gear Bag



### USAR TASK FORCE MEMBER PACK

*A Multi-Use Personal Equipment Pack*

Designed at the request of a Southeastern USAR Team, the pack keeps Helmet, Class III harness, Carabiners, Webbing, Gloves, Accessory Cord, Goggles and other personal gear ready for deployment. Manufactured of High Strength Polyester fabric. Padded on all sides to protect contents. "D" rings on end accept shoulder straps. We can even fill it with the equipment that you need.

**Dimensions:** 24 x 12 x 10"



Equipment Not Included

29962101 USAR Member Pack  
809790 Shoulder Strap



### RESCUER GEAR BAG

We took the time to design a bag that a rescuer could keep personal gear ready to go. The main section has a zipper system that allow quick and full access to the contents. The large end pouch will hold an R3 Kiwi helmet, but can also be used for a change of clothes, harness, and other rescue items. The small end pouch works great for gloves, slings, etc. Side pockets hold other personal gear. A zippered see-through panel can be used for personal identification and allows the bag to be used and marked as a specific use rescue kit. Includes adjustable shoulder strap. Made in USA.

**Dimensions:** 24 x 10 x 10"

809741	Black
809744	Red



Equipment not included Includes Shoulder Strap



### RT DUFFEL BAG

A traditional cylinder bag built with the same high quality and durability as all of our rope and equipment bags. Manufactured from our RescueTECH™ super tough fabric. Seams are double-stitched and taped for superior strength.

Large: 20" x 12"	Color
8063140	Orange
8063141	Black
8063144	Red
8063146	Blue

Extra Large: 24" x 15"	Color
8063150	Orange
8063151	Black
8063154	Red
8063156	Blue
809790	Shoulder Strap, Adj



### RIVER RESCUE DUFFEL

Organize your river hardware into one convenient duffel. This bag was designed with the rescue professional in mind while addressing the needs of the larger boating community. Manufactured from 600 denier polyester material. Full-length zipper provides quick access to gear. The 3" deep end compartment makes for easy organization of smaller gear. Sturdy handle and shoulder strap made with webbing that includes 3M® reflective tape makes the bag easy to find in low light situations.

**Dimensions:** 30" x 16" dia.

208430864 River Rescue Duffel



### RT GEAR BAG

#### Heavy Duty Carrying Handles on Ends

A large Duffel design easily stores turnouts, helmet and boots. Great for all rescue personnel. The two-way wrap around zipper allows you to open bag all the way for easy access to contents. A large zipper pocket outside gives you extra storage for personal items, gloves, tools and goggles. Two inch webbed handles wrap completely around the bag to give extra support.

**Dimensions:** 12" x 16" x 24" **Color:** Red

**Weight:** 1.5 lbs.

809704 Gear Bag



### RT GEAR PACK

#### Stowaway Padded Shoulder Straps

Based on our popular Gear Bag design, we added shoulder straps to make it easier to move this pack around. Easily stores turnouts, helmet and boots. Great for all rescue personnel. Two-way wrap around zipper allows you to open bag all the way for easy access to contents. A large zipper pocket outside gives you extra storage for personal items, gloves, tools and goggles. Two inch webbed handles wrap completely around the bag to give extra support.

**Dimensions:** 12" x 16" x 24" **Color:** Red

**Weight:** 1.5 lbs.

809844 Gear Pack



(top) Upper Compartment with zippered mesh hood pocket and interior gear loop. Zip-Out divider. (red version shown)  
(bottom) Padded, Breathable Shoulder Straps and Back Panel, Carrying Handle. (red version shown)

### RESCUER PERSONAL PACK

Wide-Mouth Top Pocket makes it easy to see and access contents. Zip-Out divider shelf between top and bottom section lets you decide if you need 2 pockets or 1 large pocket. Zippered Mesh side Pockets and Inner Top Pocket. Padded shoulder straps with handle. Padded, breathable back panel with hydration bladder pocket. Interior Gear Loops. Integral ground tarp in lower compartment. Includes helmet Caddy.

**Dimensions:** 21" H x 13" W x 10" D **Capacity:** 1700 cubic in.

241210241 Rescuer Pack Color  
Black



### RIGGING BUCKET

#### Semi-Rigid Design

The newest bag from RescueTECH features semi-rigid sides to hold the bag open while loading rigging equipment and rope. Great for litter bridles and patient lashing as well as pre-rigged hauling kits. The main compartment has the same nylon fabric closure designed to keep the smallest items from escaping. 4 cordura pockets (with elastic closure) and 1 mesh side pocket for storing quickly needed equipment. Bottom is made from Ballistic Nylon for proven resistance to abrasion.

**Dimensions:** 12" high x 10" diameter.

803302 Rigging Bucket





### LANYARD POUCH

For lanyards, personal escape rope, gloves, and miscellaneous small equipment. Constructed of Cordura® nylon with fold over hook and loop closure. Built-in loops fit belts up to 4" wide. Holds 40 feet of 3/8" or 75 feet of 7mm nylon tag line or Titan Cord.

**Dimensions:** 8" x 5" x 3" **Color:** Black

**Weight:** 2.4 oz.

800101	Lanyard Pouch
--------	---------------



### NYLON STUFF SACK

Lightweight bags to stow small parts, equipment and personal gear. Manufactured of 200 den pack cloth with drawstring closure. Close with spring-loaded cordlock.

**Color:** Blue

	Size	Dimensions
805216	Small	10.5" x 4.5"
805316	Medium	12.5" x 5"



Equipment not included

### SWIFTWATER TEAM MEMBER DUFFLE

A tough, heavy-duty duffel. Sturdy 600 denier polyester forms the bottom and ends of the bag to protect your gear from sand and grit, and will endure years of abuse. High-strength mesh allows wet gear to dry, reducing mildew other moisture-related problems.

**Color:** Blue

	Size	Dimensions
807231	Medium	24" x 12"
807241	Large	30" x 16"



### DELUXE LANYARD POUCH



Great for search kits. A larger version of our popular Lanyard Pouch. The Deluxe Lanyard Pouch features a "hinged" lid with a "hook and loop" closure. Holds up to 80 ft. of 8mm cord.

**Dimensions:** 11" H x 7" W x 3" D **Weight:** 3 oz.

	Color
8001151	Black
8001150	Orange



### MESH STUFF SACK

This unique and versatile stuff sack has all of the advantages of a mesh bag with the durability of a nylon bag. Great for organizing gear or storing anything that you need to see.

	Size	Dimensions
22821452	Small	5" x 8"
22821453	Medium	6.5" x 12"
22821454	Large	8" x 15"
22821455	XLarge	10" x 18"
22821456	XXLarge	18" x 27"



### DRY BAG

Tough 21 oz. PVC fabric makes this bag the ideal storage system for rescue equipment. Bag handle and straps are welded to the bag with a heavy-duty double patch system. StormStrip Closure ensures the most waterproof seal on the market.

**Dimensions:** 25" x 14"

	Color
208429106	Blue
208429102	Yellow
208429104	Red



Equipment not included

### WATER RESCUE TEAM MEMBER BAG

A new, versatile bag for both Surface and Dive Rescue Team Members. Manufactured with side panels of strong Vinyl Coated Nylon mesh, this bag allows for excellent content ventilation. Front panel, zippered mesh-backed pockets hold fins, gloves, snorkels, and other personal gear. Interior compartment is large enough to hold Drysuit, PFD, helmet, Boots, and throw bag. Side compression straps. Top handle and Shoulder Strap D rings.

**Dimensions:** 26" x 18" x 10"

807542	Rescue Team Member Bag
809790	Padded Shoulder Strap



(left) T2 Rescue Pack shown with optional "Rescue" label  
(above) T2 Rescue Pack with stowable straps

### T2 RESCUE PACK

Durable pack works well as a personal equipment pack or rescue systems pack. Originally developed as a component to one of our rescue kits, this pack will hold the hardware and 300' of 3/8" rope used in our Tower Rescue Set.

**Medium:** 20" x 12" x 4" (960 cl / 16 l) **Large:** 24" x 14" x 8" (2688 cl / 44 l)

- Heavy Duty PVC coated Fabric • Molded "suitcase" handle on side • Stowable shoulder straps
- Haul Loop / handle on top end • "Daisy Chain" Equipment Storage Loops • Lid closes with quick-lock buckle • Interior collar closure keeps equipment inside • Interior equipment tarp keeps contents separated and ready to use • Accepts RescueTECH Pack I.D. Labels

		Color	Size
8088144	T2 Rescue Pack, Med	Red	Medium
8088164	T2 Rescue Pack, Lg	Red	Large



### BASIC SCBA MASK BAG

A basic, envelope-style SCBA mask Bag. Made from highest quality 300 x 600 PVC coated nylon fabric for durability and water resistance. Full width hook and loop fastener keeps the contents clean and ready for use. Steel ring allows firefighter to attach this bag to turnout gear with a simple key-ring carabiner. Fits most mask-regulator style SCBA Masks (Scott®, Interspiro®, etc.) Bags may be ordered with embroidery (25 unit minimum). Call for details.

**Dimensions:** 14" x 10" x 4" **Color:** Red

8321015	Basic Mask Bag
---------	----------------



### DELUXE SCBA MASK BAG

An upgraded version of our original envelope-style Basic SCBA Mask Bag. We have added structural fire rated Scotchlite Retroreflective stripes to the bag to increase visibility. Shell made from the highest quality pvc coated nylon fabric for durability and water resistance. Full width hook and loop fastener keeps the contents clean and ready for use. Steel ring allows firefighter to attach this bag to turnout gear with a simple key-ring carabiner. Fits most mask-regulator style SCBA Masks (Scott, Interspiro, Ect.)

**Colors:** Red w/ Yellow/Silver Stripes; Yellow with Orange/Silver Stripes

**Dimensions:** 14" x 10" x 4"

	Color
832102520	Yellow w/ OR/SI Stripes
832102542	Red w/ YE/SI Stripes



### HALL COUNTY SCBA MASK BAG™

After many months of searching and evaluation, Hall County Fire (Georgia) decided upon this design to protect their SCBA masks. Made of durable 1000d Cordura™ fit their needs to a "T". Closed with a durable #10 Zipper instead of Velcro™ for a long service life. Hall County chose to line the interior with a smooth, coated 200 denier nylon fabric instead of a fleece material. Their evaluations concluded that while the fleece was soft, it trapped dirt and contaminant in the material and between the inner and outer layer. Features a bottom grommet for drainage and a hook and loop strip to attach name plates or accountability tags. A durable 1" wide nylon webbing loop allows the bag to be attached to turnout gear or hooks in the apparatus or equipment lockers.

**Dimensions:** 14" x 7"

		Color
8321014	Hall County SCBA Mask	Red
83210146	Hall County SCBA Mask	Blue

# WATER RESCUE

## GEAR & PERSONAL PROTECTION



Water Rescue, whether swiftwater, lake, ice or ocean, is demanding on the rescuer and equipment. We have put together an selection of equipment that will help teams meet the most difficult rescue head on. From wet and drysuits to helmets to throwbags, RescueTECH can fill you equipment requirements.



### FIRST RESPONDER WATER RESCUE SET

Includes equipment most often required for swiftwater rescue classes.

- Universal Rescuer PFD (1) • ATB Rescue Boots (1 pair) • Lightweight Water Rescue Glove (1 pair)
- Throwbag 70" (1) • Fox 40 Rescue Whistle (1) • River Rescue Short Knife (1) • Havoc Water Rescue Helmet (1)

*Deluxe Set Includes (shown below in box): Water Rescue Team Member Bag (1) • Shredder Fins (1 pair)*



- |          |          |
|----------|----------|
| 29982001 | Standard |
| 29982002 | Deluxe   |

### BASIC WATER RESCUE SET

The bare minimum equipment to have while working around water.

- c-Vest PFD (1) • 3/8" Throwbag x 50 ft. (1) • River Rescue Short Knife (1) • Fox 40 Rescue Whistle (1)



Whistle Lanyard Not Included

- |          |                        |
|----------|------------------------|
| 29982003 | Basic Water Rescue Set |
|----------|------------------------|





### UNIVERSAL RESCUER

Universal Sizing fits 30 - 56" Chest

Features over-the-shoulder integral webbing reinforcement, a USCG approved rescuer's harness, and reflective tape on the shoulders and across the back.

**Design Flotation:** 23 lbs.

USCG Approved, UL Listed Type V PFD

	Color
350632	Yellow
350634	Red



### NRS RAPID RESCUER

Type III/V PFD. With 22 lbs of flotation, adjustable to fit chest sizes from 30 to 58 inches, and all the features you will ever need in a rescue vest. Two huge front pockets stretch to hold anything from a GPS to a VHF. Three lash tabs on the front are great for a knife, whistle or anything else you need to keep handy. A rear D-ring, strobe holder, and tether attachment round out the attachment points on the front with a safety light stick holder on the back and reflective tape everywhere. 8 adjustment points to ensure a secure fit.

	Color/Item Description
208421492	Yellow
208421494	Red
20842163	Leg Straps, Pair



### SWIFTWATER RANGER

The most buoyancy available in a rescue PFD. It's high back, padded shoulders, and long length offer exceptional protection when swimming rapids. The choice of swiftwater rescue teams nationwide. Quick-release belt.

**Design Flotation:** 24 lbs. 7 oz. - 26 lbs. **Weight:** 12 oz.

**Size:** M (40"-44"), L (45"-49"), XL (48"-52")

USCG Approved, UL Listed Type V PFD

	Color
3503X2	Yellow
3503X4	Red



### SWIFTWATER FURY

Highest flotation available in a short PFD, with ultra-soft foam for remarkable comfort and mobility. Designed for rescue units that need its unique combination of high buoyancy and short length. Features a loop strip over the shoulder to attach various accessories. Quick-release belt.

**Design Flotation:** 22 lbs. - 22 lbs. **Weight:** 13 oz.

**Specify Size:** M (40"- 42"), L (43"-45"), XL (46"-48")

USCG Approved, UL Listed Type V PFD

	Color
3502X2	Yellow
3502X4	Red



### UNIVERSAL HI-FLOAT

#### Universal Size high flotation vest

The U22 fits chest sizes from 30 - 56 inches. Its generous divided side pockets, external D-rings, and lash tabs allow attachment of multiple accessories. A 3 buckle closure system, generous reflective tape and 8 adjustment points create an excellent high-flotation option for water rescue and support teams.

**Design Flotation:** 23 lbs.

USCG Approved , UL Listed Type III PFD

	Color
350734	Red



### TYPE V PFD

#### Universal Size high flotation vest

The Type V is a high flotation jacket with a universal fit that wraps easily around anyone's torso. Four front buckles make entry, exit and adjustment simple and quick. Universal Plus fits: 30" - 58" chest. Six side adjustments and two shoulder adjustments hold the PFD securely in place. Flotation collar helps keep your head above water while floating on your back.

**Design Flotation:** 25 lbs.    **Size:** Fits 30" - 58" chest

	Color
208412520	Orange
208412522	Yellow
208412524	Red



### FORCE 6 RESCUER

The Force 6 is a high buoyancy (26lbs) vest for rescue professionals involved in boat and shore operations or medium to high risk swift water environments. Designed to meet the Personal Protective Equipment (PPE) needs of rescuers that face the challenges of moving water, these IRIA Certified vests are made of rugged, high visibility rip stop nylon and contain extra flotation to combat the reduced buoyancy effects of turbulent water.

An integrated structural harness and single piece over-the-shoulder foam design provide extra strength, structural integrity and body protection. Multiple adjustment points provide a secure fit that prevent ride up and a "live bait" quick release belt helps the rescuer to escape dangerous situations. Fast Tabs on both shoulders act as easy attachment points for accessories such as knives, scissors or strobe lights.

	Size
237011034	M/L
237011054	XL



### cVEST PFD

cVest Life Jacket has lots of reflective tape and a cool mesh back that works great with high-back seats. Six pockets, including one for a radio, provide lots of handy storage. An accessory lash tab and lanyard loops on the front, plus a beacon loop on the back, give you even more options for outfitting this vest. Flotation is concentrated up front and behind the shoulders, with a mesh lower back that lets you recline, relax and stay cool. SOLAS reflective tape on front and back provides outstanding low-light visibility. Eight adjustment points ensure a snug, secure fit. Large arm openings allow for unobstructed movement while paddling or rowing.

**Design flotation:** 16.5 lbs.

	Size	Color		Size	Color
20844002820	SM/M	Orange	20844002824	SM/M	Red
20844002840	L/XL	Orange	20844002844	L/XL	Red
20844002860	XXL	Orange	20844002864	XXL	Red



## MUSTANG HIT INFLATABLE PFD

### Hydrostatic Auto-Inflation

For severe weather, no premature inflation, low maintenance. The Auto Hydrostatic Inflatable Personal Flotation Device (PFD) will only automatically inflate when submerged in 4 or more inches of water and not prematurely due to rain, spray or humidity. No inflator maintenance is required for 5 years unless the PFD has been inflated. Inflator status and replacement date viewed through the safety inspection window. Constructed of durable 420-Denier nylon and heavy duty polyurethane coated nylon. Lightweight and comfortable, the PFD can be worn over a T-shirt or jacket. It is low profile and allows for the maximum amount of mobility. The neoprene Comfort Collar™ is so soft it won't chafe your neck. USCG Type V.

204931834	HIT, Red/Black
204931831	HIT, Charcoal/Black
20497214	HIT Re-Arm Kit



## K-9 PFD

### Canine Flotation Device

Whether your dog jumps or falls in the water, the Canine Flotation Device (C.F.D.) keeps them on the surface. With a tough 1000-denier Cordura® shell and heavy-duty straps, the C.F.D. can take the worst your dog can dish out! With the flotation on the back, your dog stays cooler. Wide, soft under-straps for comfort; durable grab loop and leash ring for security. A zippered pocket for a leash, snacks, etc. Reflective safety tape for visibility.

	Size	Chest	Weight	Flotation
208421402	S	22"-28"	20-40 lbs.	3.4 lbs.
208421403	M	26"-30"	40-60 lbs.	4.9 lbs.
208421404	L	30"-37"	60-80 lbs.	6.4 lbs.
208421405	XL	36"-41"	> 80 lbs.	7.9 lbs.



## WATER RESCUE TOW TETHER

Constructed of Heavy Duty Tubular Webbing, elastic, and steel ring. One end has a 2" ring to attach to the waist strap of Rescue PFD's. The other end is attached to a lightweight non-locking aluminum carabiner.

351101	Short Tether (35" Max)
351105	Long Tether (54" Max)



## LONG TOW TETHER, AUTOLOCKING

Constructed of Heavy Duty Tubular Webbing, elastic, and steel ring. One end has a 2" ring to attach to the waist strap of Rescue PFD's. The other end is attached to our Forged Aluminum Autolocking Snap with eye for extra security.

351205	Long Tow Tether
--------	-----------------



## JUMBO MESH PFD BAG

The Mesh PFD Bag makes it easy to transport and store your damp and difficult-to-carry gear. The top of this bag is made with the same 2-1/2" square mesh netting so that everything inside dries quickly. The bottom is 500 denier PVC for durability. Two sturdy handles and a quick-cinch draw cord opening allow you to pick up and go. Room enough for all your friends' gear, too. Holds up to 18 PFDs.

**Dimensions:** 40" W x 40" L x 30" H

20843094	Jumbo Mesh PFD Bag
----------	--------------------



## DELUXE MESH PFD BAG

Made for storage and transporting PFD's, the Deluxe Mesh PFD Bag is made from polyurethane coated mesh. The bottom is durable PVC coated nylon mesh for durability. Two sturdy handles are included and makes this bag extremely portable. Holds up to 10 Full sized PFDs(not included).

**Dimensions:** 35" L x 24" W x 18" H

Equipment not included

8063282	Deluxe Mesh PFD Bag
---------	---------------------





### EXTREME SAR DRYSUIT

Energlo arms help for low or no light conditions. 400-denier TriTon fabric will hold up to years of abuse. Cordura® exterior material reinforces seat, elbows and knees for rugged protection in high-wear areas. Neoprene padding in the elbows and knees provide extra protection while working in the field. Liquid neoprene coating protects latex wrist and neck gaskets from UV rays. TriTon fabric socks. Internal suspenders. Self-draining thigh pocket and a splash proof arm pocket. Heavy-duty YKK® waterproof men's relief zipper and entry zipper seals out water. Neoprene outer cuffs with adjustable hook-and-loop closures on the neck, wrist and ankles protect the latex gaskets. Reflective material on the wrists and piping. Pull cord waist adjustment allows for a more custom fit.

	Size
2084225353	M/L
2084225355	XL/XXL
2084225356	Grizzly

	Size	Height	Weight
	M/L	5'5" - 6'0"	130 - 195 lbs.
	XL/XXL	5'5" - 6'4"	185 - 245 lbs.
	Grizzly	5'11" - 6'4"	260 - 305 lbs.



Size	Height	Weight
S	5'2" - 5'6"	115 - 140 lbs.
M	5'6" - 6'0"	140 - 175 lbs.
L	5'10" - 6'2"	175 - 200 lbs.
XL	6'0" - 6'4"	200 - 240 lbs.
XXL	6'4" - 6'6"	220 - 260 lbs.

### EXTREME RELIEF DRYSUIT

#### Relief Zipper and Triton Socks

Utilizing 420-denier 3-layer TriTon™ fabric, makes the Extreme Drysuit rugged, waterproof and highly breathable. Heavy-duty YKK waterproof zipper across the body, plus extra-tough latex wrist and neck gaskets. Reinforced Cordura® seat, elbows and knees. Neoprene outer cuffs with adjustable hook-and-loop closures on the neck, wrist and ankles help keep you warm and protect gaskets from tough use. Reflective arm strips and shock-cord waist adjustment.

	Size
20842251X	S-XL
208422516	XXL



### FRONT ENTRY DELUXE DRYSUIT

#### Breathable GORE-TEX® Technology

3-Layer GORE-TEX® IMMERSION® Technology fabric is completely waterproof, breathable, and durable. Tightly woven fabric is tough as nails, yet quiet and comfortable. Complete with Gore-Tex® booties, Relief Zipper, Latex gaskets, neoprene trim, metal tooth waterproof zipper. 500 den Cordura® seat and knee patches. Self-draining pockets. For Rescue Tech by Kokotat.

Color: Mango/Cobalt.

	Size
2309012X	S-XL
23090126	XXL

Size	Height	Weight
S	5'2" - 5'6"	115 - 140 lbs.
M	5'6" - 6'0"	140 - 175 lbs.
L	5'10" - 6'2"	175 - 200 lbs.
XL	6'0" - 6'4"	200 - 240 lbs.
XXL	6'4" - 6'6"	220 - 260 lbs.



### T3 SWIFT ENTRY DRYSUIT

#### Basic Swiftwater Drysuit

A rugged dry suit at an economical price. This popular drysuit is now built with waterproof, breathable Tropos fabric. The Swift-Entry has an adjustable waistband to allow for custom fit. Neoprene cuffs over latex gaskets at wrists and ankles, plus reinforced knees and seat, ensure long life. YKK metal-tooth zipper.

Sizes: S-XXL Color: Cobalt/Black

### T3 SWIFT ENTRY W/ RELIEF ZIP

The basic style T3 Swift Entry drysuit is now available with a front relief zipper.

Sizes: S-XXL Color: Cobalt/Black

T3 Swift Entry	Size
208422522	S
208422523	M
208422524	L
208422525	XL
208422526	XXL

T3 Swift Entry w/ relief zip	Size
2084225362	S
2084225363	M
2084225364	L
2084225365	XL
2084225366	XXL



### ANKLE WEIGHT SET

For Use with Drysuits

Fully adjustable length with quick-release buckle for safety. Neoprene. Sold in pairs.

Color: Black Weight: 4 lbs. (2 lbs. each)

46001521 Ankle Weight Set



### MUSTANG WATER RESCUE DRYSUIT

The Mustang 576 is the next evolution of Mustang Survival's constant wear "cache" dry suit. This suit is ideal for cache equipment. This suit includes:

- YKK metal entry zipper
- Comfort fit relief opening
- Closed comfort system AS neck seal
- Reinforced wrist and ankle overcuffs with Velcro® closures for adjustability
- 1050 Denier ballistic nylon wear protection
- Two-point attachment removable suspender system for an improved fit, mobility and comfort
- GORE-TEX® waterproof & breathable dry suit fabric
- Integrated GORE-TEX® dry socks (size XL+ come with jumbo socks)
- Adjustable waist band
- SOLAS retro-reflective tape on the arms for increased visibility
- Reinforced knee pads and elbow pads help prevent injury
- Nylon reinforced seat

	Size
204904576322	S
204904576332	M
204904576342	L
204904576352	XL
204904576362	XXL



### ICE COMMANDER RESCUE SUIT

The suit of choice for Coast Guard, SAR, Fire, and all Ice Rescue Professionals. Its Integral chest harness, ice awl pockets, gloves, reinforcements and non-slip soles keep you prepared for any emergency. Highly visible welded nylon shell and removable AirSoft™ foam liner. It's 45% lighter than conventional neoprene suits, giving maximum flexibility and performance.

Size: Adult Universal Body Mass: 110 - 330 lbs.

Height: 4'11" - 6'7" Color: Yellow

20499000	Ice Commander Rescue
20492001	Replacement Bag
2049228202	Replacement Liner
20492290	Repair Kit



### COLD WATER IMMERSION SUIT

Designed for use in commercial operations, the new Immersion Suit from Mustang Survival is the ideal ship abandonment suit for workboats, transport vessels, drilling rigs, supply ships, steamships and commercial fishermen. Also suitable for the sailing community. Color-Coded storage bags indicate sizing.

- Easy to don in stormy conditions
- Five-fingered insulated gloves
- Inflatable head pillow give optimal float angle
- Water-tight face seal
- Wrist and ankle adjustments for a better fit
- 5mm fire retardant neoprene
- Triple-sealed seam construction
- SOLAS grade reflective tape
- SOLAS grade hailing whistle
- Light Pocket fits a variety of SOLAS lights
- Non Slip, durable soles on foot bottom.
- USCG approval PENDING; SOLAS compliant
- Includes use and inspection manual
- Includes tube of zipper lubricant

	Size	Bag Color
204923030	Universal Size	Orange
204923024	Adult Small	Red
204923055	Adult Oversize	Green
204923012	Child	Yellow



## STANDARD RESCUE WETSUIT

### Front Zipper

A full-coverage suit. 3 mm Dupont® neoprene provides insulation, while PowerSpan™ panels on the shoulders, back and arms increase mobility. Zippers on wrists and ankles for easy exit from the suit after a long day. Textured raw neoprene friction zones on the sides help lock a PFD in place. 5 mm seat for extra padding is covered with ToughTex™ for durability. Molded polyurethane knees and shins for long wear and extra protection. Reflective Lettering and Bright Yellow Panels Color: Yellow/Black. Grizzly Version provides extra room in the chest and waist area.

	Size
208422132	Small
208422133	Medium
208422134	Large
208422135	XLarge
208422136	XXLarge
208422137	XXXLarge
	Grizzly
2084221G4	Large
2084221G6	XXLarge



## FARMER JOHN / FARMER JANE

Just the essentials, at a great price. The same proven design as the 2.5mm Farmer John, but crafted with thicker 3.0mm neoprene.

• 3.0mm neoprene forms the base and is protectively backed with comfortable nylon on both sides. • Large arm holes assure you full freedom of movement. • Extra-long, double-pull YKK® front zipper for easy entry and relief. • Armored seat and knees have reinforced padding for extra durability and protection. • Zippered ankles make it easy to get over booties.

Farmer John	Size
208422243	M
208422244	L
208422245	XL
208422246	XXL
208422247	XXXL

Farmer Jane	Size
208422251	XS
208422252	S
208422253	M
208422254	L
208422255	XL
208422256	XXL

## GRIZZLY FARMER BILL

Big folks know finding the right size in water gear can be a bear. The Grizzly wetsuit is extra roomy.

• Features 3-mm Neoprene for superior insulation. • Cut large around the chest, waist, thighs and calves. • Combines the convenience of a full-length front zipper with roomy, over-the-shoulder Farmer Bill-style suspenders. • Color: All sizes are black - shoulders are color coded by size.

	Size
20842219G3	Medium
20842219G4	Large
20842219G6	XXLarge
20842219G8	XXXLarge



Men's



women's



Grizzly

## 2MM WETSUIT JACKET

Combine the 2mm neoprene Wetsuit Jacket with any of our other wetsuits for maximum warmth in your arms and torso. The Grizzly Wetsuit Jacket gives the greater girth needed by the barrel-chested boater. Pair these items with matching Farmer John suits for the ultimate warmth and comfort. 2mm neoprene with Titanium laminate adhesive increases warmth without adding excess bulk. PowerSpan™ under the arms gives you plenty of mobility. The extended waist and raised collar give you superior coverage and increased warmth and comfort. YKK® wrist and full-front zippers provide easy, trouble-free entry.

	Size
208422103	M
208422104	L
208422105	XL
208422106	XXL

Grizzly	Size
20842210G3	M
20842210G4	L
20842210G6	XXL
20842210G8	XXXL

## 2MM SHORTY WETSUIT

The Little John and Little Jane Shorty Wetsuits give you a great combination of warmth and comfort. The cut allows more freedom of movement, while 2mm Terraprene™ neoprene provides essential core insulation without unnecessary bulk. Generous armholes give you excellent range of motion. Durable flat-lock seams lie flat on your skin for greater comfort. • 2mm neoprene retains core body heat and offers cushioning. • Short-cut legs give increased freedom without sacrificing core warmth. • Featuring a full-length, double-pull front zipper for ease of entry and relief.

Men's	Size	Women's	Size
208422173	M	208422161	XS
208422174	L	208422162	S
208422175	XL	208422163	M
208422176	XXL	208422164	L
208422177	XXXL	208422165	XL

Grizzly	Size
20842217G3	M
20842217G4	L
20842217G6	XXL
20842217G8	XXXL





### WAVELITE UNION SUIT

10 oz polyester/Spandex blend for a mid-weight insulating layer with excellent stretch. Soft terry liner and flat-stitched construction for comfort. Wear the Union Suit for a toasty, draft-free base layer under your drysuit. Double-pull zipper with protective inner flap.

Specify size: XS - XXL

	Size
208426412	S
208426413	M
208426414	L
208426415	XL
208426416	XXL



### DRYSUIT UNDERGARMENTS

The next generation of next-to-the-skin layering garments. Made from anti-microbial fabric for warmth, comfort and breathability. These high performance pieces are designed to provide a comfortable, wicking first layer under clothing, drysuits, and wetsuits. Midweight made from Polyester and Lycra. Heavy-Weight is 100% polyester fleece.

		Size
20842550X	Mid-Weight Pants	S, M, L, XL
208425506	Mid-Weight Pants	XXL
20842551X	Mid-Weight Shirt	S, M, L, XL
208425516	Mid-Weight Shirt	XXL
228256338X	Heavy-Weight Pants	S, M, L, XL
228256337X	Heavy-Weight Shirt	S, M, L, XL



### LONG SLEEVE RASH GUARD

The Long Sleeve Rash Guard is made from an 8-oz. material that increases wicking keeping you dryer and more comfortable. Great for use as a solo layer when the weather gets warm, great base layer when it's cold, and for underneath wetsuits. The fabric has a sun protection factor (UPF) of 50. Snug Fit for easy layering. A silky outside and soft-brushed inner feels great against the skin.

Men's	Size	Color
20842601126	Small	Blue / Blue
20842601136	Medium	Blue / Blue
20842601146	Large	Blue / Blue
20842601156	XLarge	Blue / Blue
20842601166	XXLarge	Blue / Blue

Women's	Size	Color
20842603126	XSmall	Blue / Gray
20842603136	Small	Blue / Gray
20842603146	Medium	Blue / Gray
20842603156	Large	Blue / Gray

### WETSUIT SIZING

Size	Height	Weight
<b>Men's</b>		
Small	5'2" - 5'6"	115-140 lbs.
Medium	5'5" - 5'8"	135-165 lbs.
Large	5'7" - 6'0"	150-195 lbs.
XLarge	5'10" - 6'2"	185-225 lbs.
XXLarge	6'1" - 6'4"	215-245 lbs.
XXXLarge	6'3" - 6'5"	230-255 lbs.
XXXXLarge	6'4" - 6'6"	245+
<b>Women's</b>		
XSmall	4'8" - 5'2"	90-115 lbs.
Small	5'1" - 5'6"	110-135 lbs.
Medium	5'5" - 5'8"	130-155 lbs.
Large	5'7" - 5'10"	150-180 lbs.
XLarge	5'9" - 6'0"	175-210 lbs.
XXLarge	5'11" - 6'2"	200-220 lbs.
<b>Grizzly</b>		
G-Med	5'5" - 5'9"	200-235 lbs.
G-Large	5'8" - 6'0"	230-265 lbs.
G-XXL	5'11" - 6'4"	260-305 lbs.
G-XXXXL	6'3" - 6'6"	275-320 lbs.



### .5MM HYDROSKIN NEOPRENE SHIRT

The most comfortable piece of neoprene you will ever wear. Individual models cut and designed for men or women this HydroSkin™ shirt will keep you warm on cold water days, and makes a great base layer for cold weather. Made from HydroSkin's 0.5-mm Terraprene™, the shirt helps hold in heat without restricting your movement. ThermalPlush™ inner lining increases insulation, repels moisture and dries quickly. 4-way stretch PowerSpan™ outer layer allows easy, unrestricted mobility. Lycra underarms eliminate binding, adding to this top's superior function either as a single outer layer or as a base layer.

Men's		Color
20842620XGY	Men's Short Sleeve	Gray/Red
20842621XBL	Men's Long Sleeve	Blue/Gray

Women's		
20842622XBL	Women's Short Sleeve	Blue/Blue
20842623XBL	Women's Long Sleeve	Blue



### HELMET LINER

Much of your body heat escapes through the top of your head. Protect yourself with the NRS Mystery Side Cut Helmet Liner. Under your helmet this liner will keep you warm and comfortable. 1mm of neoprene provides the core insulation for this helmet liner. The GlideSkin™ exterior reduces evaporative cooling, increasing heat retention. Titanium laminate adhesive reflects and retains body heat for superior warmth. Lined with soft ThermalPlush™ fabric for all-day comfort.

	Size
208420263	Full Cut SM/MD
208420264	Full Cut L/XL
208420273	Side Cut SM/MED
208420274	Side Cut L/XL



### LIGHTWEIGHT WATER RESCUE GLOVE

Lightweight, durable glove for all rescuers. 2mm Neoprene on back for lightweight comfort & protection. Palm and fingers of reinforced Amara for durability. Stretch elastic band with Velcro closure.

**Size:** XS, S, M, L, XL, XXL

**23703341X** Lightweight Water Glove



### WARM WATER RESCUE GLOVE

1.5mm short cuff neoprene glove stretches to keep you in touch with your equipment. Durable GripCote™ palm ensures a solid grip and improved performance. Wristband helps seal out water.

**Size:** XS, S, M, L, XL, XXL

**20842417X** Warm Water Glove



### PADDLER GLOVE

The Paddler's Gloves offer the best combination of durability, warmth and paddle feel. Tough armored patches provide unmatched protection for paddling, rowing and rope handling. The back of the hand is 2-mm Terraprene™ neoprene for warmth, with added 3-mm pads for extra protection. The palm and fingers are constructed of rubberized, armored synthetic leather that gives excellent grip and durability. GripCote™ coating on palm and fingers provides excellent grip and added durability. Wristband cinches tight with hook-and-loop closure.

	Size
<b>208424401</b>	XSmall
<b>208424402</b>	Small
<b>208424403</b>	Medium
<b>208424404</b>	Large
<b>208424405</b>	XLarge
<b>208424406</b>	XXLarge



### SEAL SKINZ SOCKS

A three-layer, waterproof and breathable sock that fits perfectly under any river shoe or sandal.

**Size:** S-XL

**20842350X** Seal Skinz Sock



### COLD WATER DIVE HOOD

Cold water diving hood with bib. One of the most comfortable and best fitting hoods on the market. 7mm neoprene, 4mm skin-in face seal & 3mm Nylon II bib. Vent at top of hood releases excess air. Face area left unbound for custom trimming.

**Size:** (SM, M, L, XL, XXL)

**23700116X** 7mm Hood

### COOL WATER DIVE HOOD

1.5mm nylon II neoprene. Face area left unbound for custom trimming.

**Size:** (SM, M, L, XL, XXL)

**23709221X** 1.5mm Hood



### STORM PRO WATER RESCUE HELMET

A great new helmet for water rescue. The Storm's shell is a strong but light ABS plastic with a firm foam lining for comfort and shock absorption. Storm also features an adjustable ratchet system ensuring perfect comfort and fit every time you put it on.

**Color:** Yellow, Red, White

Certified to CE En 1385 Helmet Standards.

	Size	Dimensions
216170503X	Small/Medium	20.9" - 23.3"
216170505X	Large/XLarge	21.6" - 24.0"



### CASCADE WATER RESCUE HELMET

Multiple impact polypropylene, patented liner system. Closed cell foam won't absorb moisture. 4 point chin strap. 13 ventilation / drain ports. Stainless Steel hardware.

**Weight:** 17.6 oz.(M) **Colors:** Red, Yellow, White

	Size / Item Description	Dimensions
48042X	Small	21.6" - 22.25"
48043X	Medium	22.5" - 23"
48044X	Large	23.25" - 23.75"
48045X	XLarge	23.75" - 24"
48046X	XXLarge	25" - 26"
480499	Reflect. 'RESCUE' Crescent	
480498	Reflect. 'WATER RESCUE' Crescent	



### HAVOC WATER RESCUE HELMET

*Universal Fit*

The Havoc Helmet is your one-size-fits-most solution to whitewater safety. The ratchet-adjust DialFit system lets you custom fit the Havoc with the simple twist of a knob. Plush FIT pads in key contact points provide extra comfort and are fixed, so they won't get lost. Ten ventilation/drainage ports let air in and water out of the lightweight, durable ABS plastic shell. Glued-in EVA foam liner offers excellent impact protection. Meets CE 1385 standards for whitewater safety. Fits a range from 53-62cm (20.86"-24.4") and has an adjustable chin strap.

	Color
208420421	Black
208420422	Yellow
208420424	Red
208420426	Blue
208420429	White



### PACIFIC R7HV WATER RESCUE HELMET

*Sliding Ridge Vent*

Another progressive design from Pacific Helmets. Made using the same materials and processes as the standard rescue helmets, this helmet incorporates a sliding ridge vent to allow water to drain and to provide ventilation in warm climates.

Compliant to ANSI Z89.1.

	Color
481572	Yellow
481574	Red
481579	White



### MAUI DIVE MASK

Low volume, single window design. Black Silicone Skirt. Popular Mask for military and professional divers.

2370503350 Maui Dive Mask



### SEAL SWIM MASK

This is the mask that revolutionized the water industry by adding fit, functionality, and comfort to aquatic eyewear. Patented curved lens provides 180-degree peripheral vision without distortion. Dive quality silicone skirt provides a comfortable watertight fit. 100% UVA and UVB protection.

46010201 Clear Lens

### IMPULSE 3 FLEX SNORKEL

Improved and streamlined. Patented Impulse Dry™ valve stops water from entering the snorkel. Large bore contoured barrel for unrestricted breathing. Self-draining purge valve for use when switching from scuba to snorkel. Pure soft silicone patented Comfo-Bite™ mouthpiece. Includes snorkel keeper.

4601053 Impulse 3 Snorkel



### MILITARY FLEX SNORKEL

Classic neoprene rubber design with flex tube. Used by military units worldwide for its versatility and performance. Ideal for rescue and recover dive teams. Includes keeper for mask strap.

23706930 Military Flex Snorkel

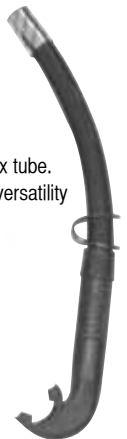





### ACR FIREFLY PLUS

The Firefly Plus uses two standard AA batteries (not included) to power either a convenient working flashlight or a xenon strobe. Completely waterproof, with magnetic switch. Waterproof to 328 ft (100 M). Floats if dropped overboard.

208471714      ACR Firefly Plus



### ACR C-STROBE

The C-Strobe is a waterproof, corrosion-resistant PFD light that delivers more than eight hours of intense one-second interval flashes on two AA batteries (not included). The C-Strobe comes with a wrist loop and meets USCG regulations. 6"H x 1.6"Dia. 2-mile visibility.

238019152      ACR C-Strobe



### SL3 ELED DIVE LIGHT

The SL3 eLED is UK's latest high performance LED dive light designed with a divers tight budget in mind. The exclusive CPO optics guarantees a tight beam with minimum spill light and the Thermal Recovery System recycles wasted heat from the LED back into the battery for increased brightness and burn time. A non-corroding resin case, double o-ring seals, 500 foot depth rating and a rear stainless steel attachment loop as well as 98 lumens output and 30 hours run time all make the SL3 worthy of clear water diving or as an essential technical diving back-up light.

Twist ON/OFF bezel sealed with two O-Rings. Beam produces a bright spot with almost no peripheral light, reducing backscatter. Stainless steel pressure relief valve releases excess pressure due to battery malfunction or flooding. Stainless steel loop clips to BC accessory snap clips. Made in USA.

**Weight:** 11.8 oz.    **Dimensions:** 7.5" x 1.9"

20892202      SL3 eLED Dive Light



### CYALUME LIGHT STICK

6" Lightstick give rescuers a great lighting tool. Shelf Life: 5 years. Glow time 8 or 12 hours. Individually wrapped.

22426125	12 hour Green
22426124	12 hour White
22426120	12 hour Orange
22426122	12 hour Yellow
24426089	8 hour White



### ECOFLARE

Interchangeable halogen bulb and red Ultrabright LED make the EcoFlare a flashing beacon or area an area light. Compact and waterproof. A vital part of any outdoor enthusiast's equipment bag, the Eco Flare can be set on constant, high-output, incandescent mode for use as an area/personal locator light, or on flashing, red Ultrabright LED mode for low-visibility, dark nights. The Ultrabright LED will burn in excess of 500+ hours on 2 AAA alkaline batteries. The Eco Flare can also be attached to your dogs collar for easy identification in low light conditions.

**Power:** 1 watt / 6 Lumens

**Lamp:** High output bulb, 1 Ultrabright red LED

**Batteries:** 2 AAA Alkaline    **Burn Time:** 500 hrs.

**Weight:** 42g

488305      EcoFlare



### RESCUE WETSHOE

Simple, sturdy, dependable. 5mm comfort insole and 2mm plastic midsole. Zippered entry. Manufactured from 3mm neoprene. Sole is wrapped with heavy duty traction pad. Toe and heel cup offer extra protection.

**Sizes:** 4 - 15 (whole sizes only, 1/2 sizes order next larger size)

**Weight:** 36 oz. (pair) **Color:** Black

20842310-XX

Rescue Wetshoe



### ATB DIVE / RESCUE BOOT

All Terrain Bootie combines the comfort of a sneaker with the warmth of a wetshoe. Full molded, arched sole is reinforced with a 2mm plastic midsole shim to increase stability and comfort. 7mm neoprene cushion insoles and 5mm uppers with glued and blind-stitched seams. Heel and toe caps protect from abrasion. Zippered opening.

**Sizes:** 6 - 13 (whole sizes only, 1/2 sizes order next larger size)

**Weight:** 47.2 oz. (pair) **Color:** Black/Gray

20842335-XX

ATB Dive / Rescue Boot



### SWIFTWATER WORKBOOT

Used by river professionals, rescue agencies and Navy SEALs, the Swiftwater Workboot / Wetshoe is the hardest-working river boot on the market today. Lace-up synthetic leather and 5-mm neoprene upper provides warmth, unmatched ankle support and a secure fit. 7-mm neoprene insole absorbs the shock of every step. Heavy-duty lugged traction sole keeps you on your feet in varied terrain. Wear areas are reinforced with synthetic leather and rubber. When you need a water shoe that works as hard as you do, on and off the water, the Swiftwater Workboot is your best choice.

**Sizes:** 6-15 (whole sizes only, Women order one size smaller, 1/2 sizes order next size larger.)

20842338-XX

Swiftwater Workboot



### ROCKET FIN

*Quick-Release Strap*

One of the first vented rubber fins available. Traditional all rubber design. Popular with military and professional divers.

**Dimensions:** 18.5 x 8.5" **Weight:** 6.15 lbs / pair

2370621110

Rocket Fin



### SHREDDER RESCUE FINS

*Fits over Swiftwater Rescue Boots*

Ultra-Light technopolymer optimizes power with up to 50% less weight and bulk. Blade design improves thrust and reduces ankle and leg fatigue. Adjustable buckle with quick-release system secures fins even in swiftwater. Designed to fit all large dive / rescue style boots.

**Dimensions:** 17" x 9.5" **Weight:** 4.3 lbs / pair

46005341

Color

Black

46005342

Yellow/Black

46005349

Replacement Strap



### UNIVERSAL RESCUE FINS

Designed to meet the demands of swiftwater rescue professionals, the Universal Swim Fins also work well for riverboarding and general river snorkeling. These rigid fins are symmetrical so they fit either foot. The wide heel strap is adjustable with a quick tug of the strap end, then you can unclip the strap and your adjustment stays put. The toe piece has a removable rigid insert that lets you select the stiffness you desire. The fins will fit over your river boots - just step in, click in the heel strap and you're ready to go!

**Dimensions:** 19.75 x 8.5" **Weight:** 3.3 lbs. / pair

20841897

Universal Rescue Fins



### SWIFTWATER RESCUE CURTAIN

The Swiftwater Rescue Curtain provides a versatile tension diagonal grab method to use in moving water. The Curtain rests on top of the water and provides a large grab area for confused swimmers and troubled victims. The 10 ft. wide by 4 ft. tall area enables rescuers to position the Rescue Curtain within the width of a channel to catch a victim who is unable to help himself. When used with a tension diagonal, the Curtain works with the current to hold the swimmer as he or she is pulled to shore. This method reduces the amount of strength the swimmer needs to use to hold onto a device while being pulled out of the current to safety. Attaches to rescue rope with carabiners (not included).

#### Moving water situations for the Swiftwater Rescue Curtain:

- Tension Diagonals • Pulling victims onto a boat • Hang from a bridge (downstream)
- Float in a low head dam and pull to shore

2414211 Rescue Curtain



### AIRTRACK INFLATABLE RESCUE PATH

The Airtrack is an inflatable rescue walkway for rescues on water, mud, ice and unstable terrain. Constructed in a catamaran type shape, the Airtrack rescue path has two pontoons running lengthways down the underside of the path. This shape provides exceptional stability on water, especially during casualty recovery, and provides extra ground clearance on ice, mud flats and unstable terrain. The unique footprint also prevents suction on to mud and soft surfaces. Several inflatable paths can be connected using the rapid extension link-up feature. Airtracks can either be connected lengthways to extend the path, or sideways to create a rescue raft. The Airtrack inflatable rescue path is compact and portable, packing away neatly into a carrying bag. It can be quickly inflated and deployed allowing water rescue personnel to have access to the casualty within minutes.

- Non-slip top surface • Strong and durable • Stable • Versatile
- Low maintenance

		Weight
2458231002	2 Meter, Standard	26.5 lbs.
2458231005	5 Meter, Standard	59.4 lbs.
2458231010	10 Meter, Standard	121 lbs.



### FIBRE-LITE RESCUE CRADLE

*For Overboard Recovery, Boarding Ladder and Emergency Stretcher*

The Fibrelight Cradle is an innovative new system designed for the recovery of casualties in the water. The Cradle is secured to the craft at the inboard end, with floats attached to the outboard end. The casualty is guided onto the cradle and the outboard end is then hauled in, bringing them safely on board in the medically preferred horizontal position. Manufactured from a grid of polyurethane coated polyester webbing reinforced with carbon fibre rods, the Fibrelight Recovery Cradle is exceptionally durable.

Dimensions: 52"W x 120"L

2458231501	2 Meter
2458231503	3 Meter

### 13' SELF-BAILING DELUXE RAFT SET

A deluxe set of Raft Equipment that includes what an existing water rescue team needs for boat operations. Large, wide raft for excellent stability. Self-Bailing Function keeps water from filling up and capsizing the raft. Raft constructed of High grade PVC coated fabric.

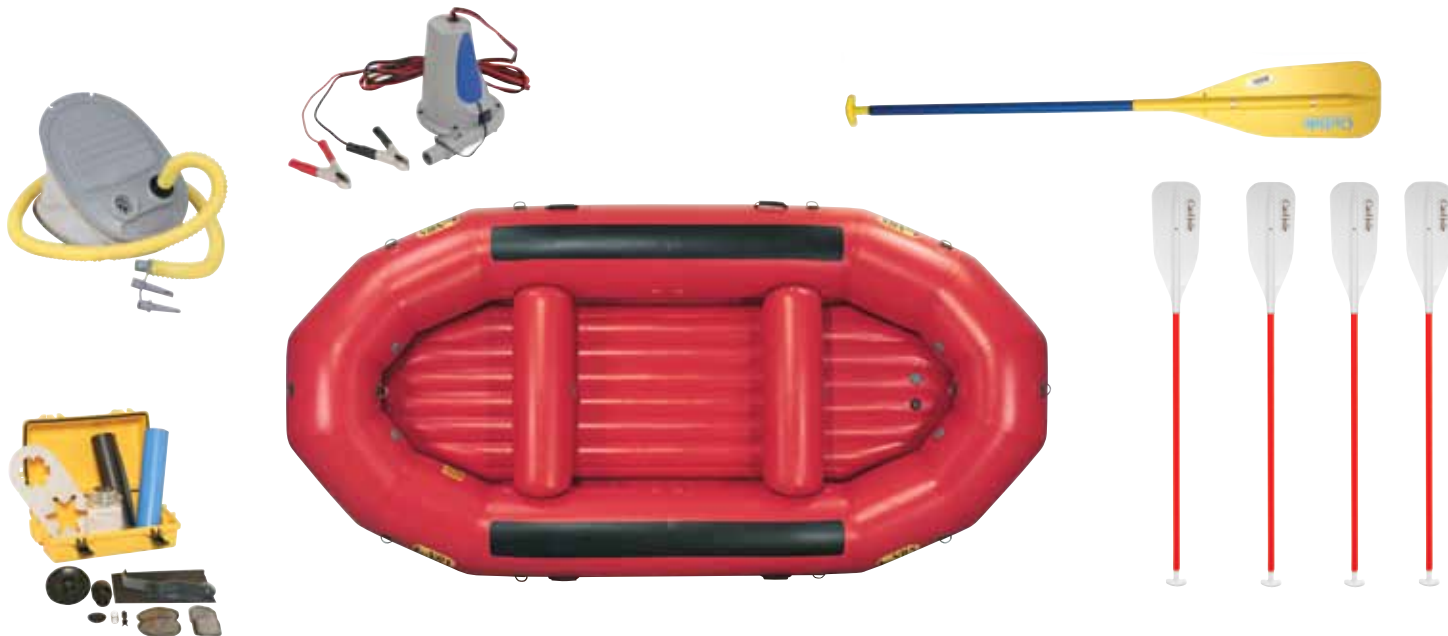

29981012

13' Self-Bailing Deluxe Raft Set





## INFLATABLE RESCUE SLEDS

The RS Series Rescue Sled is great tool for crisis rescues. Fully inflatable, it is lightweight and portable, both inflated and deflated. It is easy to be paddled, pulled by hand, or towed by a jet ski, boat or small hovercraft. The flat bottom makes it exceptionally stable and suitable for use in very shallow water (from only 2"), making it perfect for help in flood rescue. The open, low stern assists with diver deployment and casualty recovery. 10 and 15 man sizes also available. The 3 and 5 man sleds include a removable bolster and are ideal for swift water rescue. The 10 and 15 man sleds have a large floor space and capacity, making them the perfect choice for emergency evacuation and flood rescue situations. To increase capacity, sleds can be linked together.

• **Exceptionally tough and durable** • **Rapid inflation and deployment** • **Easily launched into the surf zone for sea rescue** • **Open stern for easy access and self-bailing** • **Minimal training, servicing and maintenance costs**

\*Exceeds working floor length of competing open end raft.

		Length
2458230103	RS3 Rescue Sled	116"
2458230105	RS5 Rescue Sled	146.5"
2458230110	RS10 Rescue Sled	200"



## MOTOR-READY RESCUE SLED

The Motorized Rescue Sled is a powered rescue craft for use in emergency crisis rescues, i.e. flood rescue, that occur in lakes, inland waterways, flooded urban and coastal areas, and rivers. Combining the versatility and functionality of an inflatable rescue sled with the ease and speed of rescue from a powered rescue boat, the Motorized Rescue Sled offers the perfect solution for water rescue requirements. The Motorized Rescue Sled has a flat bottom and shallow draft, making it suitable for use in shallow waters from approximately 16 in. deep. Weighing only around half that of an equivalent boat, the Motorized Rescue Sled is easy to transport, highly maneuverable, and only requires a small outboard motor. The Motorized Rescue Sled is available in two standard sizes; 10 and 15 man. For mass emergency evacuation or flood rescue sleds can be linked together, or a second sled can be towed behind the Motorized Rescue Sled whilst still maintaining good performance and speed. To assist with boarding, the Motorized Rescue Sled has integral steps at the stern. The flat floor of the rescue craft offers a comfortable and stable rescue platform for passengers, and the inflatable sides give them a reassuring support to lean on.

**Maximum Horsepower:** 15 hp

• **Exceptionally tough and durable** • **Weighs around half that of an equivalent boat** • **Rapid inflation and deployment** • **Compact storage** • **Raised bow for better performance in waves** • **Integral transom with non-return drain port and towing 'U' bolts**

Motor not included.

		Length
2458230210	RS10T Motor-Ready Rescue Sled	160"
2458230215	RS15T Motor-Ready Rescue Sled	200"



## OCEANID RDC SWIFTWATER RESCUE BOAT

The RDC (Rapid Deployment Craft) is the safest, most durable, easy-to-use inflatable rescue boat ever made. It works in so many applications that this may be the only rescue boat your organization needs. Designed to take the stress of work in demanding, water-related rescue situations.

**Length:** 15' 4" **Width:** 48" **Weight:** 50 lbs.

**Tube Diameter:** 12" **Floor Length:** 8' **Access Holes:** 22" x 40"

**Buoyancy:** >2,000+ lbs. **Fabric:** PU/PVC

208486114 Oceanid Rescue Boat



## SUPER CLIP - PADDLE

*Extends Reach*

Superclip Paddle is designed to slip over a paddle blade and hold a carabiner. Now the paddle can be used to extend your reach to a pinned boat or person needing aid. Carabiner and sling not included.

2462003 Super Clip, Paddle



## RAFT PADDLE

The industry standard! This 1-1/8" aluminum shaft extends well into the blade for added strength and is covered with polyethylene to provide a warm, secure grip. The 8" x 20" molded blade uses super-strong polypropylene for a powerful yet lightweight paddle.

208415054 60" Paddle



### RING BUOY

*USCG Approved*

Unicell soft foam. Won't rot or water log. Diameter: 24". Complete with grab lines.

**Weight:** 44 oz. **Color:** Orange



### RESCUE TUBE

Yellow vinyl coating for great visibility and lightweight foam body for handling comfort. 3" x 40" with soft, nylon rope and one-piece foam belt. USCG approved bronze snap hook.

**Weight:** 32.8 oz.



### RESCUE CAN

Features hand grips that are secure and comfortable to grasp and help to calm a panicky swimmer. High visibility Bright Day-glow Orange color.

**Dimensions:** 27.5 x 8.5 x 6" **Weight:** 54.4 oz.

460008	Ring Buoy, 24"
460008-060	Ring Buoy w/ 60 ft. Tether
460008-100	Ring Buoy w/ 100 ft. Tether
460008M	Ring Holder

460001	Rescue Tube, 40"
--------	------------------

460005	Rescue Can
460006	Rescue Can, Max Flotation
460005R	Rescue Can Rack
460006R	Rescue Can Rack, Max Float



### LIFESLED™

*PWC Towable Rescue Board*

Designed for Ocean, Swiftwater and Ice Rescue where a towed board is essential. Severe-duty 3-point non-invasive hookup system with replaceable components. Over 450 lbs. of deadweight buoyancy. Ten fiber reinforced, tacky-when-wet handles are anchored internally. Stows "folded-over" PWC when not in use.

**Dimensions:** 62" x 36" x 4.52" **Weight:** 38 lbs.

351511	LifeSled
351503	Rescue Sled Storage Bag



### INFLATABLE RESCUE BOARD

The NRS Inflatable Rescue Board meets the tough demands of the swiftwater rescuer. Lightweight, stowable, versatile - it's built to last.

• *Inflatable design is easy to stow and transport in the field* • *Top is rugged 840 denier urethane coated nylon* • *Reinforced PVC bottom is slick and durable* • *Two inflatable skegs add directional stability* • *Two sets of heavy duty handles* • *Reinforced 3" D-ring on the nose for towing*

**Dimensions:** 58" x 30"

20841868	Inflatable Rescue Board
----------	-------------------------



### CARLSON RESCUE BOARD

*Lightweight & Maneuverable*

For recreation or rescue. Solid Ethafoam with a slick bottom for performance and durability. (3-year warranty against delamination) Oversize Shipping Charges Apply.

**Color:** Black

20841870	Carlson Rescue Board
----------	----------------------

# RESCUETECH THROW BAGS

## Complete with Throwline and Ready to Use

Our Water Rescue Throwbags have been completely redesigned to give more features and make them easier to use. All bags utilize our Progressive Sewing Technology to give greater strength and resistance to abrasion. All ropes float - even when wet.

### All of our bags feature:

- Double Stitched Seams • Reinforced Bottom Seams • Quick-Adjust Bucket Handle • Drawstring with Durable Cord-Lock • Drainage Grommets



## STANDARD WATER RESCUE THROW BAG

Standard bags are manufactured with a urethane-coated 400 Denier water-resistant nylon for superior abrasion resistance.

		Length	Strength	Rating	Weight
598301050	3/8" Pro-Poly	50'	2,960 lbf.	Throwline	1.8 lbs.
598301075	3/8" Pro-Poly	75'	2,960 lbf.	Throwline	2.7 lbs.
598301100	3/8" Pro-Poly	100'	2,960 lbf.	Throwline	3.4 lbs.
598302035	3/8" Standard Poly	35'	1,900 lbf.		1.25 lbs.
598302050	3/8" Standard Poly	50'	1,900 lbf.		1.25 lbs.
598302075	3/8" Standard Poly	75'	1,900 lbf.		2.0 lbs.
598302100	3/8" Standard Poly	100'	1,900 lbf.		2.3 lbs.
598303050	8mm NFPA	50'	4,300 lbf.	Throwline	1.2 lbs.
598303075	8mm NFPA	75'	4,300 lbf.	Throwline	1.7 lbs.
598303100	8mm NFPA	100'	4,300 lbf.	Throwline	2.3 lbs.

## DELUXE WATER RESCUE THROW BAG

The Technical bags give the rescuer a top of the line throwbag. Manufactured of 1000 denier Cordura in the bottom end and 400 denier in the sides and open end. The "Tech" bag also features Reflexite retro-reflective trim and elastic lightstick holders.

*(Lightstick not included.)*

		Length	Strength	Rating	Weight
598311050	3/8" Pro-Poly	50'	3,500 lbf.	Throwline	1.95 lbs.
598311075	3/8" Pro-Poly	75'	3,500 lbf.	Throwline	2.4 lbs.
598312035	3/8" Standard Pro-Poly	35'	1,900 lbf.		1.45 lbs.
598312050	3/8" Standard Pro-Poly	50'	1,900 lbf.		1.25 lbs.
598312075	3/8" Standard Pro-Poly	75'	1,900 lbf.		2.0 lbs.
598313050	8mm NFPA	50'	4,300 lbf.	Throwline	1.41 lbs.
598313075	8mm NFPA	75'	4,300 lbf.	Throwline	1.81 lbs.



## RESCUE STICK

### Throwable Emergency Rescue Inflatable

The Rescue Stick™ provides rapid flotation assistance to a person at risk of drowning. Simply remove the baton shaped Rescue Stick™ from its waterproof bag and throw near the person. Once contact is made with the water it inflates in seconds to a large horseshoe shape. Measuring only 14" in length and weighing 15.5 oz., the Rescue Stick™ is the most versatile rescue flotation device available. Easily stowed in a boat, vehicle, backpack or by the pool. The Rescue Stick™ is an invaluable tool for first responders to provide emergency flotation when no water rescue gear is available.

**Weight:** 25.6 oz.

2049101	Rescue Stick
2049103	Rescue Stick, Training Model
2049105	Rescue Stick Rearm Kit



## LSP CINCH COLLAR

Easy to use - The victim simply enters the harness with head and arms extended before tension is applied by the rescuer. The victim's weight will release the connector and allow the collar to cinch around him, preventing him from slipping out in the event he becomes unconscious. Durable-The interior of the Cinch is a non-absorbent, closed-cell foam. The outer covering consists of a tough, stain-resistant, washable Cordura which provides protection and comfort to the victim.

21542010 LSP Cinch





### PUBLIC SAFETY DIVER QUICK-RELEASE SNAP

A low profile Marine-Grade, Quick-Release snap to be used between Diver's Chest harness and Tender Line. Webbing release strap. Designed to be tied or girth hitched to tender line.

460135 PSD Quick Release Snap



### DIVE RESCUE SEARCH LINE

Special 6mm Search Rope reduces resistance and drag as diver works search pattern. Kernmantle design virtually eliminates kinking found in monofilament "tow-line" braid. High quality bag carries 200 ft. of search line.

6mm Rope Strength: 600 lbf.

8mm NFPA Throwline Rope Strength: 3,699 lbf.

		Weight	Length
460022	6mm Search Line	48 oz.	200'
460122	8mm Search Line	68 oz.	200'



### PUBLIC SAFETY DIVER CHEST HARNESS

A must for all PSD dive operations. Made with 2" Chest Webbing, 1" Shoulder webbing, and steel D rings. Shown with Diver's Quick-release connector and rope (not included). NOT for high Angle Rescue.

460133 PSD Chest Harness



### PRO GUARDIAN WAIST THROWBAG

#### Strong Dyneema Rope

Features an internal throw rope in a bag that pulls completely free from the waist belt. Includes 55 feet of extra-strong 1/4" Dyneema® rope. Clips securely around your waist with an adjustable belt and a quick release buckle. Webbing loops along the belt are provided for carabiners. Maximum load indicated is for the rope alone.

Rope Length: 55' Rope Size: 1/4" Dyneema®

Rope Strength: 2,608 lbs. (max)

208418282 Pro Guardian Throwbag



### GUARDIAN WAIST THROWBAG

#### Lightweight Polypropylene Rope

The Guardian Bag is worn on your waist, so whether you're in your boat or walking the banks, the throw bag is always at your fingertips. Features an internal throw rope in a bag that pulls completely free from the waist belt. Contains 55 feet of 1/4" polypropylene rope. Clips securely around your waist with an adjustable belt with quick release buckle. Webbing loops along the belt are provided for carabiners. Maximum load indicated is for the rope alone.

Rope Length: 55' Rope Size: 1/4"

Polypropylene Rope Strength: 950 lbs. (max)

208418281 Guardian Throwbag



### PELICAN FLOAT

#### Marker Recovery System

Reusable Buoy made of structural foamed resin. Includes over 100 ft. polyethylene 225 lbs. test line. Includes 6 oz. non-drag dispatchable anchor.

Color: High-visibility yellow with day-glow rings Weight: 16 oz.

460020 Pelican Float



## WARNING

Technical rescue and safety is potentially hazardous. Any person using equipment sold by RESCUE TECHNOLOGY in any manner is personally responsible for learning the proper techniques involved, and assumes all risks and accepts full and complete responsibility for any and all damages or injury of any kind, including death, which may result from the use of any RESCUE TECHNOLOGY equipment.



### RIVER RESCUE SHORT KNIFE

Features quality 420 Stainless Steel 3" blade with serrated top edge for rope cutting, blunt chisel tip and line cutter. Molded Grip and sheath. Blade Shank protrudes past handle end to allow use as striking tool.

**Dimensions:** 6.75" x 1.25" **Weight:** 4 oz.

	Color
6301201	Black
6301202	Yellow



### BLUE TANG DIVE KNIFE

The Blue Tang is a full size, rugged, multifunctional knife designed to meet the basic needs of every diver. Features Power Grip, hooked edge line cutter, 5 inch hollow ground double edge blade. Blunt tip and Steel end cap makes the Blue Tang the perfect work tool for Dive/Rescue.

**Dimensions:** 10 x 2.2" **Weight:** 9 oz.

**Color:** Black/Yellow

630125	Blunt Tip
630126	Drop Point



### DIVE RESCUE SHEARS

*Great for Rescue Diver Safety*

EMT Shears in a Pouch that secures to BC Shoulder Strap or autoflator hose. Includes Stainless Steel 7.5" EMT shears and adjustable pouch.

630111	Dive Rescue Shears
--------	--------------------



### SQUEEZE LOCK KNIFE

A classic dive knife. Blade made from 304 stainless steel or high grade Beta Alloy Titanium. Patented Locking mechanism securely locks knife in sheath, but releases easily with a squeeze of the handle. Included mounting components allow the knife to be mounted to grommets, hose straps, or belt. Sheath has molded strap slots for use hose mounting straps.

**Length:** 6.5" Overall; 3" Blade.

A. 23704752	Stainless Steel Blunt Tip
B. 23704852	Titanium Tanto Tip



### PILOT KNIFE

Rescue professionals will really love the features of the Pilot Knife. Features both smooth and serrated sections plus a rope cutting hook. The blunt tip design protects against unintentional punctures! The unique sheath firmly locks the knife in place and only lets it go when you squeeze both sides of the release. Contoured handle and rubberized grip. Clip on sheath attaches firmly to PFD lash tab. Built in glass breaking tip on the end of handle.

**Length:** 7.5" Overall; 3" Blade.

	Color
208427550	Orange
208427551	Black

### FUSILIER RESCUE / DIVE KNIFE

This full feature knife is the perfect knife for rescuer/divers who do not want to carry a big knife. It is small, lightweight and designed to fit every diving style. Features: Power Grip, Serrated Edge, Hooked Edge 4 inch double edge hollow ground blade, One Hand insertion and removal. **Dimensions:** 8.75" x 2"

**Weight:** 6 oz.

**Color:** Black/Yellow

630122	Fusilier Rescue / Dive Knife
--------	------------------------------



## WATER RESCUE JAWS

With Water Rescue Jaws, you can:

- Probe in deep water with the 18 foot telescoping pole.
- Search effectively in open water.
- Search effectively in muddy water.
- Search through ice.
- Search through slow currents.
- Retrieve a victim without the threat of puncturing skin.
- Store easily in a 24" by 72" area.

2414103

Water Rescue Jaws



Snag-Plate stays in bag bottom until needed.

## WILD WATER SNAG PLATE

Add Line Retrieval to your Throwbag

Allows the user to snag and pull in a rope with a standard throwbag. Once installed in the bag, it will always be ready when needed. Snag Plate™ is made of a strong composite material. Install the Snag Plate in your throw bag by threading it on the rope and stowing it in the bottom of the bag before loading the loose rope in the bag. To use the Snag Plate, simply empty the bag of rope, expose the plate, add weight to the bag using rocks or other available objects and proceed with your rescue. Toss it out over the rope you want to retrieve and haul it in. There is no longer a need to carry costly additional equipment, and the Snag Plate can be added to any standard throwbag. Once installed in the bottom of the throwbag, it does not interfere with normal throwbag use.

20841819

Snag Plate

# COLD WEATHER

Cold weather is tough on all rescuers. But, it is especially tough on those who encounter ice. We have included top quality equipment that gives rescuers an advantage when dealing with ice.



## ICE RESCUE SLED

Thin ice is a trap and every year hundreds of people fall into that trap. The RESCUE ALIVE Sled enables your rescuer to run over very thin ice by distributing his weight over a large surface or to paddle through open water to reach a victim quickly. The unit weighs 88 pounds and provides 600 pounds of flotation. The unit is deployed by releasing one Velcro™ strap, which is then used to tether the modified paddle. Pontoons are made from expanded polystyrene core with high density polyethylene covering.

Dimensions: 23" W x 89" L x 6.25" D

2414201

Ice Rescue Sled

## ICE ANCHOR

Super Corrosion Resistant

Plated CrMo tubes with high strength hangers are the ideal anchor tool for Ice Rescue. Rigging point works like a wrench when screwing the Anchor in or out of the ice.

Length: 7.75" (19 cm) Weight: 7.2 oz.

46001919

Ice Anchor



## STABILICERS

Stabilicers™ provide the traction you need to walk, lift, carry or even run on glare ice, reducing injuries in severe winter rescue conditions. Designed with Velcro® fasteners to allow easy attachment over almost any boot or sole. 34 case-hardened, replaceable steel cleats in Vibram® soles bite into ice and snow increasing safety and maneuverability.

Weight: 24 oz. (Med)

	Size/Item Description	Men's Size
208422453	M	8 - 10
208422454	L	10.5 - 12
208422455	XL	12.5 - 14
208422458	Replacement Cleats, 50 ea.	



## PICK OF LIFE ICE AWLS

Pick-of-Life awls are for self-rescue, allowing you to crawl on top of the ice using the picks as traction. You can also slide them to someone who has fallen through the ice.

208422459

Pick of Life



# WATER RESCUE

## ACCESORIES & DRYSUIT CARE

Accessories for Water Rescue Personnel. Hangers, Bags, Training Aids and more at RescueTECH.com in our Water Rescue Accessory Section.



### WONDER PUMP 6

The Bravo Pump is a great top off pump. This compact pump allows you to connect to even the hard-to-reach valves on any raft. 5' non-kink hose and 7 adaptors are included with the pump. The double action pump, working to inflate on both the upward and downward motions of the handle, speeds inflation. Stroke volume of about 1.6 Gal/6 L.

**Dimensions:** 4" x 18.5"

20841701 Wonder Pump 6



### BRAVO 2 FOOT PUMP

Inflate small rafts and IK's without back strain. By switching attachment point, the pump works as either an inflator or deflator. Heavy-duty bellows are sandwiched between durable footplates. A convenient 4.5' hose gives you the length you need to reach more than one valve without moving. Includes 9 valve adapters.

20841703 Bravo 2 Air Pump



### BLAST PUMP

12 vDC

Why pump by hand if you don't have to? Let the Blast Inflator Pump do the work for you. Its compact size and rugged durability will last for years. This 12-volt pump is capable of inflating to 1.5 psi for a fast and easy inflation. It also deflates making it quick and easy to get your inflatable packed back up. Comes with an adapter to fit a wide variety of valve types. Inlaid rubber insulates from heat and sound while providing a more secure grip. 12 foot power cord allows you to easily inflate your boat near your vehicle. Alligator clamps allow quick and easy connection to your vehicle's battery. Pump designed to run for up to 20 minutes without overheating.

20841726 Blast Pump



### RAFT REPAIR KIT

Hypalon raft and inflatable kayak repair kit. Contains the essentials for emergency boat material and Leafield valve repair. Repair parts are fitted in a Witz Utility Locker I Dry Box, with gasket-lined, watertight lid. This kit is intended to give you the basics to make an emergency on-the-water repair. Other items, such as Toluene and Clifton Hypalon Accelerator (sold separately), are recommended for more complete, long lasting repair jobs.

See the parts list for the included items.

• 4 oz Adhesive • One 6"x18" Piece of Tube Material • One 6"x18" Piece of Floor Material • Roller Rasp • Round & Oval Rubber Temporary Patches • Sand Paper • Hypalon glue instructions included • Leafield Valve Wrench • Leafield Adapter • Plug for Leafield PR Valve • C7 Repair Kit: Pin, Spring, Rubber Stopper

208419844 Hypalon (Red)  
208419846 Hypalon (Blue)  
208419769 PVC (Gray)



### RAFT CLEANER

High-quality cleaner formulated specifically for PVC and Hypalon® inflatables. Removes dirt, oil, stains and frame marks. Rinse surface before applying, and apply 303® Protectant after cleaning. Biodegradable.

2084191864 Gallon



### RAFT PROTECTANT

The most powerful UV screening protection ever made. Use it on everything from boats to apparel. 303 Aerospace Protectant is - "SPF 40 For Your Stuff!" Helpful in prolonging the lifetime of your raft. Don't forget to use this on your paddling apparel that have latex gaskets. For use on vinyl, clear vinyl, inflatable boats, fiberglass, rubber & all UV sensitive plastics. Easy to use - just spray on and wipe dry! Environmentally safe product that is non-toxic and biodegradable.

2084190916 16 oz. Spray  
2084190932 32 oz. Spray  
2084190964 Gallon Bottle



### DIVE MASK TRAINING BLACKOUT COVER

Finally, a reusable Diving Mask Cover that works. Made from tough, coated nylon fabric and elastic drawstring adjuster. Can be easily removed in an emergency situation. Excellent access to nose cup for clearing ears.

460101	Standard Mask Blackout Cover
460111	Full Face Mask Blackout Cover



### TRAINING AIDS

Rescue Diver training aid requirement. Solid rubber. For pool skills training for divers. 5" Donut rings may be used for assorted training exercises.

4600161	Block, 10 lb. (each)
4600162	Donut, 5" (each)



### ZIPPER LUBRICANT

Lubricates and prolongs the life of zippers on wetsuits, drysuits and booties.

20842288	Zip Tech
----------	----------

### SEA GOLD ANTI FOG GEL

Rated BEST Anti-Fog by Rodale's SCUBA DIVING Magazine! The clear choice in anti-fog gels. Our unique clear formula means long lasting anti-fog protection. Sea Gold is highly concentrated and designed for quick, simple, in-field application. Sea Gold is safe for all glass and plastic lenses and will not harm surrounding silicone or rubber support frames. Not recommended for swim goggles.



238140851	Sea Gold, 1.25 fl. oz.
-----------	------------------------

### DRYSUIT SEAL SAVER

It's not fun to replace gaskets, it's even worse to have one tear in the middle of a rescue. Seal Saver will condition and protect your gaskets, possibly saving the day! 100% silicone formula is durable and stays supple in cold or heat. Regular application of Seal Saver preserves and maintains latex and neoprene seals while inhibiting oxidation and deterioration. Seal Saver provides a protective, high gloss finish. Apply thin coat to inside and outside of a dry seal with cloth or other applicator. Wipe off excess and buff with clean cloth. Avoid contact with adjoining dry suit fabric. 1.25 oz.



2084229512	Seal Saver
------------	------------

### ZIPPER CARE

Zip Care is the ultimate zipper care for plastic, nylon or metal zippers. Unique push-pull brush top enables the cleaner to be delivered between the teeth and physically removes harmful dirt, sand, and salt deposits that can jam the zipper. Cleans drysuits and wetsuit zippers. Mild lubricant without silicone.



20842290	Zipper Care
----------	-------------

### WETSUIT SHAMPOO

Complete, scientifically balanced maintenance system for all neoprene and water sports gear. Ideal for wetsuits, drysuits, boots and gloves, fishing waders, orthopedic supports, lycra body suits and more. Leaves neoprene articles free of organic residue, chlorine and salt deposits. Chlorine-removing agents and conditioners help prevent premature aging and oxidation.



20842249	Gallon
20842248	8 oz.

### 303 HIGH TECH FABRIC GUARD

*Protects Drysuits and PFD's*  
Powerful enough to protect fabrics in the harshest environment... outdoors. 303 High Tech Fabric Guard™ helps keep your gear looking and performing like new. Restore lost water repellency and stain repellency without affecting the breathability of the fabric. Use after cleaning fabrics to revive water repellency and stop leaks. Helps to repel dirt, grease, water, oil-based stains and UV rays. Non-toxic and odorless formula is easy - spray on, let dry.  
**Weight:** 16 oz.



2084190816	303 Fabric Guard
------------	------------------

### AQUASEAL WETSUIT REPAIR ADHESIVE

The industry standard for maximum strength repairs to wetsuits, dry suits and all water sports products. Flexible urethane formula waterproofs, seals and protects against abrasion. Hundreds of water sports and household uses. Flexible Urethane formula that waterproofs, seals and protects against abrasion.  
*Flammable - UPS ground only.*



2282572	Aquaseal, 1 oz. Tube
---------	----------------------



### SUPER HANGER

Useful and economical for hanging a variety of dive equipment.

**Dimensions:** 9" x 16.6" x 1.2" **Weight:** 9.6 oz.

460012 Super Hanger



### SUPER B.C. HANGER

Keeps Expensive equipment off the floor for proper drying and storage. Supports up to 20 lbs.

**Dimensions:** 10" x 16" x 1.2"

**Weight:** 8.8 oz.

460010 Super B.C. Hanger



### SUPER ACCESSORY HANGER

Ideal for drying and storing gloves, booties and hood.

**Dimensions:** 13" x 20" x 1.2"

**Weight:** 14.4 oz.

460011 Super Accessory Hanger



### DRYSUIT / EXPOSURE SUIT HANGER

Wide 4.5" hanger "arms" for ultimate protection of expensive Drysuits and Exposure suits.

**Dimensions:** 15" x 16" x 4.5"

460013 Drysuit Hanger



Lanyard Not Included

### FOX WHISTLE

One of the loudest whistles available. "Pea-less" design functions when wet - even under water.

**Color:** Orange, Yellow

2282464X Fox Mini Whistle

2282465X Fox 40 Whistle

2282469X Fox 40 w/ Coil

### WATERPROOF RADIO POUCH

Waterproof to 30 ft.

Total watertight protection, effectively and inexpensively, to hand-held VHF/UHF radios.

Waterproofs your radio in seconds. Will float with radio inside. No loss of signal. Salt-water proof. UV-Stabilized. Operating temperatures: -25°C to +90° C. Complies with SOLAS.



Dimensions

811139 Standard 13" x 3.9" x 6.9"

811149 Large 15.7" x 5" x 7.9"



## WARNING

Technical rescue and safety is potentially hazardous. Any person using equipment sold by RESCUE TECHNOLOGY in any manner is personally responsible for learning the proper techniques involved, and assumes all risks and accepts full and complete responsibility for any and all damages or injury of any kind, including death, which may result from the use of any RESCUE TECHNOLOGY equipment.





# TRAINING

## BOOKS & VIDEOS

We have collected the finest selection of books for Technical Rescuers. All of the books we offer are the most current edition and give rescuers extra resources for training and planning. From Water and Ice Rescue to High Angle, Trench and Confined Space. We have them all!



### PUBLIC SAFETY DIVING

By Hendrick and Zaferes

Written for instructors, dive team captains, surface teams, and underwater personnel. Offers information on procedures for safe operations and proper methods of training. Safety is the consistent theme throughout, with an emphasis on surface support, accident prevention,

contingency procedures, and standard operating guidelines. Includes methods of search in Black Water, Swiftwater, and Contaminated Water.

899130 Public Safety Diving



### SWEEP AWAY DVD

Video Guide to Water Rescue Operations

A comprehensive rescue training film that has been specifically developed for emergency personnel who are called upon to respond to water emergencies. Swept Away provides an in-depth look at the essentials of water rescue and can serve as an invaluable training resource for both new and experienced emergency personnel. **Running Time:** 30 Minutes

899520 Swept Away

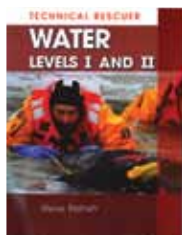

### TECHNICAL RESCUER WATER LEVELS I & II

Finally, a book that covers all 5 of the sub-disciplines of water rescue – in a single resource! TECHNICAL RESCUER: WATER is based on the NFPA 1006 Technical Rescuer Standards, and covers everything from

surface water rescue and ice rescue to swiftwater rescue, surf rescue, and more. Perhaps most importantly, the author recognizes that different agencies have different processes, and incorporates that by discussing all of the various types of equipment and how it can be used. A bonus chapter on watercraft rounds out the book's comprehensive coverage, making this an ideal book for first responders, firefighters, rescue technicians, and anyone seeking in-depth knowledge of water rescue techniques and standards.

899138 Tech Rescue, Water



### SWIFTWATER RESCUE

by Slim Ray

An in-depth look at swiftwater rescue for the professional. Topics include basic rescuer safety considerations, river hydrology, equipment, shore-based, boat-based, and in-water rescue techniques, medical considerations, rigging for river rescue, incident command,

and swiftwater training. Illustrated with line drawings and photographs.

**Paperback 360 pages.**

899122 Swiftwater Rescue



### STAYING ALIVE: SWIFTWATER RESCUE TECHNIQUES - DVD

This video can be used as a training aid or as a great addition to your reference library. It contains the latest in rescue techniques, with many live footage scenes & actual rescues. Perfect for the first responder all the way up to Technical Rescue

Professionals. Includes: rescue basics, gear, hydrology, river features, rescue scene management & incident size up, self rescue, and more. Also knots, anchors, lowhead damn rescue, foot entrapment & PFDs.

899521 Staying Alive, DVD



### SURFACE ICE RESCUE

By Hendrick and Zaferes

This book provides practical, up-to-date information on training, team management, equipment, and techniques for ice rescue teams.

- **Preplanning**
- **Three levels of training**
- **Managing an operation**
- **Ice rescue equipment**
- **Duties and responses**
- **Communication**
- **Special situations**
- **The four processes of heat loss**

**200 pages**  
**Dimensions:** 7"x 10"

899134 Surface Ice Rescue



### SWIFTWATER FIELD GUIDE

Companion to Swiftwater Rescue

Handy 4" x 6" pocket reference to topics like basic rescuer safety, river hydrology, equipment, shore-based, boat-based, and in-water rescue techniques, knots, rigging for river rescue, helicopters, incident command, and special situations.

**52 pages**

899124 Swiftwater Field Guide



### RIVER RESCUE

by Bechdel and Ray

A must read for the weekend warrior or the hard-core pro and provides useful tools and techniques for self rescue and rescue by others. Through all editions, Bechdel and Ray's River Rescue has remained an invaluable resource for anyone who has gone boating. With even

more illustrations and photographs this completely revised new edition will help you prepare for the adventure that lies ahead.

899110 River Rescue



### Z-DRAG CRIB SHEET

Durable plastic "crib sheet" is a handy reference when you need to rig a quick 3:1 mechanical advantage system. They show how to set up a Z-Drage, Vector Pull, C+Z, Double Z. Also includes important knots.

**Dimensions:** 6 x 3.75"

899116 Z-Drage Crib Sheet

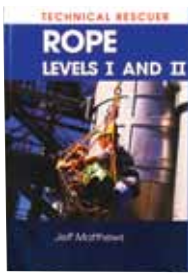

## TECHNICAL RESCUER ROPE - LEVELS I & II

Practical, thorough, and current, this guide to rope rescue offers you detailed instructions for numerous rope rescue techniques, as well as industry insight on how to apply these techniques effectively on scene. Based on the 2008 NFPA

Standard 1006 and 2009 NFPA Standard 1670 Technical Rescue: Rope Rescue provides expansive coverage, including commonly used knots, practical rigging methods, incident and scene management, lowering systems, tensioned rope systems, and more. With a comprehensive yet simplified approach to a wide variety of techniques, the book breaks down some of the barriers that have traditionally divided urban rope rescue teams and rural or wilderness rescue teams.

899135 Tech Rescue, Rope I & II



## TECHNICAL RESCUE FIELD OPERATIONS GUIDE

by Tom Pendley

Contains over 150 high quality graphic illustrations, command checklists, and easy to follow, step-by-step procedures for rope rescue, confined space rescue, swiftwater rescue, trench rescue, structural collapse rescue, and helicopter rescue.

Dimensions: 4" x 6.5"

899120 Technical Rescue Ops Guide



## TECHNICAL RESCUE RIGGERS GUIDE

Contains dozens of illustrations and photographs to use as a quick reference for modern rope rescue techniques. This handy guide displays pulley systems, tandem prusik belays, knots, bends, hitches, litter packaging, and much more. Note: This is not an instructional text, but rather

a quick reference guide for trained personnel.  
Dimensions: 4" x 6"

899123 Technical Riggers Guide



## TECHNICAL RESCUE OPERATIONS VOLUME I

Planning, Training & Command

The new rules of rescue have improved the way firefighters and other first responders are able to detect, locate, treat, and extract trapped victims in practically any situation by emphasizing factors like

innovative training, better equipment, and more intelligent planning by well-informed decision-makers. Technical Rescue Operations, Volume I: Planning, Training, and Command lays the framework for responding to technical rescues and disasters of all types in the safest and most effective manner.

899132 Technical Rescue Ops I



## TECHNICAL RESCUE OPERATIONS VOLUME II

Common Emergencies

The second in a 3-volume series covers responding to, managing, and conducting rescues in the "daily" setting of fire/rescue agencies. This volume explains how to handle more complex and large-scale rescue operations

that challenge responders to apply solid rescue principals for longer periods of time, with the assistance required of additional resources and under more strict command and control because of the scope of the incident, its newsworthiness, crowds of people arriving on the scene, and getting the immediate attention of local or regional elected officials.

899133 Technical Rescue Ops II



## HIGH ANGLE RESCUE TECHNIQUES

3rd Edition

A textbook style publication that is designed to teach rope rescue techniques in a systematic manner. Step-by-step approach, full color text makes it easy to learn. Includes planning for an incident, managing a team,

troubleshooting problems, operating equipment, and much more. Primarily written from a search and rescue point of view. 407 pages. Hundreds of Photos and illustrations. Includes handy Field Guide.

Dimensions: 8.5 x 11"

899107 H.A.R.T w/ Field Guide

899107B H.A.R.T Book Only

899107G H.A.R.T Field Guide

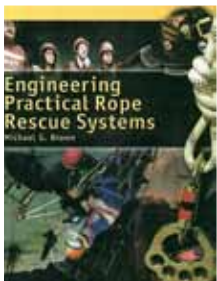

## ENGINEERING PRACTICAL ROPE RESCUE SYSTEMS

by Mike Brown

The NEW Standard by which all technical rope texts will be judged. Thoroughly researched, comprehensive, and easily understood. Covers everything from forming and training a rescue team to traverse engineering.

899104 Engineering Rope Rescue Sys.

899104G Instructor's Guide



## THE MORROW GUIDE TO KNOTS

A MUST book for those interested in tying or teaching knots. Excellent directions for tying nearly all useful knots. Sections on cordage, utility knots, hitches, tackle, and decorative knots. 259 pages, over 600 photographs.

Dimensions: 7.5 x 5".

899105 Morrow Guide To Knots



## ON ROPE - 2ND ED.

Excellent reference for those interested in single rope techniques. Written from a recreational point of view, it is nonetheless comprehensive and very informative. Contains large glossary of rope work terms and describes rappelling, ascending, and other techniques.

Dimensions: 8.5 x 11"

899108 On Rope



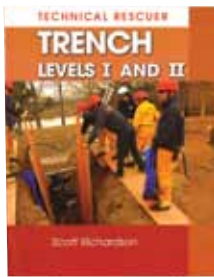

### TECHNICAL RESCUE TRENCH - LEVELS I & II

Technical Rescuer: Trench meets the requirements for Chapter 8 of the 2008 Edition of NFPA Standard 1006 and focuses on the key topics of trench rescue, from exploring the characteristics of trench collapse to the necessary steps for developing an

efficient trench rescue team. Offering comprehensive coverage of key concepts, including illustrating the breakdown of the trench, developing a response plan, implementing rescue operations and the necessary skills for successful leadership and management, this book helps the rescuer both prepare for the incident as well as understand how these skills contribute to a successful response.

899137 Technical Rescue, Trench



### TRENCH RESCUE: AWARENESS, OPERATIONS, TECHNICIAN, 2ND ED.

The most comprehensive textbook ever published on rescue operations in trench emergencies. Author C.V. "Buddy" Martinette covers everything from basic

concepts of risk benefit to practical procedures for technician-level trench protective systems. The Second Edition includes current information on trench tools and equipment, PPE, rescue system preparation, types of collapse, hazard control, and more. The text includes up-to-date coverage of Trench Rescue Sections of NFPA 1670, NFPA 1006, and OSHA CFR § 1926 Subpart P, Excavations. The Second Edition now helps students make more effective use of class time by providing printed PowerPoint slides directly within the text.

899140 Trench Rescue, 2nd ed.  
899141 Operational Field Guide

### TRENCH RESCUE

A must read for those in trench rescue situations, this vital new resource demonstrates a systematic approach to safely and successfully carrying out a trench rescue operation. 258 pages. Over 300 step-by-step photos.

Dimensions: 8.5 x 11"

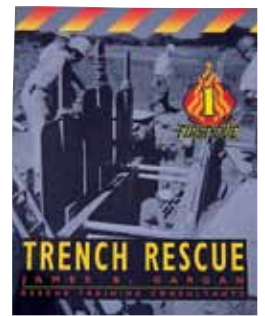

899119 Trench Rescue



### CONFINED SPACE RESCUE

by Chase Sargent  
Bridges the gap between theory and practice. A comprehensive guide to hazardous atmospheres, detection equipment, breathing apparatus, ventilation, retrieval systems, backup teams, and operational procedures. Covers: Forming a Team, Planning, Training, Equipment, Command,

Response, Entry & Rescue, and much more.

244 pages

899112 Confined Space Rescue



### CONFINED SPACE AND STRUCTURAL ROPE RESCUE

The complete guide for technical rescue from man-made confined spaces and industrial environments. Covers all aspects of rescue operations. Topics include team development, rigging and hauling techniques, and hazard reduction and compliance issues.

384 pages, 200 illustrations

Dimensions: 8.5 x 11"

899118 Confined Space & Structural Rope Rescue



### TECHNICAL RESCUER CONFINED SPACE - LEVELS I & II

Meets the intent of Chapter 7 of the NFPA 1006, 2008 ed. This book drives the reader to become proactive in rescue by recognizing the hazards of a confined space, identifying which of those hazards can

be managed and then taking the steps to manage the hazard. It also covers the basic information that provides the foundation for rescue operations. Methods covered include preplanning a rescue, providing built in rescue equipment and managing the hazards of a confined space, as well as a critical discussion about accident prevention.

899136 Tech Rescue, Confined Space



### CONFINED SPACE RESCUE

by Browne / Crist  
A complete text that focuses on confined space operations from hazard recognition to rescue operations. Explains hazards of confined spaces and integrating ICS into the rescue operation. Nine step process with checklists simplifies the toughest rescue operations. Case studies and real life examples.

204 pages

899131 Confined Space Rescue  
899131G Instructor's Guide



### COMMAND BOARD

The Accountability / Command board helps keep track of rescuers and organizes your incident command structure. It features an 18" x 24" dry erase board with the ICS structure screened on it. Includes velcro strip for name tags and twin flashlight harnesses to light the board. Manufactured from padded Ballistic nylon, pockets accommodate two radios or cell telephones and zippered pockets for clipboards, command vests, and writing utensils. The case will stand by itself or hang from a vehicle window or roof gutters to make a handy command station/table.

809801 Command Board

Equipment not included.





# PROTECTIVE WEAR

## FIELD OPERATIONS GEAR

From Helmets to lighting devices, our equipment protects rescuers during field operations. Durability and quality are paramount factors when choosing protective equipment and we have taken care of this for you. Our selection allows rescuers to get the best fit of equipment to the users' requirements.



### R5SL NFPA HELMET

*Certified NFPA 1951*

The R5SL Series of multi-purpose helmets are ideal for rope rescue, technical rescue, or USAR operations. The lightweight Dupont™ Kevlar® reinforced outer shell offers superior strength and durability and is backed by a 6-year warranty. The best warranty in the industry! The R5SL NFPA Helmet's lightweight Dupont™ Kevlar® and composite shell weighs less than competitive fiberglass and composite alternatives. Composite resins offer higher temperature resistance (up to 600°F) without distorting or melting. 3-point polyester chinstrap with quick-release buckle keeps helmet in place and the 6-point ribbon cradle harness offers superior comfort.

Compliant to ANSI Z89.1 and certified to NFPA 1951 Utility Standard.

	Color
4815532	Yellow
4815534	Red
4815536	Blue
4815539	White

### R3-V USAR W/ FLIP DOWN VISOR

*Certified NFPA 1951*

The R3-V USAR helmet is a natural progression of the R3 USAR Helmet. Featuring a Flip-Down visor, the helmet features lightweight Dupont™ Kevlar® and composite shell that weighs less than competitive fiberglass and composite alternatives. High-gloss paint finish available in a variety of colors. Ratchet headband with easy-to-adjust dial ratchet accommodates a variety of head sizes (54-64cm). 3-point Nomex® chinstrap with flip-down visor.

Certified to EN443 and NFPA USAR 1951-2007. Compliant to ANSI Z89.1 (type 2).

	Color
481444	Red
481446	Blue
481449	White

### R3-KIWI™ USAR HELMET

*Certified NFPA 1951*

Lightweight Kevlar brand fiber / composite shell. Temperature resistance up to 600° F without distorting or melting. Polyurethane impact liner with leather sweatband provides impact and thermal protection. Reflective Trim. High-gloss paint finish. Ratchet headband with easy-to-dial adjuster. 3 point nomex chin strap. Certified NFPA 1951.2007, EN443. ANSI X89.1 Type 2 compliant. Custom lettering with clear coat finish available.

**Weight:** 36.8 oz.

	Color
481434	Red
481436	Blue
481432	Yellow
481439	White



### R5 KIWI RESCUE HELMET

Lightweight DuPont Kevlar® and composite shell weighs less than competitive fiberglass and composite alternatives. Very Lightweight with a small profile for work in confined spaces. 3 point polyester chin strap with quick-release buckle. New scallop-sided shell designed to accommodate a variety of ear muffs. Ratchet headband with easy-to-adjust dial accommodates head size 21.6" - 25.6". One Size Fits most. Light Pod version works best with UK4AA. Complies to AS 1801 and ANSI Z89.1 Type 1.

**Weight:** 19.2 oz. (std)

		Color
4815514	R5 Rescue Helmet	Red
4815516	R5 Rescue Helmet	Blue
4815519	R5 Rescue Helmet	White
Color		
4815524	R5 Helmet, Light Pod	Red
4815526	R5 Helmet, Light Pod	Blue
4815529	R5 Helmet, Light Pod	White



### R3-KIWI RESCUE HELMET

The ultimate in comfort and protection. DuPont Kevlar® shell and full polyurethane impact headliner. Proven in the field by USAR/FEMA and Task Force One personnel. Adjustable Ratchet Headband with multi-point chin strap. Light pod version works best with UK4AA.

**Weight:** 32 oz.

ANSI Z89.1 Type 2 compliant.

		Color
4815314	R3 Kiwi	Red
4815316	R3 Kiwi	Blue
4815312	R3 Kiwi	Yellow
4815319	R3 Kiwi	White
Color		
4815324	R3 Kiwi, Light Pod	Red
4815326	R3 Kiwi, Light Pod	Blue
4815322	R3 Kiwi, Light Pod	Yellow
4815329	R3 Kiwi, Light Pod	White



### WR5 MULTI-USE

*For High Angle and Water Rescue*

Shell made with Dupont Kevlar® with 9 ventilation holes. 6 point suspensions with dial ratchet. 3 Point nylon chin strap with quick-release buckle. Ratchet adjustment expands to 25". ANSI Z89.1 compliant.

**Weight:** 17.6 oz.

481544	WR5 Helmet, Red
481546	WR5 Helmet, Blue
481549	WR5 Helmet, White



### USAR EMS HELMET

*Progressive Design with Flip-Down Visor*

A new lightweight Dupont™ Kevlar® reinforced Jet Style Helmets that offers contemporary style with a high-tech Dupont™ Kevlar® reinforced outer shell. Pacific's Jet styles weigh less than competitive brands and include an internal retractable face shield and a 2 ply Nomex® neck protector as standard features. The Dupont™ Kevlar® reinforced outer shell is backed by a 6-year warranty. The best warranty in the industry!

• Polyurethane impact liner w/ cradle ribbons. • Leather Headband Ratchet style adjuster. • 3 point Nomex Flame retardant chinstrap • Eye Protector 1.5mm w/ nose guard. • Certified to EN443. • Compliant NFPA 1951 USAR

4813119	White
4813116	Blue



### REFLECTIVE HELMET LABELS

Reflective Labels that are a great addition to helmets. Reflectivity adds to safety and identification.

482101	"Rescue" Crescent
482104	"Fire Rescue" Crescent
482103	"Instructor" Crescent
482106	"Rescue Chief" Crescent
482107	"Rescue Squad" Crescent
482108	"Haz-Mat" Crescent
482109	"Chief" Crescent
482212	Stripe, 1" x 4", pair (YE)
482222	Trapezoid, Set of 5 (YE)
482111	Star of Life Decal



Shown on R3 Helmet with Light Pod (not included)

### XTRICATOR™ GOGGLES

For R3, R4, and R5 Rescue Helmets

The ideal solution for primary eye protection for extrication and forcible entry work. Snaps onto the goggle attachment points of the R3, R4, and R5 Rescue Helmets. The ESS X-tricator™ can be stored in a pocket and deployed using the Snap-On/Snap-Off™ helmet mount system, providing the performance of an ESS goggle in seconds. Includes a set of two Tear-Off Lens Covers.

**Weight:** 4.8 oz.

481539G	Xtricator Goggles
---------	-------------------



### VIZIR™

Protective face shield for VERTEX and ALVEO helmets

The VIZIR visor ensures eye protection and integrates perfectly into VERTEX and ALVEO helmets. It is installed easily with its inserts.

- Easy to mount on VERTEX and ALVEO helmets with purpose-built inserts
- Scratch- and fog-resistant

23540115	
----------	--



### VERTEX™ BEST

Helmet for work at height and industry

The adjustment wheel has two height positions and the chin strap can be adjusted for a perfect fit. Side slots and the above-the-ears cut of the shell allow attachment of standard hearing and eye protection. Four clips, on the outside of the helmet, correctly hold a headlamp. Polycarbonate shell, resistant to impact and wear.

**Weight:** 492 gms

Meets CE and ANSI Z89.1 - 2003 -Type I class E.22.4

	Color
2354011010	Orange
2354011011	Black
2354011012	Yellow
2354011014	Red
2354011016	Blue
2354011019	White



### ALVEO BEST™

Lightweight helmet for work at height and rescue

A lightweight helmet for workers at height. Its unventilated shell ensures protection against electrical risks and molten metal splash. CenterFit adjustment system adjusts the headband and keeps it centered on the head.

**Weight:** 350 g

**Head circumference min.:** 53 cm **max.:** 63 cm

- Lightweight with comfort foam
- Shock is absorbed by deformation of the expanded polystyrene liner.
- Inserts for accepting VIZIR face shield
- Slot for Mounting PIXA headlamp
- Four clips for mounting a headlamp with elastic headband
- Available in 3 colors

Certification(s):

CE\*, ANSI Z89.1-2009 Type I Class E

\* - Meets the requirements of the EN 397 and EN 12492 standards for protection against impact. - Meets the requirements of the EN 397 and EN 50365 standards for electrical insulation. - Meets the optional requirements of the EN 397 standard for molten metal splash, lateral deformation and use in low temperatures.

	Color
2354012012	Yellow
2354012014	Red
2354012019	White



### VERTEX™ VENT

Vented for Rescuer Comfort

Comfortable and durable helmet with ventilation, meets requirements for working at height. Adjustable ventilation: 5 holes on each side, can be closed with 2 sliding shutters. Chin strap designed to decrease the risk of losing the helmet in case of impact during a fall. Polycarbonate shell, resistant to impact and wear (meets EN 397 industrial helmet standard and EN 12492 standard). Meets optional requirements of the EN 397 standard: lateral deformation and use at low temperatures (down to - 30 °C).

**Weight:** 465 gm

Meets CE and ANSI Z89.1 - 2003 -Type I class C.

	Color
2354011040	Orange
2354011041	Black
2354011042	Yellow
2354011044	Red
2354011046	Blue
2354011049	White



### ALVEO VENT™

Ventilated helmet for work at height and rescue

A lightweight and ventilated helmet for workers at height. Its ventilation holes allow air to pass through the helmet. Its CenterFit adjustment system adjusts the headband and keeps it centered on the head.

**Weight:** 340 g

**Head circumference min.:** 53 cm **max.:** 63 cm

- Lightweight with comfort foam
- Shock is absorbed by deformation of the expanded polystyrene liner.
- Ventilation holes
- Inserts for accepting VIZIR face shield
- Slot for Mounting PIXA headlamp
- Four clips for mounting a headlamp with elastic headband
- Available in 3 colors

CE EN 12492\*, UIAA, ANSI Z89.1-2009 Type I Class C

\* Meets the requirements of the EN 397 and EN 12492 standards for protection against impact.

	Color
2354012042	Yellow
2354012044	Red
2354012049	White





Shown w/ R5 Rescue Helmet (not included)

### MINI Q-4 HELMET LIGHT

#### Fits Kiwi Light Pods

Extremely bright! Over twice as bright as premium lights of similar size. Provides 4 AA Batteries of power in a light approximating the size of lights containing only 2 AA batteries. Comfortably fits in pocket, briefcase, tool box, and other small places. Optional Helmet mounting brackets attach to industrial, fire, and climbing-style helmets. Burn Time 4-5 hours. Batteries included. FM Approved.

**Dimensions:** 6" x 1.5" x 1" **Weight:** 6.4 oz.

485342	Mini Q-4 Fire (YE)
485349	Spare Bulb for Mini Q-4



### PIXA 2

*Headlamp with mixed beam, designed for close-range work and for movement*

The PIXA 2 headlamp is the hands-free lighting solution for working comfortably at close range and for moving around safely. May be worn on the head, mounted on the helmet, or placed on the ground. It provides constant, stable lighting performance. Two lighting modes: close-range work: mixed beam with wide, uniform base, lights to 20 meters for 12 hours (30 lumens); Medium range: beam with focused component in upper part of the beam allows user to move around comfortably, lights to 30 meters for 6 hours (40 lumens). Reserve lighting when batteries are almost discharged: lights to 10 meters for a minimum of 10 hours. Easy to use, even when wearing gloves: - two-mode rotating selector dial; - lamp body can be oriented to direct the light according to need (rotation up to 45°); - fast and easy battery change. Excellent resistance to falls (2 m), to impacts and to crushing (80 kg). Battery charge indicator flashes repetitive. Resistant to chemicals. Burn time can be doubled by using Lithium Ion batteries or rechargeable Ni-MH batteries. Waterproof to -1 m for 30 minutes.

**Weight:** 160 g

**Battery type (included):** AA/LR6

**Battery compatibility:** alkaline, lithium, rechargeable Ni-MH, rechargeable Ni-Cd

**Certification(s):** - CE - ATEX: CE0080, Ex II 3 GD, Ex nAnL IIB T4 - HAZLOC: class I Groups C & D div II, Class II Group G div II (certifications with alkaline batteries)

2354057802 Pixa 2



### PIXA 3

*Multi-beam headlamp adapted for close-range work, for moving around and for long-range vision*

The PIXA 3 builds upon the features found in the PIXA 2 headlamp and can adapt to any situation encountered on the terrain: close-range work, moving around and long-range vision. May be worn on the head, mounted on the helmet, or placed on the ground. Three lighting modes: - close-range work: wide, uniform beam, lights to 15 meters for 12 hours (30 lumens); - Medium Range: mixed beam with focused component allows user to move around comfortably, lights to 30 meters for 6 hours (40 lumens);

- Long-range vision: highly focused beam, lights to 55 meters for 3 hours (50 lumens). Reserve lighting when batteries are almost discharged: lights to 15 meters for a minimum of 10 hours. **Weight:** 160 g. **Battery type (2 included):** AA/LR6. **Battery compatibility:** alkaline, lithium, rechargeable Ni-MH, rechargeable Ni-Cd. **Waterproof to 1 m for 30 minutes.**

**Certification(s):** - CE - ATEX: CE0080, Ex II 3 GD, Ex nAnL IIB T4 - HAZLOC: class I Groups C & D div II, Class II Group G div II; ANSI/NEMA FL1 (certifications with alkaline batteries)

2354057803 Pixa 3



Shown on Cascade Water Rescue Helmet (not included)

### ESS STRIKETEAM GOGGLES

Designed for Technical Rescue and Wildland Fire Fighting equipped with a thick polycarbonate lens that has been hardcoated and anti-fog treated both inside and out. Soft open cell facefoam designed to fit over most eye glasses. Comes with flame resistant Velcro™ tabbed elastic strap which features instant fit speed clip. Exceeds ANSI Z-87.1 and CSA Z94.3-92.

**Weight:** 6.4 oz.

481601	StrikeTeam XTO
481609C	Replacement Lens, Clear
481608	Tear Off Lens Covers



### HELMET LITE HOLDER

Multi-directional adjustable light holder. Three piece set designed to fit all hard hats and fire helmets without drilling or gluing. Attaches to either left or right side and does not interfere with visors. Fits VersaBrite, VersaBrite II, Mitylite and Stealthlite and Mini Q-4.

4870700	Polycarbonate
4870760	Stainless Steel



### HEADS UP LITE

*Watertight to 500 Feet*

Adjustable beam with large on/off switch. Corrosion proof ABS polymer. 4 AA-cell Alkaline Batteries included. Heat resistant hypo-allergenic silicone rubber strap. Head rotates up and down - special ratchet system holds light in place. Ideal for hard hats and helmets. Includes one high and one low intensity krypton lamps.

**Color:** Black **Weight:** 5.4 oz.

UL approved intrinsically safe, CL I, Div. 2, Group ABCD, T3C)

4872600RS Heads Up Lite



### EOS II LED



The EOS is optimized for both close-up and distance needs. The combination of a Luxeon/1 watt L.E.D. and a special lens maximizes the beam by balancing long throw with flood light. The EOS provides a self-contained 3AAA battery system that eliminates external wires, and is equipped with (3) brightness levels. Each level provides true current regulation ensuring that the EOS will remain at constant brightness as long as the batteries have sufficient voltage. Durable and water resistant to water. **Weight: 3.7 oz with Batteries (Included). Waterproof to 1 Meter. Burn Time: High: 6.5 Hours; Medium: 12.5 Hours; Low: 60 Hours.**

UL approved intrinsically safe, CL I, Div. 2, Group ABCD

21851051	EOS II LED
2185105	EOS LED



### APEX LED

The Apex LED Headlamp will light up your Rescue world. The 3-watt MaxBright LED (130 lumens) will shine a spotlight beam up to 180 feet away and the four Ultra-bright LEDs will cast a steady wide beam or flashing light out as far as 75 feet. All this power in a 10-oz. package that squeezes 72 to 200 (average 150) hours of light out of four AA alkaline batteries (included). Waterproof to 1 Meter. The dual switch design allows easy access to the five modes. Submersible to 3-feet, works with alkaline, lithium or rechargeable batteries.

UL approved intrinsically safe, CL I, Div. 2, Group ABCD, T3C)

2185101	Apex LED
---------	----------



### APEX PRO LED

The Apex Pro lightweight is a must where ultimate power and function are a demand, and durability is an expectation. In an effort to meet the unique and ever evolving needs of rescuers, The Apex Pro was developed to provide a faster and lighter option while still providing the ultimate in brightness and output. The Apex Pro is powered by 2 CR123 lithium batteries protected in a highly durable and waterproof case. 6 power modes.

**Burn Time: High Power:** 15 hours

**Low Power:** 35 hours

**Batteries:** 2 x CR123 Lithium

**Weight:** 173 gm

UL approved intrinsically safe, CL I, Div. 2, Group ABCD, T4)

		Color
2185300	Apex PRO LED	Orange



### HEADS UP DUAL



*Xenon / LED Combination*

The Dual combines Pelican's bright Xenon headlamp with a long-lasting set of three (3) LED lamps. Switch controls Halogen and LED lamps. Tilt head offers 90° adjustment. Runs on 3 AA-cell batteries (included). Runs 3 hours on the halogen lamp and 50 hours on the LEDs. Complete with rubber strap.

**Color:** Black **Weight:** 4.9 oz.

UL approved intrinsically safe, CL I, Div. 1, Group CD, T3C)

4872620RS	Heads Up Dual
-----------	---------------



### YUKON HL HEADLAMP

Hybrid L.E.D. Technology employs state of the art, 1-watt L.E.D. and 3 high output, 5mm L.E.D.s. The 1-watt L.E.D. rivals the output of incandescent bulbs. For long burn time switch to the 3 L.E.D. array. 10,000 hour bulb life and burn times of 44 hours from the 1-watt L.E.D. and 120 hours from the 3 L.E.D. array.

UL approved intrinsically safe, CL I, Div. 1, Group ABCD, T3C)

488145HL	Yukon HL Headlamp
----------	-------------------



### QUAD HEADLAMP

Four Ultra-bright LEDs power through the darkest conditions. Tough waterproof housing that will survive severe impacts and water submersion up to one meter. Four LED bulbs operate in high, medium, low and flashing modes. Battery power meter with 24 hour burn time on high setting and 47 hour burn time on low setting. Water proof to one meter.

UL approved intrinsically safe, CL I, Div. 2 Group ABCD

UL approved intrinsically safe, CL 2 Div. 2, Group FG

2185201	Quad Headlamp
---------	---------------



## PRO RESCUE GLOVE

Mesh Back / Leather Palm

The Pro leather gloves are perfect for those jobs that are especially hard on the hands. When anything less than a leather glove won't do. Top quality leather construction throughout. Leather knuckle panel provides increased protection. Easy entry, wide opening elastic cuff (Easy-Fit design). Anatomically-cut, leather palm and heel reinforced panels for extended durability. Smooth surface thumb improves handling of objects. Reinforced thumb and fingertips increase protection and reduce wear.

Weight: 4.8 oz.

	Color	Size
491221	Black	S
491231	Black	M
491241	Black	L
491251	Black	XL
491261	Black	XXL

	Color	Size
491222	Tan	S
491232	Tan	M
491242	Tan	L
491252	Tan	XL
491262	Tan	XXL



## HEAVY RESCUE GLOVE

Cowhide shell/Cowhide Wear Pad

Glove design incorporates double palm with wear pad extending up the individual fingers and thumb and around to the back of the hand, leaving a single layer at the finger tips for superior tactile capabilities. This protective design utilizes no loose flaps or webs between the fingers that can trap dirt or roll up during use. Flexible design permits ease in rope handling. Leather loop allows for attachment to carabiners.

Color: Black Weight: 5.6 oz.

	Size
490521	S
490531	M
490541	L
490551	XL
490561	XXL



## BARRIER 1 EXTRICATION GLOVES

A great new extrication / rescue glove. Waterproof and breathable Hipora® barrier to protect hands from micro-organisms such as TB, Hepatitis, Staph and HIV meets O.S.H.A. Bloodborne Pathogens Standards (29CFR 1910.1030). Boxed finger tip design for better fit and comfort. Elastic cuff and gaiter to keep out glass and debris. Molded TPR (Thermal Plastic Rubber) knuckle reduces impact, increases dexterity and features 3M™ Reflective fabric. Molded TPR finger knuckle and finger tip panels. Cut resistant Kevlar® palm and thumb panels, side panels and finger panels. Kevlar® stitching in high wear areas.

	Color	Size
202232708	High-Viz	S
202232709	High-Viz	M
202232710	High-Viz	L
202232711	High-Viz	XL
202232712	High-Viz	XXL
202232713	High-Viz	XXXL

	Color	Size
202232308	Black	S
202232309	Black	M
202232310	Black	L
202232311	Black	XL
202232312	Black	XXL
202232313	Black	XXXL



## RINGERS ROPE RESCUE GLOVES

Omni-directional stretch fabric offers flexibility and excellent airflow. Palm manufactured of Armortan® leather that can be machine washed to remove contaminant. Double thickness in palm with DuPont Kevlar® thread for long wear. Reinforced finger tip and thumb extends glove life. Precurved ergonomic shape and anti vibration gel padding for extra comfort.

Weight: 4.8 oz.

	Color	Size
4907X1	Black	SM - XXL
4907X4	Red	SM - XXL



## RIGGING GLOVE

Mesh Shell / Amara™ Palm

Breathable Mesh for increased ventilation. Smooth surface thumb and index finger improve handling of objects. Reinforced thumb and fingertips increase protection and reduce wear. Neoprene knuckle panel provides increased flexibility and protection. Anatomically cut, foam-padded palm lessens impacts and reduces vibration. Soft, flexible, durable and breathable synthetic leather palm. Easy entry, wide opening elastic cuff. Pull cord on wrist for easy entry and for hanging gloves after use.

Weight: 3.2 oz.

	Size
490221	S
490231	M
490241	L
490251	XL
490261	XXL



## LEATHER 3/4 FINGER GLOVE

Genuine leather, extra gel-foam padding in palm. Great for rigging and stagehands. 2-way stretch spandex top. Flexible, soft, durable and breathable leather palm.

Weight: 3.2 oz.

	Size
4906121	S
4906131	M
4906141	L
4906151	XL
4906161	XXL

### RescueTECH Glove Sizing

Measure around widest portion of the hand.

XSmall	5 - 7"	Large	9 - 10"
Small	7 - 8"	XLarge	10 - 11"
Medium	8 - 9"	XXLarge	11 - 13"





### ELASTIC GLOVE CINCH

Manufactured from durable stretch cord and high quality cordlock. Elastic holds gloves in place. Girth-hitch this Cinch around gear loops, waist belts, and D-rings to keep gloves ready to use.

491902 Elastic Glove Cinch



### GLOVE STRAP

with Steel Trigger Snap

Manufactured from durable nylon webbing with plated steel trigger snap. Closes around glove with quality hook and loop fastener.

491901 Glove Strap



### LATEX GLOVE POUCH

Made from our high quality nylon fabric and top grade hook and loop fastener. Holds multiple pairs of gloves.

833001 Latex Glove Pouch



### USAR KNEE AND ELBOW PADS

Great for use in building collapse searches. Velcro closure and tough cap. Provides heavy duty protection for the toughest jobs.

		Weight
481611	Knee Pad, pair	13.7 oz.
481621	Elbow Pad, pair	7.2 oz.



### EMT SHEARS POUCH

A new design from Rescue Technology. Made from Durable Magnatuf coated nylon fabric. Features glove pouch, shears pouch with hook and loop keeper and a pouch for penlights, pens, etc. Fits onto belts with a quick removable snap system. A plus for safety.

Shears not included.

833010 EMT Shears Pouch



### SEAT BELT CUTTER

A lightweight seat belt cutter. Will easily cut through webbing and cords with ease. Manufactured from high impact plastic with hardened stainless steel blade.

Dimension: 4.75" x 1.75" Weight: 1 oz.

630101 Seat Belt Cutter



### EMT SHEARS

Safer than a knife when used around ropes. Safety bandage tip. Stainless Steel Blades. May be placed in Autoclave. Cuts clothing, ropes, or harnesses. Stainless Steel blades with polypropylene handles.

Length: 7.5" Weight: 2 oz.

		Color
6301051	EMT Shears	Black
6301052	EMT Shears	Yellow





### WINGMAN

The Wingman Knife's flip-out blade fulfills your need for speed. Its safety features help you break out of the danger zone. Easily deployable one hand flip-open blade for when you feel the need for speed. Knife has a blunt tip and both smooth and serrated blade sections. The blade locks open for safety and the handle has a blunt glass-breaking tip. Removable spring steel clip is always ready for action when secured to a belt or lash tab.

20842771 Wingman



### RESCUE HOOK

Form and function same time and effort for the rescuer. Manufactured of 440C stainless steel with a molded Kytex sheath.

**Overall Length:** 2.90"  
**Blade Length:** 0.85"  
**Blade Thickness:** 0.115"

2282327040 Rescue Hook



### SPYDERCO RESCUE KNIFE

VG-10 blade steel and fully serrated with a sheepfoot tip. Large thumb hole with texturing behind it and the FRN volcano grip textured handle.

**Blade thickness:** 1/8"

	Length	Length	Color
2282376553	7 1/8"	79mm	Orange
2282376530	8 1/8"	93mm	Black



### KERSHAW BLUR SERRATED

The Blur's handle is built from anodized 6061-T6 aluminum with "Trac-Tec" inserts for an extremely secure grip even in the most damp or slippery conditions. The blade is made out of 440A stainless steel and measures 3". Easy opening with Speed Safe technology. Folded, the blade measures 4.25" and weighs in at a comfortable 4 oz.

2282376796 Serrated (Black)  
 2282376797 Serrated (Red)



### E-Z OUT RESCUE

The E-Z Out Rescue features a blunt tip design on the fully serrated sheep foot stainless blade that makes this knife safer to use in situations where you don't want to risk puncture. Features a yellow handle with black Kraton® non-slip rubber inserts, removable pocket clip and lock back.

**Closed:** 4.62" **Blade:** 3.5"  
**Weight:** 2.6

2282376647 E-Z Out Rescue



### SPYDERCO ASSIST RESCUE KNIFE

*With Glass Breaker*

Made for the fire/rescue professionals, the Assist features a carbide glass breaker, sure grip FRN handle, 80% serrated blade, VG-10 high-carbon blade steel, survival whistle built into the handle and wire clip. Blade and handle shape are designed to allow controlled rope cutting without an exposed cutting edge. Place the rope between the partially closed blade and the handle then squeeze the blade shut.

**Length:** blade 3.69" **closed:** 4.875"  
**Weight:** 4 oz.

2282376549 Assist

### GERBER HINDERER

It took a fire fighter with a genius for knife design to conceive this feature-rich rescue knife. And Rick Hinderer did himself proud. He's integrated some of the most important features a fire fighter will need. Even while wearing turn-out gloves, using this knife will not be an issue. The knife has larger, beefier features and mechanisms built-in. This is no ordinary rescue knife. The Hinderer Rescue Knife has a heavy duty, 440A stainless steel blade with an external blade release. Additional features include an oxygen tank wrench, safety hook cutter, window punch, lanyard hole and an oversized thumb stud for easy opening. And it comes with a 9-piece tool kit. The belt case can be worn vertically or horizontally.

**Blade Length:** 3.5" (89mm) **Open Length:** 8.5" (215mm)  
**Weight:** 5.6 oz. (158g)

243601534 Gerber Hinderer





## SUPER SABRELITE

### Industrial Quality Work Light

Used by Army and Navy strike teams. High-tech Xenon Laser Spot provides four times the useable candle power of ordinary C & D size flashlights. Unbreakable ABS body with a high impact polycarbonate lens. Includes belt spring clip, stainless steel split ring and black lanyard. Meets Military specifications. Requires 3 C-cell batteries.

**Dimensions:** 7.75" x 1.875" **Weight:** 6.5 oz.

UL Class 1, Div. 1 Approved. FM, MSHA, CSA, AUS, and USAR approved non-incendive.

	Color
48720001	Black
48720000	Orange
48720002	Yellow
4872004	Xenon Lamp Module



Clip for windows and cones

## E-FLARE™ 500

E-Flare 500 Series: Professional HZ Model

• Rubber Base Included • Fluoro Yellow Body Color • Bright Clear Colors. • Low Battery Indicator • Designed for use in Class I, Div 2/Zone 2 Hazardous areas • 80 hour battery life

23625004	E-Flare, Red
23625002	E-Flare, Amber
23625006	E-Flare, Blue
2362500C	Mounting Clip
2362500M	Mounting Bracket, Magnetic
2362500B	Rubber Base



## STEALTHLITE

Watertight to 500 feet. Unbreakable ABS body with high impact polycarbonate lens. State of the art Laser Spot Xenon lamp module. Includes one-handed safety switch operation, double shock mounted battery compartment, and black lanyard. Operates 5 - 6 hours on 4 AA-cell alkaline batteries (not included.)

**Weight:** 5.3 oz.

FM, CSA, USAR approved. Class I, Div. I, Group D.

48724001	StealthLite (Black)
48724002	StealthLite (Yellow)
4872404	Xenon Lamp Module



## LITTLE ED™ RECHARGEABLE RECOIL LED™

The Recoil uses a 1 watt LED that's aimed backwards into the reflector. 100% of the light is captured and aimed forward as a tight collimated beam that's as bright as an incandescent. The body is made of tough ABS resin that's corrosion proof and resistant to extreme temperatures. It uses a long-life NiMH battery pack for extended burn time and comes with a charger base unit that can be installed at home or work using the 110V transformer.

**Packaged Weight:** 1.7 lbs.

48736602	Little Ed, Rechargeable	\$166.00
----------	-------------------------	----------



Shown: LZ Kit, Red/Blue

## E-FLARE™ 5 STROBE LZ KIT

5 Strobe E-Flare LZ Kit. Kit includes 1 Blue and 4 Amber or Red Strobes.

23625100	E-Flare LZ Kit, Amber/Blue
23625104	E-Flare LZ Kit, Red/Blue



## TORRENT LED

Power meets versatility in the Torrent LED. With a 126 Lumen Maxbright LED it's got the power to be a main light source. A simple switching mechanism and a 100-meter waterproof rating ensure that the Torrent LED will be shining bright whenever and wherever you need it to go.

**Power:** 126 Lumens **Lamp:** Maxbright LED

**Burn Time:** 30 Hours **Batteries:** 8 AA Alkaline (not included)

**Weight:** 365 Grams

UL RATING APPROVED

Class I Division 2 Groups A, B, C & D

218520102	Torrent LED
-----------	-------------



## SHOCKWAVE LED

400 Lumens of PTEC power that's built to go 100 meters below the surface. With two modes of illumination, you can choose between full-power and extended-battery mode. Whether you need spotting at a distance or close range lighting, the Shockwave LED is the biggest, baddest, brightest light you can buy. Batteries not included.

**Power:** 400 Lumens **Lamp:** 3 Maxbright LEDs

**Burn Time:** 26 Hours **Batteries:** 8 C Alkaline

**Weight:** 1075 Grams

UL RATING APPROVED

Class I Division 2 Groups A, B, C & D

2185803102	Shockwave LED
------------	---------------



# FIELD OPERATIONS

## RESCUER ASSISTANCE & COMMUNICATION

All teams performing Search and Rescue in Urban, Suburban and rural areas benefit from the capabilities of hardwire communications and remote cameras. Con-Space is the preeminent manufacturer of top quality search products. From their original hardline communications kits to the Delsar life detectors to the Searchcam remote camera products, you can be sure of the quality and durability of Con-Space products. Used by USAR teams worldwide.



## CON-SPACE COMMUNICATIONS SYSTEMS

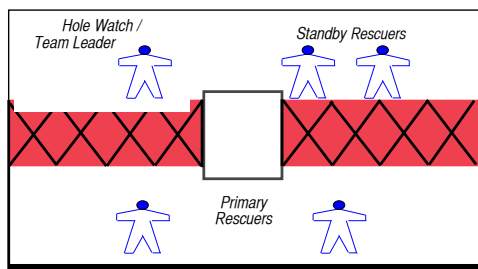

### RESCUE COMM KIT 1

Configured for a team of five rescuers consisting of two primary entrants, two standby entrants and a safety attendant. Includes 100' of cable for each entrant (expandable to 1500 ft.). System can be configured for up to ten people using available modules and accessories.

**Weight:** 49 lbs.

**304011P** Rescue Kit 1, Power Talk

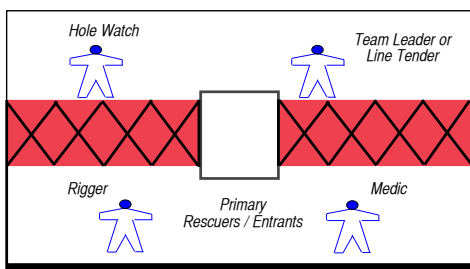

### RESCUE COMM KIT 2

Configured for a team of four people consisting of two entrants, a safety attendant and a team leader. Includes 100' of cable for two entrants (expandable to 1500 ft.). System can be configured for up to ten people using available modules and accessories.

**Weight:** 40 lbs.

**304012** Con-Space Rescue Kit 2

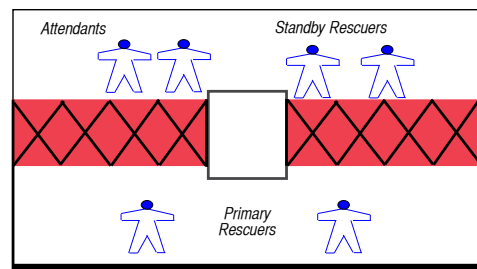

### RESCUE COMM KIT 5

Configured for a team of six rescuers consisting of two primary entrants, two standby entrants and two attendants. Includes 100' of cable for each entrant (expandable to 1500 ft.). System can be configured for up to fourteen people using available modules and accessories.

**304015P** Rescue Kit 5, Power Talk



### USAR TASK FORCE COMMUNICATION KIT

A multi-use Urban Search and Rescue Task force Kit designed to meet the needs of Confined Space, High Angle, Structural Collapse, Victim Location, Shoring, Tunneling and Trench Rescue. The USAR Kit can be configured according to the type of rescue involved, so whether it's a two-in-two-out or a five person Search and Rescue team this kit has you covered. Intrinsically Safe.

3034055 USAR Task Force Comm Kit



### VICTIM LOCATOR KIT

*Confined Space Rescue Probe*

For structural collapse - includes the unique CON-SPACE Rescue Probe designed to detect and communicate with victims trapped in collapsed structures. Intrinsically Safe Approved.

30310031 Victim Locator Kit



### BOMB DISPOSAL KIT

Private communications for team of 3 Bomb Specialists wearing Face Shields and Full Body Armor. System is NON-RF emitting - conforms to MIL-STD 461. Intrinsically Safe Approved.

30310030 Bomb Disposal Kit



### DELSAR LIFE DETECTOR LD3

Rescue teams around the world have relied upon the LifeDetector for over 15 years to rapidly detect and locate victims of collapsed buildings. The LifeDetector essentially converts the entire collapsed structure into a large sensitive microphone to pinpoint signals from the entombed victims. The seismic and acoustic sensors of the system convert vibrations created by the live victim into audible and visual signals.

• *Improved color-coded cable connectors* • *Allows two acoustic search probes to be used simultaneously for stereo comparison.* • *Audio loop record function records last five minutes of audio for playback and comparison.* • *Display panel shows relative signal strength of all six sensors simultaneously.* • *Peak meters indicates highest amplitude reached by each sensor.*

21709920306	6 Sensor
21709920304	4 Sensor
21709920302	2 Sensor
21709920311	Delsar Victim Simulator

### DELSAR USAR SEARCH KIT

The New Delsar USAR Kit combines the Delsar Life Detector Six Sensor System and the Delsar Victim Simulator, together in one ready to deploy case. The Victim Simulator is an excellent training tool for victim search and rescue, but also doubles as a valuable calibration unit for the Delsar's Seismic Sensors for use on different surface materials. Used by FEMA, UKSAR, USAR, SUSAR and rescue teams from around the world, the Delsar USAR Kit is a seismic/ acoustic listening device used to detect and locate live victims trapped in:

- *Collapsed structures caused by earthquakes*
- *Explosions*
- *Landslides*
- *Mine disasters or cave-ins*

The Delsar USAR Kit converts the entire collapsed structure into a large sensitive microphone that transmits noises from entombed victims. The seismic and acoustic sensors convert vibrations created by the live victim into audible and visual signals. The Delsar is rugged, reliable and able to withstand days of continuous use at the disaster site.

21709920320 Delsar USAR Kit





### HOSE/CABLE UMBILICAL

*Zippered in Multiple Colors*

New style zippered hose / cable protections. Four colors to allow accurate selection of hose/ cable/lifeline combinations.

50'	Color	100'	Color
303010501	Black	303011001	Black
303010500	Orange	303011000	Orange
303010502	Yellow	303011002	Yellow
303010506	Blue	303011006	Blue
303010504	Red	303011004	Red



### CABLE AND ACCESSORIES

30204050	50' w/ Connector
30204100	100' w/ Connector
30311050	50' w/ Strain Relief Hook (shown)
30311100	100' w/ Strain Relief Hook

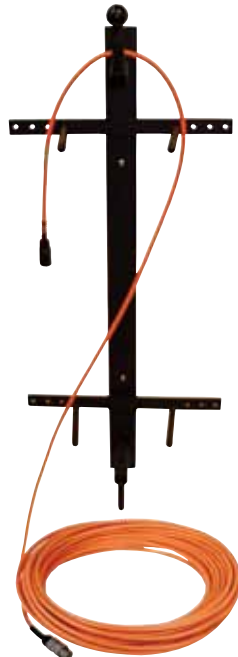

### CON-SPACE CABLE COILER

Coils your CON-SPACE Hardline Communication Cable through a unique figure 8 looping system that allows for simple, untangled deployment in the field. Cable not included. Creates coils that are 29" x 7".

**Dimensions:** 32" x 14"

30301040	Con-Space Cable Coiler
----------	------------------------



### CABLE / AIR HOSE REEL

Communicate while reeling in or out. Cable is fully protected, easily handled, and safely stored. Cable & Hose not included.

30120520	200 ft. Reel with Wheels
30120530	300 ft. Reel with Wheels



### CABLE REELS

Communicate while reeling in or out. Cable is fully protected, easily handled, and safely stored. Cable & Hose not included.

30120225	250 ft. Reel
30120250	500 ft. Reel



### CON-SPACE CABLE BAG

Stores and allows for easy transport of your Hardline Cable. Holds 100 ft. - 300 ft. of Con-Space Cable. Cable not included.

**Dimensions:** 32" L x 11" W x 6" H

30303007	Con-Space Cable Bag
----------	---------------------





Shown with HT-1250 Radio. (Not included)

### DOUBLE RADIO CHEST HARNESS



Same suspension and adjustment as the Deluxe Radio Chest Harness. Carries two radios, one on each side of platform with a center pocket for extra batteries, etc. Second radio pocket can also carry GPS unit or cell phone.

**Weight:** 12 oz. **Color:** Black

820321 Double Radio Harness



Shown with HT-1250 Radio. (Not included)

### MESH RADIO CHEST HARNESS



*Lightweight, Breathable*

A lightweight version of our Deluxe Radio Chest Harness. Adjustable webbing shoulder straps with quick-adjust elastic chest strap. Mesh provides excellent ventilation for hot climates. Elastic loops hold pens, flashlights, etc.

**Color:** Black **Weight:** 7.2 oz.

820305 Radio Chest Harness



### HARNESS RADIO HOLSTER

A holster that puts your hand-held radio where you need it – on the shoulder strap of your harness. Fully adjustable for radio circumference and height. Attaches with high strength hook and loop. User adjustable elastic sizes for the height of the radio and closes with a high strength Snap. Shown with HT1250 (not included)

820307 Harness Radio Holster



Shown with HT-1250 Radio. (Not included)

### DELUXE RADIO CHEST HARNESS

One-Size-Fits-All radio harness will adjust to hold any radio snugly to your chest. The vertical orientation of the radio improves reception, extends antenna life, and reduces the chance of chest injury during a fall. The unique suspension system of 1.5" webbing shoulder straps and elastic chest strap, virtually guarantees that the harness will not bounce or swing, even while crawling through confined spaces. Twin buckles ease the donning of the elastic chest strap. The harness features a large bellows cargo pocket, pen pouch, and twin elastic antenna keepers.

**Color:** Black **Weight:** 9.6 oz.

820301 Deluxe Radio Chest Harness



## SEARCHCAM 3000™

*The new standard for Technical Search and Rescue Cameras*

Lightweight and portable, the SearchCam 3000 is constructed using aircraft aluminum with a hard anodized finish. The interchangeable tube sets connect using threaded couplers - enlarged to ensure easy of use while wearing gloves. The unit features significant improvements over the SearchCAM 2000.

Record Video, Voice and Still Images. Detachable head is waterproof and can be lowered into dusty, harsh and wet void spaces. Articulating camera head is power driven with a high precision, clutch protected motor with steel gears and ball bearings.

### Components Included:

- Power Module • Standard Tube Set • Gearbox/Audio module • Environmental Sleeve for Audio Module • Color Camera • Video display Unit VDU • Headset • 4GB SDHC Card
- Waterproof Storage case • 75' Camera Extension Cable • 70' rope w/ Carabiner • Camera Head Rope Coupler • Lithium ION Batteries (4) • Gang Charger • Sun Shield • Tube Strap
- VOID Orientation Guide

21709930001

Probe w/ Audio



## CON-SPACE HASTY SEARCH KIT

The HASTY SEARCH Kit™ has been specifically configured for urban search & rescue teams, "enhanced" rescue squads, regional task forces and SUSAR teams who are seeking a high quality, easy to use, cost effective, all-in-one technical search system for their standard equipment cache. The Hasty Search Kit comes complete in one easy to store case and is designed to be both easily transportable and rapidly deployable anywhere disaster strikes.

The Kit includes the Delsar® LifeDetector® Mini system that provides seismic detection of victims and the all new SearchCam Recon III for visual search and location operations.

21709922001

Con-Space Hasty Search Kit



## RECON III SEARCH CAMERA

The Recon III camera has been completely re-designed to provide unparalleled reliability, durability and ease of use to meet and exceed the operational requirements of a rescue squad or medium/light USAR capability. Building upon the success of the popular Recon II, the Recon III fits today's demanding requirements and more demanding Budgets. The New Recon III is affordable, versatile and ready to go! The Recon III utilizes a 240 degree articulating camera head with variable high output LED lighting to achieve effective visual searching as close as a few inches to over 10 feet (3m) in total darkness. The display is attached to the control housing with a quick connect fitting and can be easily removed to extend the cameras reach. Articulation is accomplished by rotating the large glove friendly drive collar. The pistol grip handle makes positioning and handling intuitive and provides an easy reference for camera head orientation. The lack of external wires and belt packs make the Recon III camera extremely maneuverable and portable. The Recon III is compatible with batteries and chargers of the SearchCam 3000 and Delsar LD3 and Delsar Mini Systems to aid with logistics on a large scale event. The Recon III is designed for rescue squads that understand the value of an adaptable visual search tool that can be used in a wide variety of operations and want the quality and features found only in a SearchCam product.

21709920103

Recon III Search Camera



## SEARCHCAM MONGOOSE

The SearchCam Mongoose is a small, compact video inspection camera used for victim extraction. Rescue workers rely on this entry-level, lightweight camera to locate victims in structural collapse, breaching and vehicle extrication operations. The Camera is also available as an accessory configuration to the SearchCam 2000. **Probe weight: 3 lbs.** Includes custom foam-lined case.

21709920121

Mongoose Probe w/ Audio

21709920011

Victim Simulator



## RAMFAN UB20

### 8" Blower System

Provides the industry's highest certified CFM for either exhausting or discharging air with 8" duct.

Easily attached 15 - 25 ft. duct canister works at either end or both ends. The UB-20 has RAMFAN's uniquely designed turbo blade which creates a straight, non-spiraling airflow. Motor: 1/3 hp, 60 Hz, 115 - 230 VAC, 2 amps. Optional DC motor. Manufactured of Double Wall lightweight, rugged polyethylene.

**Dimensions:** 13" H x 12" W x 13" D **Weight:** 16 lbs.

Performance measured by CEESI.

Airflow		
Freeflow	1-90°	2-90°
980 cfm	789 cfm	666 cfm

3270015	AC Blower w/ 15 ft duct
3270025	AC Blower w/ 25 ft duct
329015	DC Blower w/ 15 ft duct
329025	DC Blower w/ 25 ft duct
325508	AC Blower ONLY, 115 v
329002	DC Blower ONLY, 12 v
3203605	DC Battery Connector, 5 ft.
32034214	UB20 DC Battery Pack Charger



## RAMFAN ACCESSORIES

### 8" Duct

320815	Standard Duct, 15 ft.
320825	Standard Duct, 25 ft.
320815C	Conductive Duct, 15 ft.
320825C	Conductive Duct, 25 ft.
3210108C	Duct Coupler, 8"

### 12" Duct

3211215	Standard Duct, 15 ft.
3211225	Standard Duct, 25 ft.
3212215	Conductive Duct, 15 ft.
3212225	Conductive Duct, 25 ft.
3210112C	Duct Coupler, 12"
321014	Storage Bag, 8" x 15' / 25' or 12" x 25'
321015	Storage Bag, 8" x 25' Conductive



## RAMFAN UB30

### 12" High Output Blower

A new 12" RAMFAN is born. Building on "UB" technology, the patent-pending UB30 is simply the toughest, most durable, easy to maintain and versatile blower in its class. Unmatched performance, dual voltage-dual frequency versatility, tough polymer shell and turbo-impeller design makes for an unbeatable package.

**• Thermal Switch provides Overheat Protection • IP65 Rain Tested Switch Enclosure • Ultra Quiet Operation • Low Starting Amps • Stackable Design Feature**

UB30 Shown with 12"-8" Duct Adaptor

Airflow		
Freeflow	1-90°	2-90°
2,873 m3/hr	2,550 m3/hr	2,340 m3/hr

329102	12" UB30 Blower
3210112	12" - 8" Duct Adaptor



## RAMFAN M.E.D. 8" BLOWER SYSTEM

### Complete Confined Space System

Ready-built system for your confined space team. Available with Standard UB20 Blower or UB20XX Extreme hazard Blower and 5 ft. and 15 ft. duct.

220370152	20' System
327025XS	20' Hazard System
327025XS-K	20' Hazard System w/ Kil-Arc Plug



## RAMFAN EXTREME HAZARD BLOWER

Same high quality blower mechanism as the standard UB20 with a conductive housing and duct. When properly grounded, the system virtually eliminates static discharges. Manufactured with Anti-Static housing. Totally enclosed hazardous location motor rated UL Class I, Group C,D; UL Class II, Group E,F, G. 30 ft. Cord w/ power switch. Plug not included.

**Blower Dimensions:** 13" H x 12" W x 13" D

**Blower Weight:** 21 lbs.

Performance measured by CEESI.

3270115	8" UB-20XX w/ 15 ft duct AC
3270125	8" UB-20XX w/ 25 ft duct AC
3270102	8" UB-20XX Blower ONLY
327512X	12" Efi75XX Blower ONLY
3270115XK	UB-20XX w/15 ft duct/Kil-Arc Plug
3270125XK	UB-20XX w/25 ft duct/Kil-Arc Plug

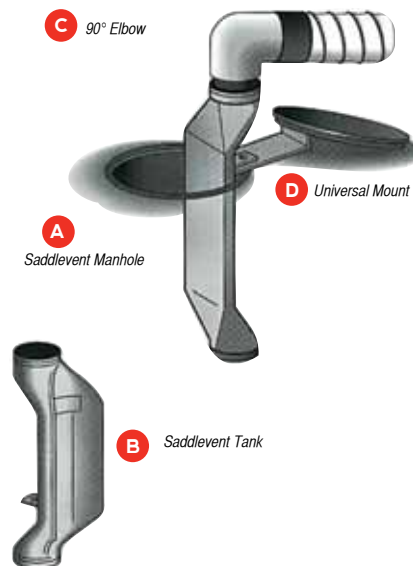

## SADDLE VENT

For Use With 8" Duct

A. 3220189	Manhole, Std.
A. 3221189X	Manhole, Conductive
B. 3220189T	Tank, Std.
C. 3220190	90° Elbow
C. 3221190X	90° Elbow, Conductive
C. 3220190T	90° Elbow, Tank Style
D. 322098	Universal Mount



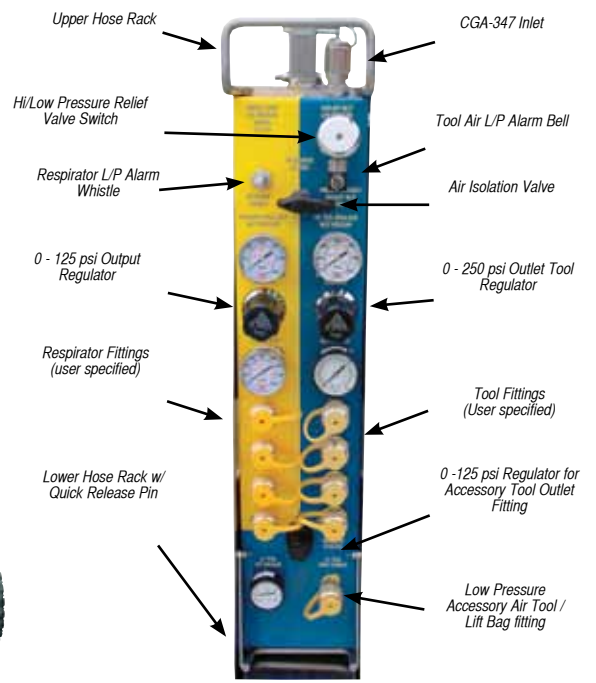

### TECHNICAL RESCUE AIR CART

#### Simultaneous Respirator and Air Tool Operation

Separate high (275 psi) and low (125 psi) pressure regulated air systems. Additional high pressure inlet port allows connection to outside air source for extended use applications. High pressure isolation valve and toggle switch allows user to switch between common or isolated air sources. Operable via cylinder air or mobile air truck. The system includes two connecting hose whips with bleed valves and inline check valves, adjustable heavy duty high flow pressure regulator with relief valve, dual pressure gauges for cylinder and outlet pressure readings, low cylinder pressure alarm, breathing air manifold with quick-disconnect Hansen couplings. 275 psi or 125 psi pressure relief valve. 3 way selector valve allows operation with left cylinder, right cylinder, or High Pressure Inlet. Dimensions: 35"H x 20.5" W x 15" D. Weight: 54.5 lbs (without cylinders). Respirator Regulator: 0 - 5500 psi inlet; 0 - 125 psi outlet. Tool Regulator, High Pressure: 0 - 6000 psi inlet; 0 - 275 psi outlet. Tool Regulator, Low Pressure: 0 - 300 psi inlet; 0 - 125 psi outlet. Flow Rate: 80 cfm @ 120 psi. Outlet Fittings: four (4) 1/4" Quick-Disconnect Fittings. Accepts cylinders up to 4500 psi pressure rating.

Exceeds NIOSH guidelines for point of attachment.

2009114H	Technical Rescue Cart, 1/4" Hansen Fittings
2009225	25 ft. High Pressure Connect Whip (for Cascade)
2009119	Cart Cover



### MACK NFPA AIR MANIFOLD

#### Air Distribution System Designed Specifically for Confined Space Rescue Teams

The MACK-NFPA series has been developed specifically for the Fire/Rescue teams working under NFPA guidelines. Two separate regulator/manifold systems provide 0-125 psi air to a four outlet respirator manifold. Two SCBA connect whips are provided for each regulator for SCBA cylinder attachment (not included). In the event of regulator malfunction, rescue can be performed on the standby regulator system. A CGA-347 high pressure inlet is also provided to allow continuous operation from truck mounted air cylinders. Low pressure alarm whistle and a 6 volt DC lamp to illuminate the case interior are standard. The MACKNFPA3, has a regulator isolation valve added to allow one or both air sources to be used simultaneously.

- Dual independent regulators with two 3-outlet manifolds • Dual low pressure alarms • 4 each 5 ft. connect whips • Regulator Isolation Valve • CGA-347 High Pressure Inlet

2009133NH	MACK-NFPA 3, Hansen Fittings
-----------	------------------------------



### AIR SUPPLY HOSE

High quality air supply hose with Hansen fittings to fit the Technical Rescue Air Cart.

20095457H	50'
20095458H	100'

## Ordering Instructions

1. Use catalog numbers and descriptions. This will help us correctly and promptly fill orders.
2. Remember to indicate size, color, and length, where applicable.
3. We ship UPS but will mail parcel post or utilize motor freight at the request of our customers.
4. Order line: 800-334-3368, for information call (770) 832-9694. FAX (770) 832-1676.
5. Our office hours are 9:00 a.m. - 5:00 p.m. (eastern). FAX operates 24 hour per day.

NOTICE: By placing an order the customer acknowledges agreement with the terms and conditions stated below, and acknowledges having read and understood the important warnings in this catalog. The customer further agrees that the laws of the state of Georgia shall apply to the purchase or any dispute arising therefrom.

## Shipping Information

All products are sold F.O.B. shipping point. Shipping charges for retail customers inside the U.S. will be approximately 7% of merchandise cost: \$8.00 minimum. A \$8.00 charge will be added to COD shipments. A handling charge will be added to all shipments to cover insurance and carrier accessorial charges. Single items weighing over 70 lbs. will be shipped via most cost effective method.

## Payment Policy

Purchase orders are accepted from government agencies, cities, and municipalities. Business and volunteer organization purchase orders are accepted if an open account has been approved by our credit department. All orders from individuals require Visa, Mastercard, COD, or check with order. Please allow time for your check to clear your bank. Prices are in U.S. dollars and are subject to change without notice. Sales tax is added to all orders shipped to Georgia addresses. Billing discrepancies must be reported within 10 days of invoice date. Returned checks subject to \$30.00 fee.

## Damaged Shipments

If the shipping container is damaged, immediately open the carton and inspect the contents. Damaged shipments should be reported to the carrier immediately and not returned until instructions are received. DO NOT return the goods to us unless you have received a return authorization. Claims made more than 14 days after receipt of shipment may be denied.

## Returns

Please call customer service at 770-832-9694 for a Return Authorization Number before returning any merchandise. Freight on returns must be paid by the purchaser. Absolutely no returns on "less than spool" or open stock quantities of rope or webbing products or custom/special order / non-stock items unless the item was received in a damaged condition. A sized product may be exchanged for a different size if the returned item is in a re-sellable condition. Any return that is due to a customer error is subject to a 15% re-stocking fee. Any eligible return will be credited only after a full inspection of the product is completed.

## Unconditional Guarantee

All merchandise offered in this catalog is returnable (in new condition) within 10 days, for any reason, for full refund credit less original shipping costs. CALL FOR RETURN AUTHORIZATION. Excludes cut lengths of rope or webbings and custom or special order products.

## Limited Warranty

RESCUE TECHNOLOGY warrants to the original purchaser that products manufactured and/or sold by RESCUE TECHNOLOGY will be free from defects in materials and workmanship. This expressed warranty and all implied warranties imposed by law are limited to one year duration from the date of purchase. RESCUE TECHNOLOGY will repair or replace any product returned under warranty if, in RESCUE TECHNOLOGY's judgment, the product has not been misused or altered. No further warranties exist or are implied by RESCUE TECHNOLOGY due to the high risks involved in rescue services and in outdoor activities such as, but not limited to, mountaineering, rock climbing, rappelling, or caving, which can be reduced only through the skill, training, and judgment of the individual participant. RESCUE TECHNOLOGY shall not be liable for any and all consequential damages arising out of the breach of the expressed or implied warranties on sales by RESCUE TECHNOLOGY products. This limited warranty in no way limits or alters other manufacturers' warranties on products that are sold or distributed by RESCUE TECHNOLOGY.

**NOTE: Some states do not allow limitation on how long an implied warranty lasts nor the exclusion or limitation of incidental or consequential damages, so the above limitations may not apply.**

## Liability Limits

Southeastern Safety Products, Inc. d/b/a Rescue Technology is not liable for any and all damages arising from abuse or improper use of equipment, failure to follow adequate safety precautions, or breach of the duty of either the purchaser, user, or bystander. Proper and adequate training, judgment, and competency are required to reduce the inherent risks in the use of rescue, safety and access equipment. The liability for the risks of use are solely that of the user and purchaser.

## Product Modifications

RESCUE TECHNOLOGY reserves the right to modify, without notice, the specifications and price of products described in this catalog and the terms of sale.

## RescueTECH Trademarks

Rigger, RT Rescue, Quadlock, ACCESS Lifelines, EGRESS Escape Rope, EGRESS-Hybrid Escape Rope, EGRESS-Nylon Escape Rope, PROBE Search Rope, PROBE-R Search Rope, PROBE-Hybrid Search Rope, PROBE-Nylon Search Rope, CORONA Escape Belt, VANGUARD, PRIME, and ADVANTAGE Rescue Harnesses are trademarks of Southeastern Safety Products, Inc. d/b/a RESCUE TECHNOLOGY.

## Other Trademarks

Kevlar and Nomex are registered trademarks of E.I. Dupont Co. D2 Escape Descender, D4 Rescue Belay Descender, RED Backup, Rocker, are trademarks of International Safety Components.

Copyright Januaryv 2013  
Rescue Technology  
Carrollton, GA 30117  
All rights reserved.



We proudly display this flag to designate equipment that is made in the U.S.A.



**RESCUE**  
**TECH** 1

**RESCUE TECHNOLOGY IS ACCESSIBLE VIA THE INTERNET.  
PLEASE VISIT OUR WEBSITE FOR LATEST PRODUCT  
INFORMATION:**

<http://www.rescuetechnology.com>

**You may E-Mail directly to: [info@rescuetechnology.com](mailto:info@rescuetechnology.com)**



## WARNING

Technical rescue and safety is potentially hazardous. Any person using equipment sold by RESCUE TECHNOLOGY in any manner is personally responsible for learning the proper techniques involved, and assumes all risks and accepts full and complete responsibility for any and all damages or injury of any kind, including death, which may result from the use of any RESCUE TECHNOLOGY equipment.

BPM  
PRSRT STD  
U.S. Postage  
Paid  
Carrollton, GA  
Permit No. 356

## **RescueTECH**

251 Beulah Church Road

Carrollton, GA 30117

Phone | 800.334.3368

Fax | 770.832.1676

[www.RescueTECH1.com](http://www.RescueTECH1.com)